

Welch Allyn Spot Vital Signs LXi

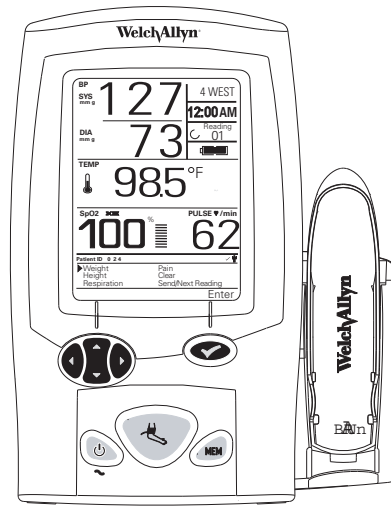
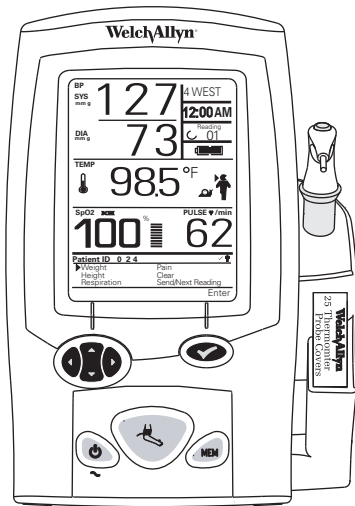

Service Manual

WelchAllyn®

Advancing Frontline Care™

Welch Allyn Spot Vital Signs LXi

Service Manual

WelchAllyn®

Advancing Frontline Care™

Copyright 2012 Welch Allyn. All rights are reserved. To support the intended use of the product described in this publication, the purchaser of the product is permitted to copy this publication, for internal distribution only, from the media provided by Welch Allyn. No other use, reproduction, or distribution of this publication, or any part of it, is permitted without written permission from Welch Allyn. Welch Allyn assumes no responsibility for any injury to anyone, or for any illegal or improper use of the product, that may result from failure to use this product in accordance with the instructions, cautions, warnings, or statement of intended use published in this manual.

Welch Allyn, Spot Vital Signs, SureBP Technology, and SureTemp are registered trademarks of Welch Allyn.

Braun ThermoScan is a registered trademark of the Braun Company.

LNCS is a trademark of, and SET, LNOP, and Masimo are registered trademarks of, Masimo Corporation. Possession or purchase of a Masimo SpO₂-equipped device does not convey any express or implied license to use the device with unauthorized sensors or cables which would, alone or in combination with this device, fall within the scope of one or more of the patents relating to this device.

Nellcor and *Oxi-Max* are registered trademarks of Nellcor Puritan Bennett Inc.

Health o meter is a registered trademark of Sunbeam Products, Inc. used under license.

Software in this product is Copyright Welch Allyn or its vendors. All rights are reserved. The software is protected by United States of America copyright laws and international treaty provisions applicable worldwide. Under such laws, the licensee is entitled to use the copy of the software incorporated with this instrument as intended in the operation of the product in which it is embedded. The software may not be copied, decompiled, reverse-engineered, disassembled, or otherwise reduced to human-perceivable form. This is not a sale of the software or any copy of the software; all right, title, and ownership of the software remain with Welch Allyn or its vendors.

For information about any Welch Allyn product, call Welch Allyn Technical Support:

USA	+1 800 289 2501	Australia	+61 2 9638 3000
Canada	+1 800 561 8797	China	+86 21 6327 9631
European Call Center	+353 46 90 67790	France	+33 15 5695 849
Germany	+49 695 098 5132	Japan	+81 3 6383 0852
Latin America	+1 305 669 9003	Netherlands	+31 202 061 360
Singapore	+65 6419 8100	South Africa	+27 11 777 7555
United Kingdom	+44 207 365 6780	Sweden	+46 85 853 6551

Reorder #4500-89

Manual Material No. 718440 Ver. A

Welch Allyn
4341 State Street Road
Skaneateles Falls, NY
13153 USA



Regulatory Affairs Representative
Welch Allyn Limited
Navan Business Park
Dublin Road
Navan, County Meath, Republic of Ireland

Printed in USA

WelchAllyn[®]

Advancing Frontline Care™

1 - Safety Summary	1
Introduction	1
Warnings and Cautions	1
General Warnings	1
Blood Pressure Warnings	3
Temperature Warnings	4
SpO ₂ Warnings	5
General Cautions	6
Blood Pressure Cautions	7
Temperature Cautions	7
SpO ₂ Cautions	7
Electrostatic Discharge (ESD)	8
Symbols	9
Safety Symbols	9
Button Symbols	9
Connection Symbols	9
Agency Symbols	10
2 - Overview	11
Purpose and Scope	11
Other Applicable Documents	11
Miscellaneous Mounting Accessories	12
Wall Mount Kit	12
Mobile Stand Kit	14
Radio Mounting Accessory	16
Barcode Reader Mounting Accessory	17
Warranty	18
Spot Vital Signs LXi	18
Accessories	18
Service	19
User Serviceable Parts	19
Technical Assistance	19
Field Replacement Units	19
Service Loaners	19
Service Intervals	19
Spot Vital Signs LXi Configurations	20
Controls	20
Display Window	22
Connections	24
Braun ThermoScan PRO 4000 Lock	25
Blood Pressure Hose and Cuff	25
Thermometer	26
SpO ₂ Sensor	27
Radio	27
Quick Reference Card	27
AC Power Transformer	28
Printer	28
Battery	29

3 - Functional Overview	31
Self Test	31
Internal Configuration Mode	32
4 - Spot Vital Signs LXi Technical Overview	37
System Description	37
Battery System	37
Battery Charger	37
"CPU I/O" Power Supply	37
Standby Mode	38
CPU Core Power Supply	38
+5V Supply	38
Clock/Calendar Power	38
Mod F NIBP Power	38
SpO ₂ and Thermometer Power	38
LCD Power	38
External Load (RS-232) Power	39
SureTemp Plus Thermometer Interface	39
Braun ThermoScan PRO 4000 Thermometer Interface	39
SpO ₂ Description	39
Radio Description	40
Bar Code Scanner Description	40
Interface	40
Printer Description	41
Interconnect Diagram	42
5 - Maintenance and Service	43
Cleaning	43
Spot Vital Signs LXi	43
Blood Pressure Cuff	43
Blood Pressure Hose and Cable	43
SureTemp Plus Thermometer	44
Braun ThermoScan PRO 4000 Thermometer	44
SpO ₂ Sensors	45
Radio	45
Printer	45
Battery Replacement	46
Spot Vital Signs LXi	46
Braun ThermoScan PRO 4000	46
Printer	47
Spot Vital Signs LXi Firmware Upgrade CD	48
Spot Vital Signs LXi Radio Configuration CD	48
Product Disposal	48
6 - Calibration and Verification	49
Terms	49
Required Test Equipment	50
Pneumatic test assembly setup	50
Power Supply Test Setup	52

Battery Removal / Power Shutdown	53
Voltage Calibration	55
Pressure verification test	57
Blood pressure calibration	62
NIBP board Initialization	62
Functional tests	67
Temperature Functional Check	77
Temperature test setup	77
Changing the Calibration Set Point Temperature on the 9600 Plus Calibration Tester	78
Welch Allyn SureTemp Plus Thermometers	78
Braun ThermoScan Pro 4000	82
Changing the Calibration Set Point Temperature	85
7 - Specifications	89
Performance	89
Blood Pressure Accuracy	89
Temperature Specifications	90
SpO ₂ Specifications	91
Masimo Sensor Accuracy Guide	91
Masimo Patents	91
Nellcor Sensor Accuracy Guide	92
Nellcor Patents	92
Mechanical	93
Electrical	93
Patents	93
Batteries	93
Environmental	93
Radio	94
Mechanical	94
Configuration Options	94
Guidance and Manufacturer's Declaration For Spot Vital Signs LXi Radio	95
8 - Troubleshooting	99
Error Codes	99
Radio Test	110
Service Work Checklist	111
Spot LXi Radio Configuration Tool	112
9 - Supplies and Accessories	113
Blood Pressure	113
Temperature	114
Pulse Oximetry	115
Masimo Accessories	115
Nellcor Accessories	117
Miscellaneous	118
Service Contracts	119

10 - Field Replaceable Units	121
11 - Disassembly and Repair	127
Tool list	127
Key Pad Disassembly	132
SpO ₂ Circuit Board Disassembly	133
Masimo	133
Nellcor	134
Blood Pressure Circuit Board Disassembly	136
LCD Inverter Ballast Board Disassembly	137
LCD Disassembly	137
Pump Disassembly	138
RS232-Communication Circuit Board Disassembly	138
Fan and Power Circuit Board Disassembly	139
Thermometry Circuit Board Disassembly	139
SureTemp Plus	139
Braun ThermoScan PRO 4000	141
12 - Repair Test Specifications	143
General Unit Test	143
A-D Noise Test	143
Leak Test	143
Inflation Test	143
Dump Test	143
Pneumatic Accuracy Test	143
Valve Control Test	144
Voltage Calibration	144
Blank Mode Current Test	144
Back Light (Idle) Current Test	144
Valve/Pump Mode Current Test	144
Interface Test	144
Temperature Option Requirements	144
Accuracy Test	144
Temperature Probe Test	145
SpO ₂ Option Requirements	145
SpO ₂ Functional Test	145
SpO ₂ Mode Current Test	145
Fail Safe Test	145
Over Pressure Test	145
Over 15 mmHg	145
Interconnect Diagram 1	147
Interconnect Diagram 2	148

1

Safety Summary

Introduction

All users of the Spot Vital Signs LXi must read and understand the safety summary, and all additional specific warnings and cautions located throughout the documentation.

Warnings and Cautions

Familiarize all operating personnel with the general safety information in this summary. Specific warnings and cautions are also found throughout this manual.

General Warnings

A warning statement in this manual identifies a condition or practice, which if not corrected or discontinued immediately, could lead to patient injury, illness, or death.

These warnings pertain entirely to Spot Vital Signs LXi.



WARNING The information in this manual is a comprehensive guide to the operation of Spot Vital Signs LXi. For best results, read this manual thoroughly before using the device.

WARNING Spot Vital Signs LXi is designed for medical clinician use. Although this manual may illustrate medical spot-check techniques, only a trained clinician who knows how to take and interpret a patient's vital signs should use this device.

WARNING Spot Vital Signs LXi is not intended for use in environments that are without health care practitioner supervision.

WARNING Spot Vital Signs LXi is not intended for continuous monitoring. **Do not leave the device unattended while taking measurements on a patient.**

WARNING To ensure data integrity, save readings and clear the Spot Vital Signs LXi display between patients.

WARNING The Spot Vital Signs LXi is not defibrillator proof.

WARNING Spot Vital Signs LXi is not intended for use during patient transport.

WARNING This device is not suitable for use in the presence of a flammable anesthetic mixture with air or oxygen or nitrous oxide. An explosion may result.



WARNING To ensure patient safety, use only accessories and supplies (i.e., cuffs, hoses, temperature probes, SpO₂ sensors, etc.) recommended for or supplied with Spot Vital Signs LXi. Using unapproved accessories with Spot Vital Signs LXi can affect patient and/or operator safety.

WARNING Prevent fluid from entering any connectors on the device. Should this occur, dry the connectors with warm air. Check the accuracy of all operating functions.

WARNING Every three months, inspect the blood pressure cuff, SpO₂ cable, and other accessories for fraying or other damage. Replace as necessary.

WARNING Do not use Spot Vital Signs LXi on patients who are on heart/lung machines.

WARNING Electric shock hazard. There are no user-serviceable parts inside Spot Vital Signs LXi other than battery replacement (see "Battery Replacement" on page 46). Only an individual specifically trained and approved for the repair and/or verification of this specific Welch Allyn product may perform maintenance procedures specifically described in this manual. For service, refer the device to an Authorized Service Center.

WARNING This device is not intended for hand-held use during operation.

WARNING Do not autoclave.

WARNING This device complies with current required standards for electromagnetic interference and should not present problems to other equipment or be affected by other devices. As a precaution, avoid using this device in close proximity to other equipment.

WARNING Welch Allyn is not responsible for the integrity of any mounting installation. Welch Allyn recommends that the customer contact their Biomedical Engineering Department or maintenance service to ensure professional installation for safety and reliability of any mounting accessory.

WARNING The Spot Vital Signs LXi consists of high-quality precision parts. Protect it from severe impact and shock. A qualified service technician must check any Spot Vital Signs LXi that is dropped or damaged for proper operation prior to further use. Do not use the Spot Vital Signs LXi if you notice any signs of damage. Contact the Welch Allyn Technical Support Department for assistance.

WARNING Do not use an SpO₂ finger clip sensor and a blood pressure cuff simultaneously on the same limb. Doing so may result in inaccurate pulse rate and perfusion readings.

WARNING All signal input and output (I/O) connectors are intended for connection of only devices complying with IEC 60601-1, or other IEC standards (for example, IEC 60950) as appropriate to the device. Connecting additional devices to the Spot LXi may increase leakage currents. To maintain operator and patient safety, it is necessary to consider the requirements of IEC 60601-1-1.

WARNING For proper patient electrical isolation, use only a Welch Allyn power supply (4500-101A) to charge Spot Vital Signs LXi.

WARNING Do not use the manufacturer supplied charger for the weight scale while it is attached to Spot LXi.

Blood Pressure Warnings

These warnings pertain to the Spot Vital Signs LXi blood pressure feature.



WARNING Spot Vital Signs LXi is not intended to measure BLOOD PRESSURE on neonatal patients. The AAMI SP10:2002 standard defines neonates as children 28 days or less of age if born at term (37 weeks gestation or more); otherwise up to 44 gestational weeks.

WARNING To ensure pediatric blood pressure accuracy and safety, the Child Reusable Two-Piece Blood Pressure Cuff (4500-01), Infant Durable One-Piece Cuff (5082-82-4MQ), and the Infant Disposable One-Piece Cuff (5082-92-4MQ) are the smallest cuffs approved for use with young children and infants. The child's arm must fit within the range markings on the cuff.

WARNING Avoid compression of the blood pressure hose or cuff tubing of Spot Vital Signs LXi. This may cause system errors to occur in the device.

WARNING Patients who are experiencing moderate to severe arrhythmias may give inaccurate blood pressure measurements.

WARNING Spot Vital Signs LXi does not operate effectively on patients who are experiencing convulsions or tremors.

WARNING Use only Welch Allyn blood pressure cuffs and/or hoses. Using other manufacturers' blood pressure cuffs and/or hoses may produce inaccurate blood pressure readings.

WARNING When several blood pressure measurements are taken on the same patient, regularly check the cuff site and extremity for possible ischemia, purpura, and/or neuropathy.

WARNING Do not place the cuff on any extremity that is used for intravenous infusions or any area where circulation is compromised.

WARNING Excessive cuff tightness may cause venous congestion and discoloration of the limb.

WARNING Wrapping the cuff too loosely (preventing proper inflation) may result in errors.

WARNING Do not change the connector(s) on the blood pressure cuff tubing of this device to luer type. Luer type connectors are commonly used in intravenous infusion systems. Using the luer connectors on blood pressure cuff tubing creates the risk that the blood pressure tubing could be mistakenly connected to a patient's intravenous line, resulting in the introduction of air into the patient's circulatory system.

Temperature Warnings

These warnings pertain to the Spot Vital Signs LXi temperature feature.

SureTemp® Plus

These warnings are specific to the SureTemp Plus thermometer option.



WARNING Use only Welch Allyn probe covers. Using other manufacturers' probe covers or no probe cover may produce temperature measurement errors and/or inaccuracy.

WARNING Always use a probe cover whenever coming into contact with a patient.

WARNING Long-term continuous monitoring beyond three to five minutes is not recommended in any mode.

WARNING Oral/axillary probes (blue ejection button at top of probe) and blue removable probe wells are used for taking oral and axillary temperatures only. Rectal probes (red ejection button) and red removable probe wells are used for taking rectal temperatures only. Use of the probe at the wrong site will result in temperature errors. Use of the incorrect removable probe well could result in patient cross-contamination.

WARNING The thermometer connectors and probe are not waterproof. Do not immerse or drip fluids on these items. Should this occur, dry the connectors and probe with warm air. Check all functions for proper operation and accuracy.

WARNING Do not take an axillary temperature through patient's clothing. Direct probe cover to skin contact is required.

WARNING Do not autoclave.

WARNING Use Welch Allyn single-use disposable probe covers to limit patient cross-contamination.

WARNING Incorrect insertion of probe can cause bowel perforation.

WARNING Washing hands greatly reduces the risk of cross-contamination and nosocomial infection.

WARNING To ensure optimal accuracy, always confirm that the correct mode is selected.

Braun ThermoScan PRO 4000

These warnings are specific to the Braun ThermoScan PRO 4000 thermometer option.



WARNING Keep the probe window clean, dry, and undamaged at all times to ensure accurate measurements. To protect the probe window, always keep the thermometer in the storage cover while transporting or when not in use.

WARNING Only use Braun ThermoScan probe covers with this thermometer. Using other manufacturer's probe covers or no probe cover may produce temperature measurement errors and/or inaccuracies. If the thermometer is used without a probe cover attached, clean the lens (see "Braun ThermoScan PRO 4000 Thermometer" on page 44).

WARNING Do not autoclave.

WARNING The thermometer is not waterproof. Do not immerse or drip fluids on it. Should this occur, dry the thermometer with warm air. Check for proper operation and accuracy.

SpO₂ Warnings

These warnings pertain to the Spot Vital Signs LXi SpO₂ feature.



WARNING Only use Spot Vital Signs LXi with Masimo or Nellcor SpO₂ option with Masimo or Nellcor brand sensors and accessories, respectively. Using the wrong or unapproved sensors or cables may cause improper performance.

WARNING The SpO₂ sensor and extension cables are intended for use only for pulse oximetry measurements. Do not attempt to connect these cables to a PC or any similar device.

WARNING Before using, carefully read the sensor Directions for Use, including all warnings, cautions, and instructions.

WARNING Do not use a damaged sensor or pulse oximetry cable or a sensor with exposed optical components.

WARNING Incorrect application or a long duration of use of an SpO₂ sensor may cause tissue damage. Inspect the sensor site periodically as directed in the sensor's Directions for Use.

WARNING Certain ambient environmental conditions, sensor application errors, and certain patient conditions may affect SpO₂ readings and pulse signal.

WARNING Do not immerse the sensor or patient cables in water, solvents, or cleaning solutions (the sensors and connections are not waterproof). Do not use irradiation, steam, or ethylene oxide for sterilization.

WARNING The SpO₂ in the Spot Vital Signs LXi device is not intended for use as an apnea monitor.

WARNING Consider the SpO₂ an early warning device. As a trend toward patient deoxygenation is indicated, use laboratory instruments to analyze blood samples to completely understand the patient's condition.



WARNING Tissue damage can be caused by incorrect application or duration of use of a Nellcor OxiMax sensor. Inspect the sensor site as directed in the sensor Directions for Use.

WARNING Do not use the sensors during magnetic resonance imaging (MRI) scanning. Induced current could potentially cause burns. The MS board pulse oximeter may affect the MRI image, and the MRI unit may affect the accuracy of the oximetry measurements.

WARNING Carefully route patient cabling to reduce the possibility of patient entanglement or strangulation.

WARNING Failure to cover the Nellcor OxiMax sensor site with opaque material in high ambient light conditions may result in inaccurate measurements.

General Cautions

A caution statement in this manual identifies a condition or practice, which if not corrected or discontinued immediately, could lead to equipment failure, equipment damage, or data loss.

These cautions pertain to the entire Spot Vital Signs LXi device.



Caution If the accuracy of any measurement is in question, check the patient's vital sign(s) with an alternate method and then check to verify the device is functioning properly.

Caution Place the device on a secure surface or use one of the optional mounting accessories.

Caution Do not place fluids on or near the device.

Caution It is recommended that the device is used within stated operating temperature ranges (see "Environmental" on page 93). The device will not meet its performance specifications if used outside these temperatures ranges.

Caution Always unplug the AC power transformer from the outlet before moving the mobile stand to a new location.

Caution The basket has a three-pound weight limit. Take care not to exceed this limit.

Caution When connecting a Health o meter[®] weight scale, only operate the scale with battery power. Remove and discard the scale's AC power cord.

Caution When using the Health o meter scale, remove the two hex nuts on the RS-232 cable, as supplied, before screwing the cable into the scale base.

Blood Pressure Cautions

These cautions pertain to the Spot Vital Signs LXi blood pressure feature.



Caution Minimize extremity and cuff motion during blood pressure readings.

Caution If the blood pressure cuff is not at heart level, note the difference in reading due to the hydrostatic effect. Add the value of 1.80 mmHg (.2 kPa) to the displayed reading for every inch (2.5 cm) above heart level. Subtract the value of 1.80 mmHg (.2 kPa) from the displayed reading for every inch (2.5 cm) below heart level.

Caution Proper blood pressure cuff size and placement is essential to the accuracy of the blood pressure determination. See Reusable Two-Piece Cuff Measurements or Durable One-Piece Cuff Measurements of the Directions for Use for sizing information.

Caution The position and physiologic condition of the subject can affect a blood pressure reading.

Temperature Cautions

These cautions pertain to the Spot Vital Signs LXi temperature feature.



Caution The SureTemp Plus feature only operates with the probe well in place.

Caution Do not use alkaline batteries in the Braun ThermoScan PRO 4000.

Caution Biting the probe tip may result in damage to the probe.

SpO₂ Cautions

These cautions pertain to the Spot Vital Signs LXi SpO₂ feature.



Caution The pulse oximeter is calibrated to determine the percentage of arterial oxygen saturation of functional hemoglobin. Significant levels of dysfunctional hemoglobin such as carboxyhemoglobin or methemoglobin may affect the accuracy of the measurement.

Caution Some sensors may not be appropriate for a particular patient. If at least 10 seconds of perfusion pulses cannot be observed for a given sensor, change sensor location or sensor type for perfusion to resume.

Caution Physiological conditions, medical procedures, or external agents that may interfere with the pulse oximeter's ability to detect and display measurements include dysfunctional hemoglobin, arterial dyes, low perfusion, dark pigment, and externally applied coloring agents such as nail polish, dye, or pigmented cream.

Caution When selecting a sensor, consider the patient's weight and activity level, the adequacy of perfusion, the available sensor sites, the need for sterility, and the anticipated duration of monitoring.

Electrostatic Discharge (ESD)



Electrostatic discharge is a sudden current flowing from a charged object to another object or to ground. Electrostatic charges can accumulate on common items such as foam drinking cups, cellophane tape, synthetic clothing, untreated foam packaging material, and untreated plastic bags and work folders, to name only a few.

Electronic components and assemblies, if not properly protected against ESD, can be permanently damaged or destroyed when near or in contact with electrostatically charged objects. When you handle components or assemblies that are not in protective bags and you are not sure whether they are static-sensitive, assume that they are static-sensitive and handle them accordingly.















- Perform all service procedures in a static-protected environment. Always use techniques and equipment designed to protect personnel and equipment from electrostatic discharge.
- Remove static-sensitive components and assemblies from their static-shielding bags only at static-safe workstations - a properly grounded table and grounded floor mat - and only when you are wearing a grounded wrist strap (with a resistor of at least 1 megohm in series) or other grounding device.
- Use only grounded tools when inserting, adjusting, or removing static-sensitive components and assemblies.
- Remove or insert static-sensitive components and assemblies only with monitor power turned off.
- Insert and seal static-sensitive components and assemblies into their original static-shielding bags before removing them from static-protected areas.

Always test your ground strap, bench mat, conductive work surface, and ground cord before removing components and assemblies from their protective bags and before beginning any disassembly or assembly procedures.





Symbols

The following symbols are associated with the Spot Vital Signs LXi.

Safety Symbols

	Identifies information within the manual to avoid injury.		Identifies information within the manual to avoid equipment failure.
	Caution: consult accompanying documents		Internally Powered, Lead Acid Battery
	Handle with Care		Transport Temperature
	Storage Humidity		Recycle
	Class II Equipment	IPX0	Equipment is not protected against the ingress of liquid.
	Type BF Equipment		On/Off
	Recycle the product separate from other disposables, see "Product Disposal" on page 48.		Non-ionizing radiation (RF transmitter)
	Mode of Operation: Continuous		DC Power In

Button Symbols

	Navigation Buttons		Select
	Blood Pressure		Memory
	Power On/Off		

Connection Symbols

	USB Connection		Serial Port Connection
---	----------------	--	------------------------

Agency Symbols

CONFORMS TO:
UL STD 60601-1

IEC 60601-1



The CE mark on this product indicates that it has been tested to and conforms with the provisions noted within the 93/42/EEC Medical Device Directive.

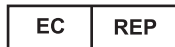

Regulatory Affairs Representative
Welch Allyn Limited
Navan Business Park
Dublin Road
Navan, County Meath, Republic of Ireland

2

Overview

Purpose and Scope

The Spot Vital Signs LXi Service Manual is intended as a reference for maintenance and repair to the field replaceable unit (FRU) level and are listed on [page 121](#).

Note Opening the Spot Vital Signs device case requires recalibration of specific functions. This includes any internal components that were replaced. Calibration requires the use of the Welch Allyn Spot LXi Tool.

This manual provides the technical qualified service person with troubleshooting information, repair procedures, and calibration and performance verification instructions. A technical overview of the Spot Vital Signs LXi subsystems is provided as an introduction to the device's circuitry and pneumatics.

This manual is intended for the technical qualified service personnel. Service training classes on Welch Allyn's products are available. Contact Welch Allyn Technical Support for information.

Other Applicable Documents

The Spot Vital Signs LXi Directions for Use manual is also available. Refer to this document for information other than maintenance and repair.

Welch Allyn 9600 Plus Calibration Tester Directions for Use - for all models.

Braun ThermoScan PRO 4000 User's Guide - for models 450E0, 45NE0, 45ME0.

Masimo Directions for Use - for models 45MT0, 45ME0.

Nellcor Directions for Use - for models 45NT0, 45NE0.

Miscellaneous Mounting Accessories

Wall Mount Kit

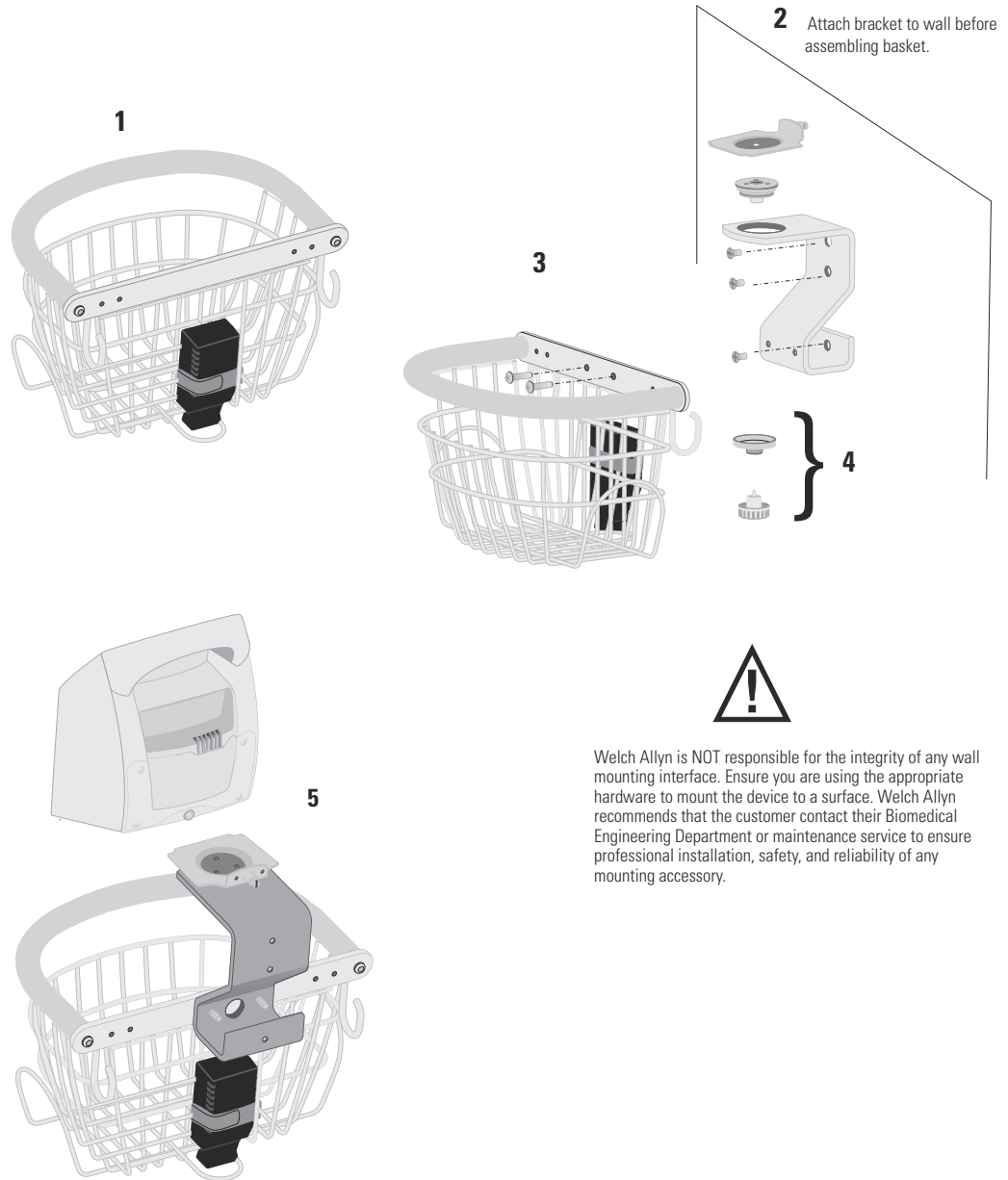

PARTS LIST			
ITEM	DESCRIPTION	QTY	P/N
1	BASKET	1	MIS-1574M
2	AC ADAPTER STRAP	1	STL-1534
3	ADAPTER BLOCK	1	PLS-1497
4	BLOCK CAP	1	STL-1534
5	SCREW	2	SCR-1464

UTILITY BASKET
12.00" X 8.12" X 7.00"

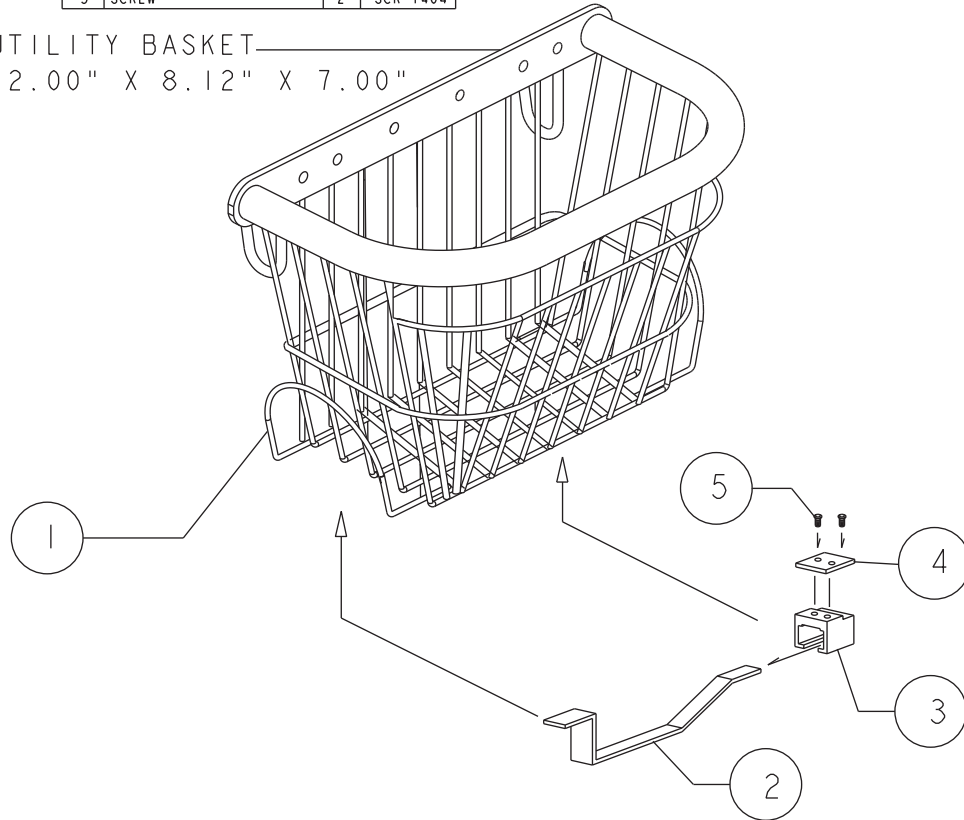

WALL MOUNT BASKET WITH GRAY EPOXY FINISH. SPACE SAVING UNDER MOUNT AC ADAPTER HOLDER.
BULK SHIPPING PACK OF 8 UNITS. SHIPPING BOX IS 27.00" X 18.00" X 18.00" SHIPPING WEIGHT IS 15 LBS.
ITEM 1 TO BE PLACED IN A POLY BAG, ITEMS 2-5 TO BE PLACED IN A POLY BAG.

Mobile Stand Kit

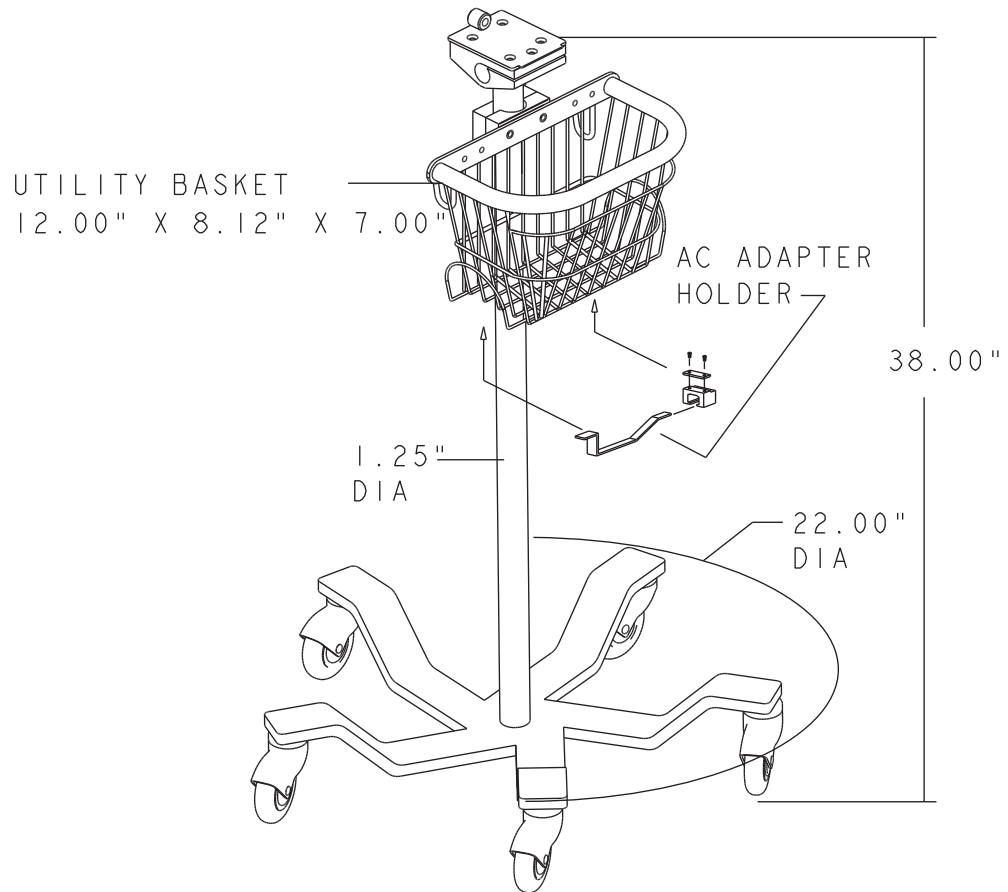

5-LEG, 22" DIAMETER LOW CENTER-OF-GRAVITY DETACHABLE BASE, WITH 3" SOFT RUBBER CASTERS, 2 EA. LOCKING. GRAY EPOXY FINISH. DETACHABLE POLE ASSEMBLY WITH GRAY BASKET AND HANDLE, WITH TILT MOUNT, AND WITH DEVICE MOUNTING PLATE. SHIPPING BOX IS 40.00" X 21.50" X 12.50". SHIPPING WEIGHT IS 31 LBS.

NOTE: ALL DIMENSIONS ARE IN INCHES.

PARTS LIST			
ITEM	DESCRIPTION	QTY	P/N
1	STEEL BASE	1	STL-1005
2	STUD	5	SCR-1258
3	CASTER	3	CAS-1151
4	ESNA NUT	5	SCR-1257
5	WASHER	5	SCR-1341
6	LOCKING CASTER	2	CAS-1163
7	WASHER	1	SCR-1274
8	HEX BOLT	1	SCR-1349
9	TAPERED PIN	1	STL-1032
10	BASE POLE	1	TUB-1268
11	BUSHING	1	PLS-1436
12	BASKET	1	MIS-1574M
13	MOUNT	1SET	PLS-1496
14	TUBE	1	TUB-1202
15	END CAPS	2	MIS-1461
16	SCREW	1	SCR-1567
17	SWIVEL MOUNT	1	PLS-1470
18	SCREWS	3	SCR-1356
19	MOUNT PLATE	1	PLS-1502
20	KNOB	1	KNB-1339
21	RETAINING WASHER	1	SCR-1575
22	SCREW	2	SCR-1295
23	WASHER	2	SCR-1402
24	ACORN NUT	2	SCR-1372
25	SCREW	2	SCR-1559
26	WASHER	2	SCR-1402
27	ESNA NUT	2	SCR-1371
28	AC ADAPTER STRAP	1	STL-1534
29	ADAPTER BLOCK	1	PLS-1497
30	BLOCK CAP	1	STL-1534
31	SCREW	2	SCR-1464
32	MFG LABEL	1	LBL-1526
NOT SHOWN	TAMPER PROOF HEX KEY	1	SCR-1320
NOT SHOWN	TAMPER PROOF SCREW	1	SCR-1574
PACKAGING	CARTON	1	PAC-1530
PACKAGING	INSERT	1	PAC-1535
PACKAGING	BASE BOX	1	PAC-1536
PACKAGING	BASKET BOX	1	PAC-1537
PACKAGING	STYROFOAM INSERTS	2	PAC-1538
PACKAGING	INSTRUCTION SHEET	1	LBL-1948

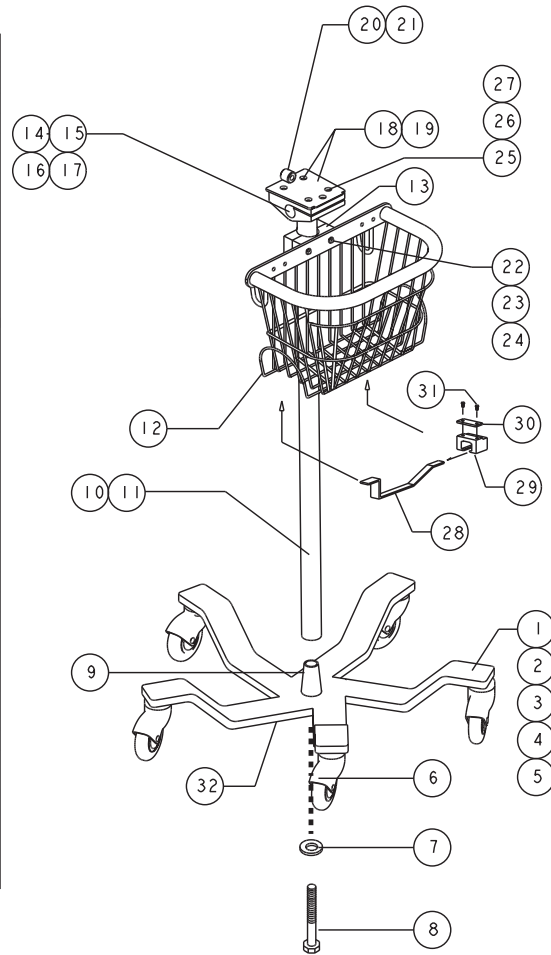

TORQUE ITEM 27 TO 8 - 10 in lbs.
 BAG ITEMS 7,8 AND 28 - 31, ALONG WITH TAMPER PROOF KEY AND SCREW.

Radio Mounting Accessory

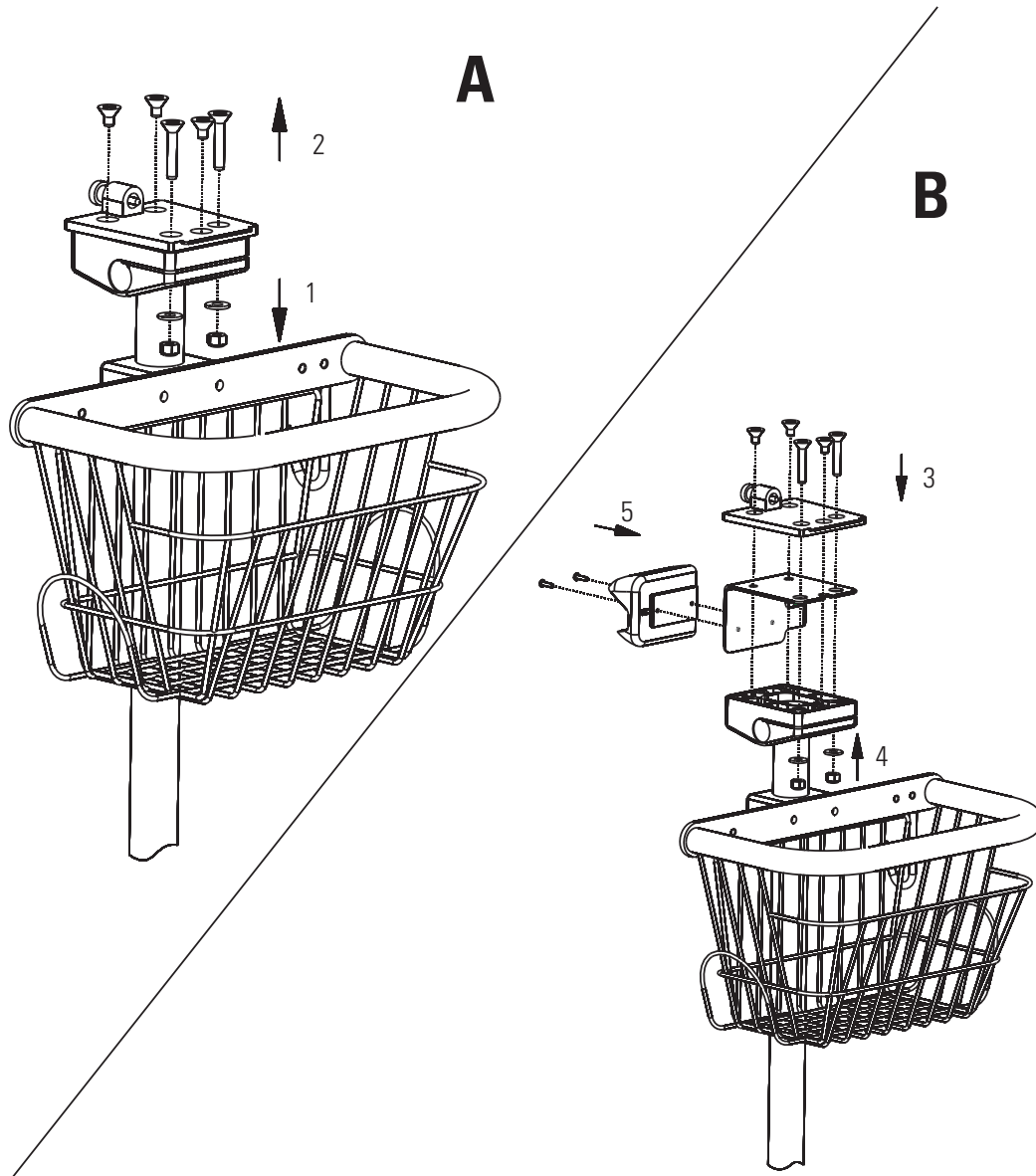

Barcode Reader Mounting Accessory

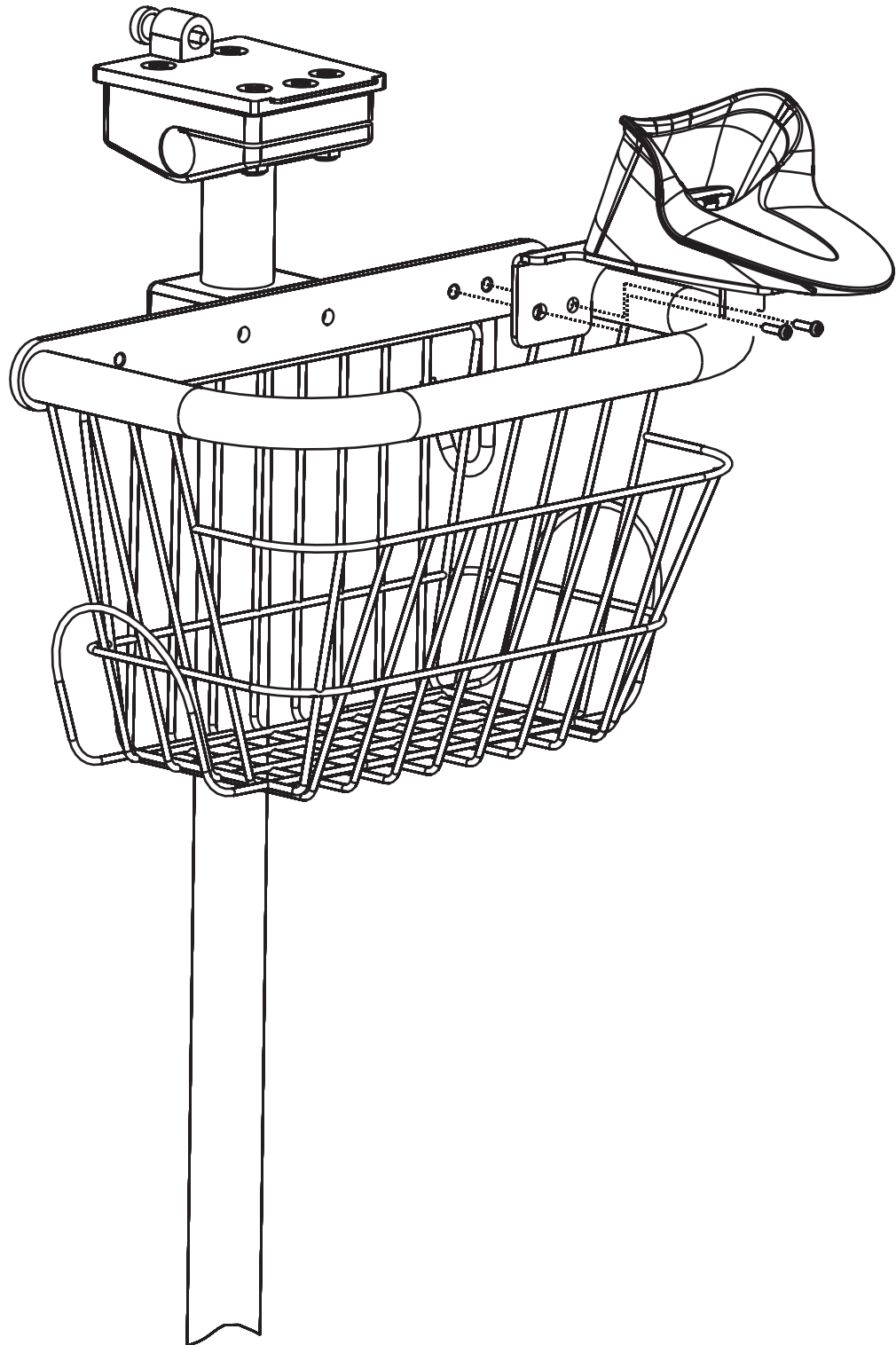

Warranty

Spot Vital Signs LXi

Welch Allyn warrants that the Spot Vital Signs LXi Radio products meet the labeled specifications of the products and will be free from defects in materials and workmanship that occur within one year after the date of purchase.

The date of purchase is: 1) the date specified in our records if you purchased the Product directly from us, 2) the date specified in the warranty registration card that we ask you to send to us, or 3) the date of purchase of product from the authorized Welch Allyn distributor as documented from a receipt from said distributor.

This warranty does not cover damage caused by: 1) handling during shipping, 2) use or maintenance contrary to labeled instructions, 3) alteration or repair by anyone not authorized by Welch Allyn, and 4) accidents.

If a Product or accessory covered by this warranty is determined to be defective because of defective materials, components, or workmanship, and the warranty claim is made within the warranty period described above, Welch Allyn will, at its discretion, repair or replace the defective Product or accessory free of charge.

You must obtain a service notification number from Welch Allyn to return your Product before you send it to Welch Allyn's designated service center for repair. Contact Welch Allyn Technical Support.

THIS WARRANTY IS IN LIEU OF ALL OTHER WARRANTIES, EXPRESS OR IMPLIED, INCLUDING BUT NOT LIMITED TO THE IMPLIED WARRANTIES OF MERCHANTABILITY AND FITNESS FOR A PARTICULAR PURPOSE. WELCH ALLYN'S OBLIGATION UNDER THIS WARRANTY IS LIMITED TO REPAIR OR REPLACEMENT OF PRODUCTS CONTAINING A DEFECT. WELCH ALLYN IS NOT RESPONSIBLE FOR ANY INDIRECT OR CONSEQUENTIAL DAMAGES RESULTING FROM A PRODUCT DEFECT COVERED BY THE WARRANTY.

Accessories

Refer to the manufacturer's Directions for Use for the Masimo and Nellcor finger sensor and cable warranty.

Refer to the Directions for Use provided with the Welch Allyn Blood Pressure Cuff for warranty information.

The SureTemp Plus probe is covered by a one-year warranty and the SureTemp Plus probe well is covered by a 90-day warranty against original defects in material and workmanship. Probe covers are intended for single-use only.

The Braun ThermoScan PRO 4000 is covered by a three-year warranty against original defects in material or workmanship.

The printer is covered by a one-year warranty against original defects in material or workmanship.

The barcode scanner is covered by a five-year warranty against original defects in material or workmanship.

Service



Caution Unauthorized repairs will void the warranty.

All repairs on products under warranty must be completed by Welch Allyn or Welch Allyn certified service personnel in accordance with warranty guidelines. See the Welch Allyn Partners In Care™ web site (<http://www.welchallyn.com/promotions/services/default.htm>) for a description of the different levels of services offered.

User Serviceable Parts

For user serviceable parts available see “Supplies and Accessories” on page 113.

Technical Assistance

If you have an equipment problem that you cannot resolve, call the Welch Allyn Service Center nearest you for assistance. Technical service telephone support is available on normal business days.

If you are advised to return a product to Welch Allyn for repair or routine maintenance, schedule the repair with the service center nearest you.

Before returning a product for repair, you must obtain authorization from Welch Allyn. Service personnel will give you a Service Notification number. Please note this number on the outside of your shipping box. Returns without a Service Notification number will not be accepted for delivery.

Field Replacement Units

See “Field Replaceable Units” on page 121.

Service Loaners

Service loaners or exchanges may be provided depending on the specific Partners In Care™ agreement in place for the device. Loaners for products repaired while under the original warranty, may be provided free of charge and are shipped within 48 hours of notification of need.

For service repairs outside of warranty or outside of service agreement are available for a nominal charge and shipment is subject to availability. Loaners are shipped pre-paid; however, this charge is added to the service charges.

Service Intervals

Calibrate the Spot Vital Signs LXi on an annual basis for blood pressure, temperature, and SpO2 accuracy.

Spot Vital Signs LXi Configurations

Table 1. Available Versions of Spot Vital Signs LXi

REF	Description
450T0	SureBP with SureTemp Plus Thermometer
450E0	SureBP with Braun ThermoScan PRO 4000 Thermometer
45MT0	SureBP with Masimo SpO ₂ and SureTemp Plus Thermometer
45ME0	SureBP with Masimo SpO ₂ and Braun ThermoScan PRO 4000 Thermometer
45NT0	SureBP with Nellcor SpO ₂ and SureTemp Plus Thermometer
45NE0	SureBP with Nellcor SpO ₂ and Braun ThermoScan PRO 4000 Thermometer

Controls

Figure 1. Spot Vital Signs LXi Front Panel with SureTemp Plus Thermometer

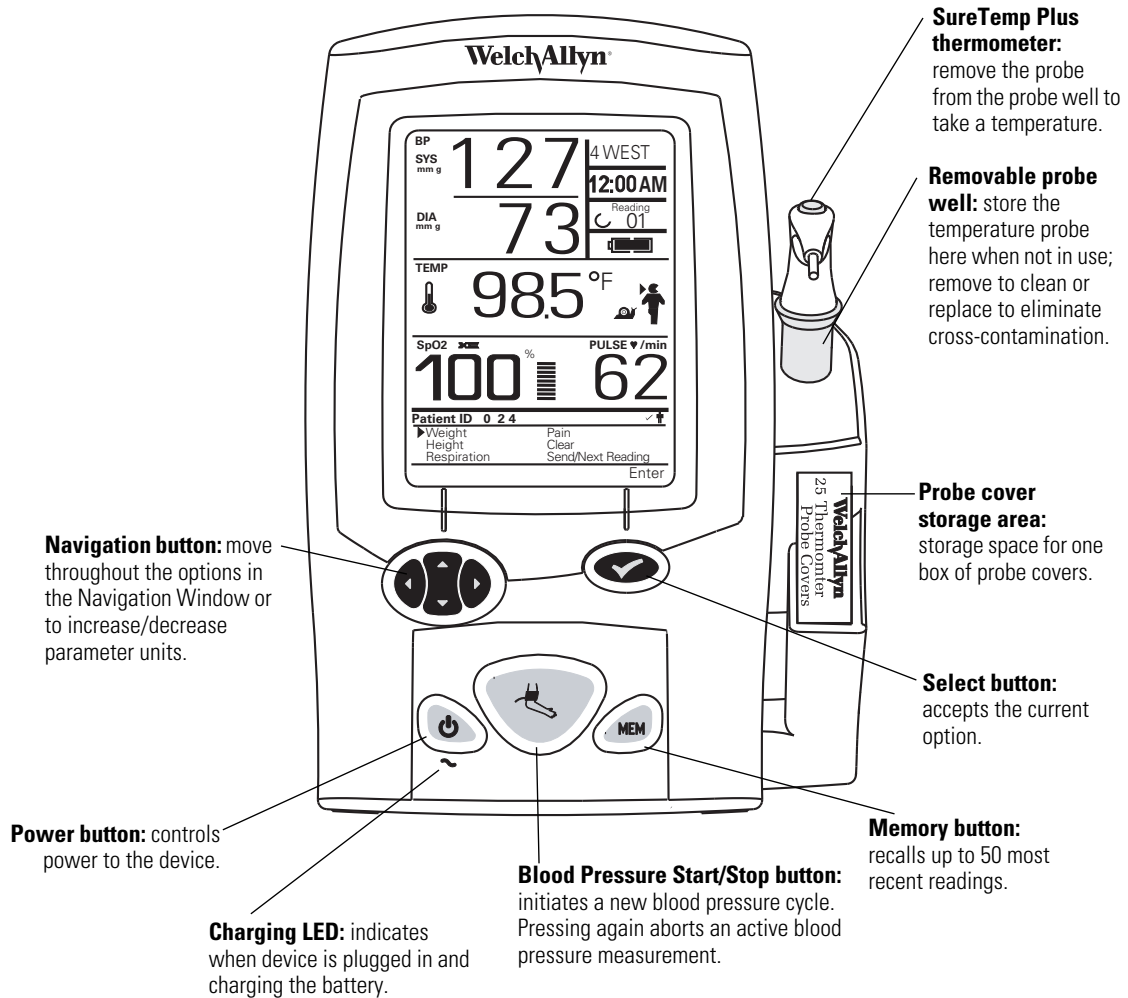
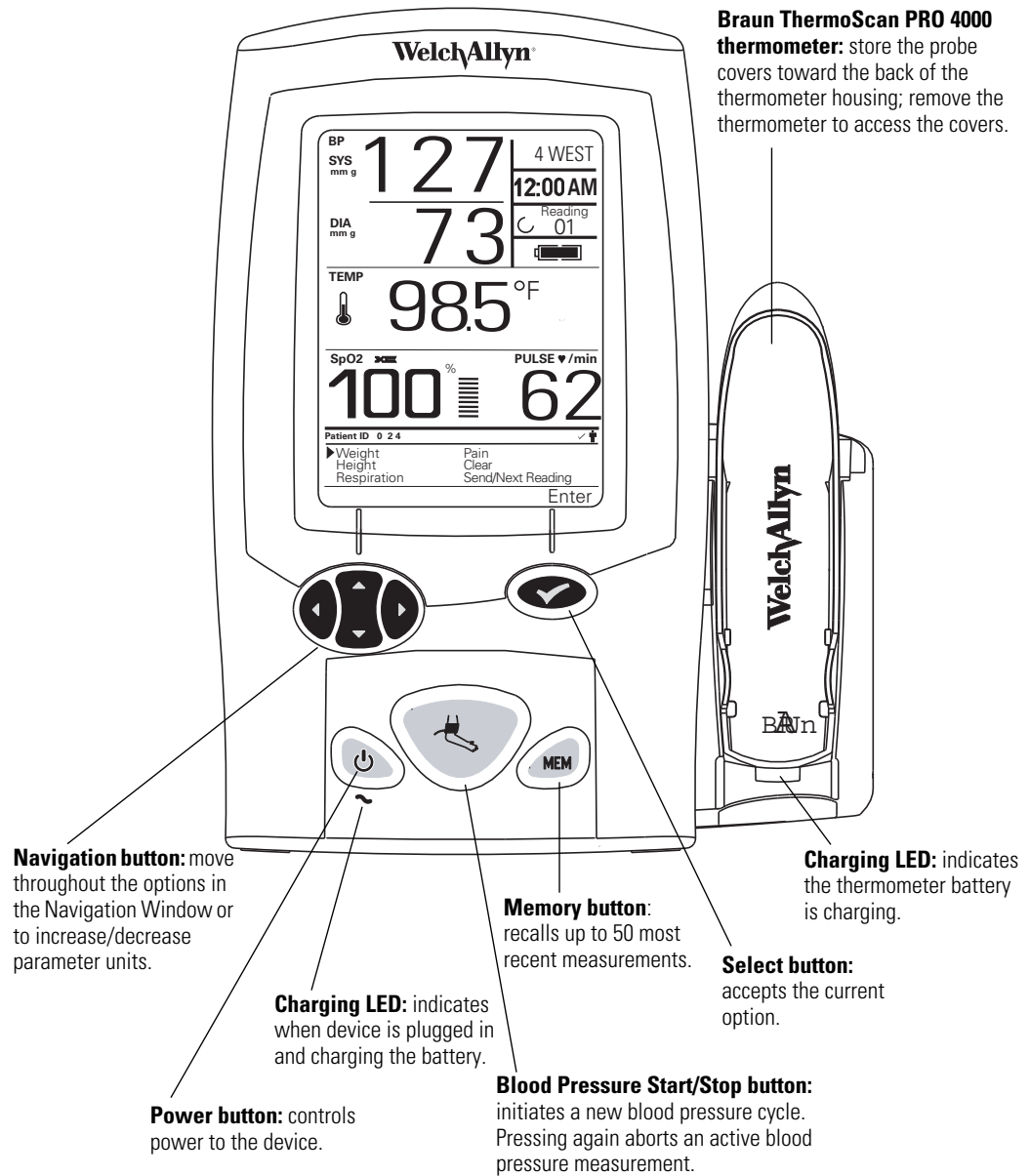

Figure 2. Spot Vital Signs LXi Front Panel with Braun ThermoScan PRO 4000 Thermometer



Display Window

Note Before using Spot Vital Signs LXi for the first time, you must program it using the initial configuration screen.

1. Press the **Power** button. The display window shows the initial configuration screen.

Figure 3. Initial Configuration Screen

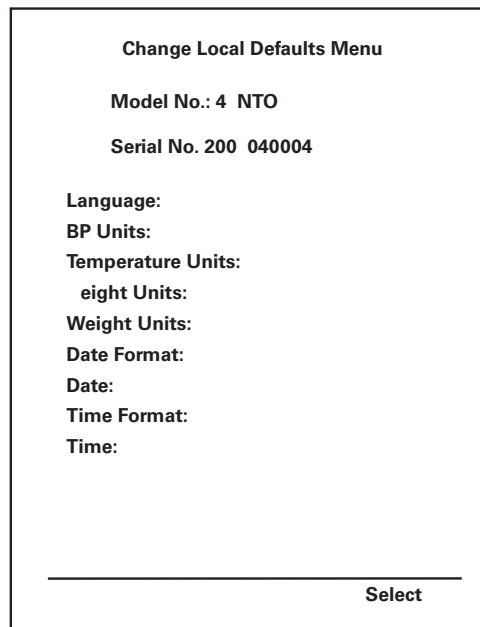

2. Use the **Select** button to access the options and accept the entries, and use the **Navigation** buttons to move through the menu.
3. The word "Exit" appears at the bottom of the list after you have programmed all items in the menu. You must program all items before you can start to use the device.
4. Scroll to Exit and press the **Select** button to save the entries.

The liquid crystal display (LCD) may indicate any of the following: systolic blood pressure (mmHg or kPa), diastolic blood pressure (mmHg or kPa), MAP (mmHg or kPa), temperature (°F or °C), temperature mode, pulse rate, pulse signal level, SpO₂ percent, department location, date, time, record number, height (in or cm), weight (lb or kg), respiration rate, pain level, connectivity signal strength, and battery charge level.

Figure 4. Display Window

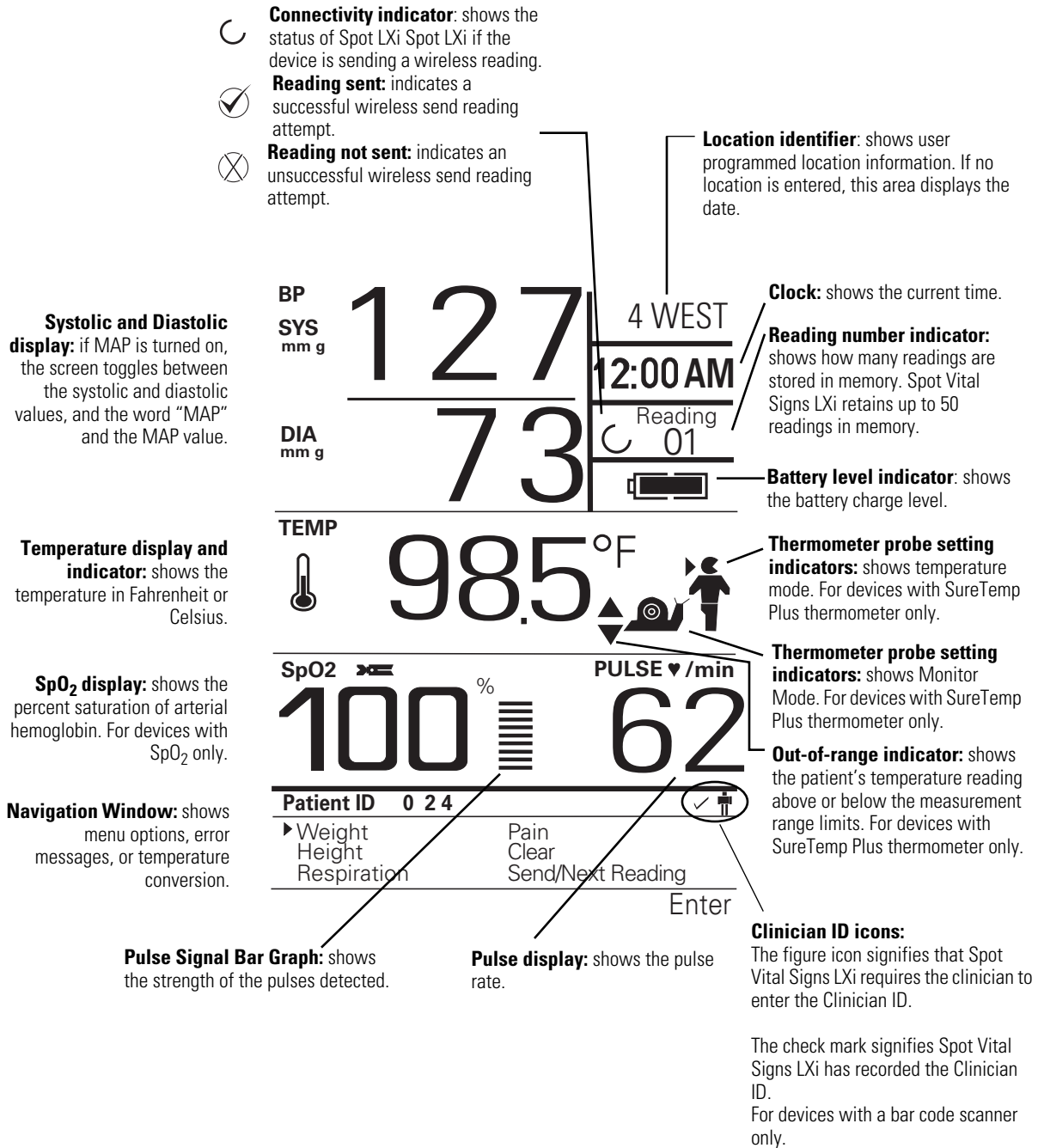

Connections

Use the following instructions to connect the blood pressure hose, thermometer probe, and optional attachments to the Spot Vital Signs LXi.

Figure 5. Spot Vital Signs LXi Side and Rear Panel Connections

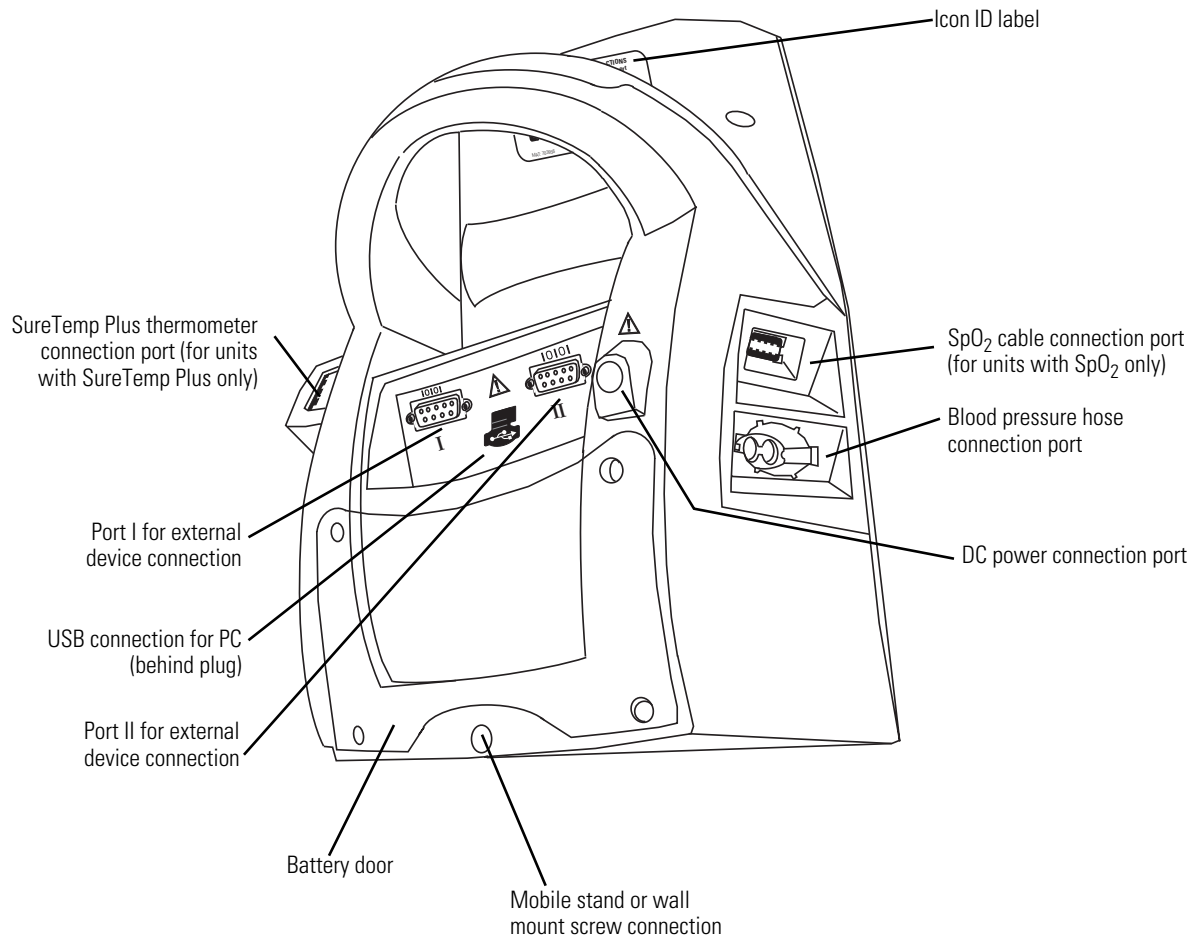

Braun ThermoScan PRO 4000 Lock

Press the lock tab toward the Braun ThermoScan PRO 4000 thermometer until it clicks. To release the housing, insert the lock release pin into the lock release hole until the lock tab snaps back.

Figure 6. Spot Vital Signs LXi with Braun ThermoScan PRO 4000 Lock

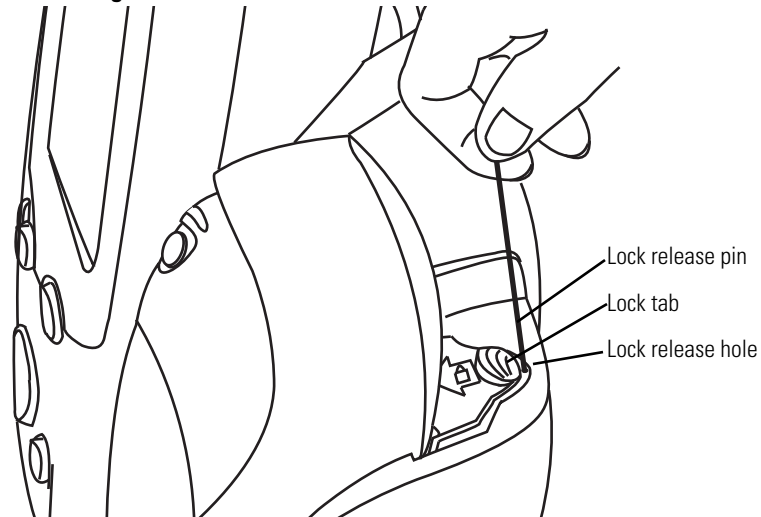

Blood Pressure Hose and Cuff

Identify and have available the Spot Vital Signs LXi, blood pressure cuff, and the blood pressure hose.

1. Inspect the blood pressure hose; notice that one end has a single, gray connector fitting and the other end has two white fittings.
2. Squeeze the side tabs on the gray connector and completely push the blood pressure hose connector into the blood pressure hose connection port until it clicks into place (see [Figure 5](#) on page 24).
3. Twist the white connectors on the blood pressure hose and cuff connectors together.

Thermometer

Spot Vital Signs LXi is available with either the SureTemp Plus thermometer or the Braun ThermoScan PRO 4000 thermometer.

SureTemp Plus

SureTemp Plus is available with two probes and matching wells; one for oral/axillary temperatures (blue ejection button and probe well) and one for rectal temperatures (red ejection button and probe well).



WARNING Always use a probe cover whenever coming into contact with a patient.



Caution The SureTemp Plus feature only operates with the probe well in place.

1. Align the probe well with the tabs facing up and down into the round opening of the SureTemp Plus housing on the right side of Spot Vital Signs LXi. Push it into place.
2. Align the temperature probe connector with the SureTemp Plus thermometer connection port on the back of the Spot Vital Signs LXi (see [Figure 5](#) on page 24). You can only insert the connector into the port one way.
3. Press the tab on the connector and push it until it clicks into place.
4. Insert the temperature probe into the probe well.

Braun ThermoScan PRO 4000



Caution Do not use alkaline batteries in the Braun ThermoScan PRO 4000 thermometer. Use the rechargeable battery pack supplied by Welch Allyn.

1. Open the package of rechargeable batteries and follow the installation guide provided.
2. Open the box of probe covers as directed on the box and slide the box into the metal guides toward the back of the thermometer housing with the opening at the top and perforation facing forward.
3. Hold the Braun thermometer at a 45° angle then insert the probe and the top of the thermometer into the housing.
4. Lower the bottom portion of the thermometer into the housing until it snaps into place. If you do not properly seat the thermometer, it could fall out of the holder and become damaged.
5. Slide the thermometer housing into the thermometer slot on the right side of the Spot Vital Signs LXi device.
6. Push the lock tab forward to prevent the thermometer housing from falling out of Spot Vital Signs LXi (see [Figure 6](#) on page 25).

To release the lock, insert the lock release pin into the lock release hole.

SpO₂ Sensor

Spot Vital Signs LXi is available with a wide variety of SpO₂ sensors and ships with a reusable finger clip sensor.

1. Align the shape and pin configuration of the extension cable connector to the SpO₂ cable connection port on the left side of the Spot Vital Signs LXi device.
2. Push the connector firmly into the SpO₂ cable connection port until you hear it click into place (see [Figure 5](#) on page 24).
3. Align the opposite end of the extension cable to the sensor cable connector and firmly push them together.



WARNING Use only Masimo or Nellcor SpO₂ sensors and accessories with the Spot Vital Signs LXi with Masimo or Nellcor configurations, respectively. Using the wrong or unapproved sensors or cables may cause improper performance.

Radio

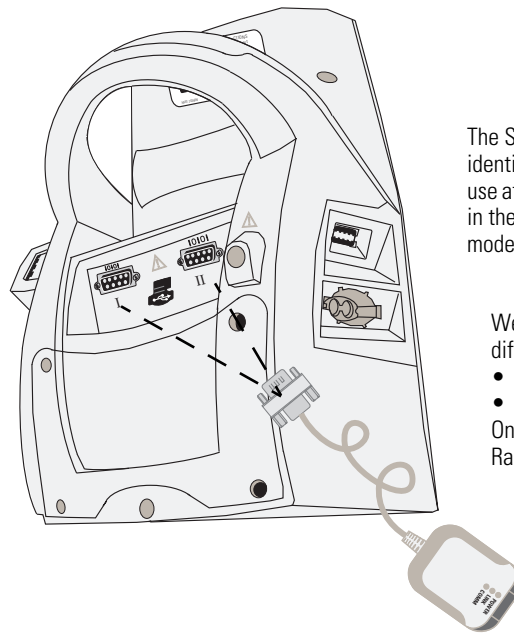

The Spot Vital Signs LXi identifies which serial port to use after activating the Radio in the internal configuration mode.

Welch Allyn offers two different radios:

- 802.11b radio and
- 802.11a/b/g radio

Only use Welch Allyn Radios

Quick Reference Card

Attach the Quick Reference Card to the Spot Vital Signs LXi handle, mobile stand, or wall mount using the supplied plastic cable tie.

AC Power Transformer

Note To assure proper electrical isolation use only the Welch Allyn SPOT Vital Signs AC power transformer/charger.

The operator can use the Spot Vital Signs LXi with AC or battery power (after charging the battery).

1. Insert the round transformer connector into the AC power connection port on the back of the Spot Vital Signs LXi (see [Figure 5](#) on page 24).
2. Insert the line cord into the line connector on the transformer then plug the power cord on the transformer into the AC main power source to charge the battery.

Printer

Once the printer is enabled in the Internal Configuration Mode, you can use plain or label paper. If you use label paper, you must clean the printer heads after every 10 rolls. A head cleaner kit is provided with each package of label paper available from Welch Allyn.

To connect the printer to the Spot LXi:

1. Connect the the large end of the cable (405210) to the Spot LXi.
2. Connect the small end of the cable (405210) to the Spot LXi printer.

Connect to Spot
LXi

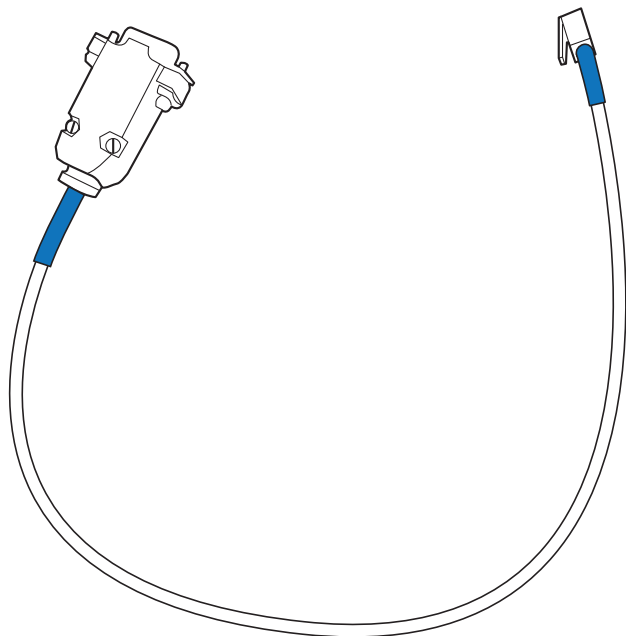

Connect to Spot
LXi printer

To charge the Spot LXi printer:

1. Remove the guard on the power supply body (713703 or BC1300M) and attach the appropriate power supply plug/adaptor.

2. Connect the Spot LXi printer power supply to the Spot LXi printer.
3. Charge the Spot LXi printer for at least 9 hours before initial use.

To enable the Spot LXi printer:

1. Connect the Spot LXi printer to the Spot LXi.
2. Enable the printer in the Internal Configuration Mode of the Spot LXi (see [“Internal Configuration Mode”](#) on page 32).

Battery

Charge the Spot LXi battery and printer battery (if using) for 9 hours before initial use. Charge the device an additional hour if it includes a Braun ThermoScan PRO 4000 thermometer.

Note While charging the Spot LXi, it is acceptable to charge the Spot LXi printer with the power supply (713703 or BC1300M).

While Spot Vital Signs LXi is charging, the charging LED (~) flashes and the battery level indicator segments on the display continuously sequence. When the battery is fully charged, the charging LED stops flashing and the battery level indicator will stop sequencing.

If the device includes a Braun ThermoScan PRO 4000 thermometer, the charging LED below the thermometer will illuminate orange as it is charging. When the battery is fully charged, the LED will power off.

If the Spot LXi has a mounted, external printer that is connected via the cable, the charging LED on the printer flashes orange and green when the Spot LXi is plugged into the AC main power source. If the Spot LXi has a mounted, external printer that is not connected via the cable, the charging LED on the printer will not flash.

Note There is no hazard associated with leaving the battery in the device, even if the device is not used for long periods of time.

3

Functional Overview

This functional verification procedure helps to confirm the proper operation of the Spot Vital Signs LXi and options. This procedure supports the requirements of routine preventative maintenance. It is not necessary to disassemble the Spot Vital Signs LXi to perform this procedure.

For the calibration procedures, see [“Calibration and Verification”](#) on page 49. If the Spot Vital Signs LXi fails certain functional tests or a circuit board is replaced, the device may require calibration. Always perform this functional verification procedure after performing any calibration.

Self Test

The Spot Vital Signs LXi performs a self-test each time the device is powered on. Press the **Power** button to turn the device on or off. Upon each power up, the display turns on, two audible beeps occur, and the Spot Vital Signs LXi displays the model and serial numbers. If the internal self-check is successful, the display shows its normal functions (see [Figure 4](#) on page 23) with all values blank, and the device is ready for operation. If the self-check fails, an error code is shown in the Navigation Window (see [“Error Codes”](#) on page 99).

Spot Vital Signs LXi automatically powers off when not used for 30 minutes.

Internal Configuration Mode

You can change several device operating parameters in the Internal Configuration Mode. When changed, these settings become the default power-up settings. You will also see non-changeable device configurations for technical service purposes.

To Enter the Internal Configuration Mode:

1. Turn the Spot Vital Signs LXi off.
2. Press and hold the **Select** and **Power** buttons for 5 seconds. The device enters the Internal Configuration Mode and the Configuration Menu screen appears on the display.

Figure 7. Internal Configuration Mode Menu

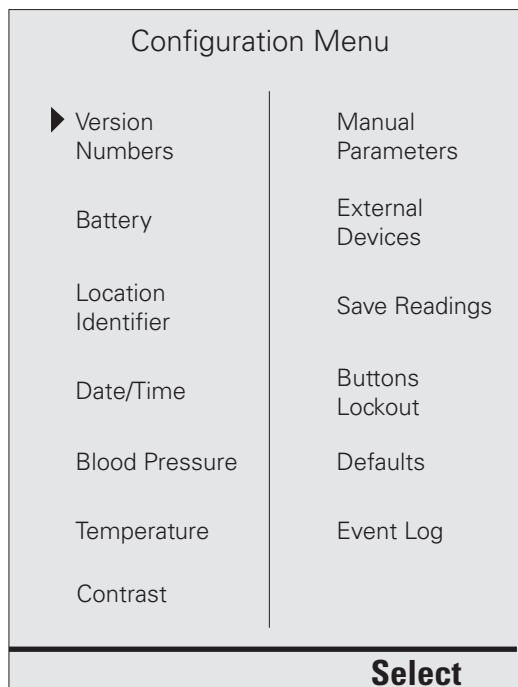

3. Use the **Navigation** buttons to move through the menu options and then press the **Select** button to access the options or accept a change. See the following tables for descriptions of the menu options.
4. Press the **Power** button to exit the Internal Configuration Mode.

Table 2. Configuration Menu Options

Setting	Description
Version Numbers*	Displays the software and hardware version numbers in the Spot Vital Signs LXi device.
Battery*	Displays the battery level.
Location Identifier	Allows the entry of the device's location (e.g., the department name). Follow the display prompts and use the Navigation and Select buttons to enter up to 10 characters.
Date/Time	Changes the date and time formats or updates the actual date and time. See Table 3, "Date/Time Menu Options" for available settings.
Blood Pressure	Changes the blood pressure options. See Table 4, "Blood Pressure Menu Options" for available settings.
Temperature	Changes the temperature options. See Table 5, "Temperature Menu Options" for available settings.
Contrast	Changes the Display Contrast options. Use the left/right navigation buttons to adjust.
Manual Parameters	Changes the manual parameters defaults. See Table 6, "Manual Parameters Menu Options" for available settings.
External Devices	Enables or disables available external devices. See Table 7, "External Devices Menu Options" for available settings.
Save Readings	Saves the current patient reading at a preselected time interval or upon request. See Table 8, "Save Readings Menu Options" for available settings.
Buttons Lockout	Secures Spot Vital Signs LXi so unauthorized people cannot use the device or access data without enacting the proper key sequence. To override the buttons lockout feature, simultaneously press the Left Navigation button and the Select button.
Defaults	Allows the user to select the default settings for the device and reset the unit to the default settings. See Table 9, "Change Local Defaults Options" for available settings.
Event Log*	Displays the recent button presses, errors, measurements, measurement sites, battery state changes, and patient reading send events.

* Displayed information only; operator cannot change.

Table 3. Date/Time Menu Options

Setting	Description
Date Format	Displays the date in one of the following styles: <ul style="list-style-type: none"> mm/dd/yyyy example: July 16, 2005 = 07/16/2005 dd/mm/yyyy example: 16 July 2005 = 16/07/2005
Date	Changes the date on the Display Window and in patient readings. If a location is entered (see " Location Identifier " in Table 2, "Configuration Menu Options"), the date will not appear on the Display Window; the location will.
Time Format	Displays the time in one of the following styles: <ul style="list-style-type: none"> 12-hour example: 5:00 PM 24-hour example: 17:00
Time	Changes the time on the Display Window.

Table 4. Blood Pressure Menu Options

Setting	Description
BP Calibration Check	Prepares the Spot Vital Signs LXi for calibration. Only qualified personnel should verify the Spot Vital Signs LXi blood pressure calibration. For more details, see "Blood pressure calibration" on page 62.
Blood Pressure Units	mmHg or kPa.
Mean Arterial Pressure (MAP)	On or off.

Table 5. Temperature Menu Options

Setting	Description
Temperature Units	Fahrenheit (°F) or Celsius (°C).
Temperature Mode	SureTemp Plus models only: Oral, Pediatric Axillary, Adult Axillary, and Last Mode. In Last Mode the device takes the next temperature in the mode in which the previous temperature was measured. Rectal Mode is available only when the rectal probe (red ejection button) and probe well are attached.

Table 6. Manual Parameters Menu Options

Setting	Description
Height	On or off.
Height Units	Inches (in) or centimeters (cm).
Height Default	Changes the default patient height displayed in the Navigation Window.
Weight	On or off. Even if weight is enabled here, if weight scale is enabled in the External Devices Menu, you cannot manually enter the weight.
Weight Units	Pounds (lb) or kilograms (kg).
Weight Default	Changes the default patient weight displayed in the Navigation Window.
Respiration	On or off.
Pain Level	On or off.

Table 7. External Devices Menu Options

Setting	Description
Information System	On or off. You must enable this option to send patient readings wired or wirelessly.
Barcode Patient ID	On or off. You must enable this option to send patient readings wirelessly.
Barcode Clinician ID	On or off. You must enable this option to require mandatory sign in of a clinician.
Mandatory Sign In	Yes or no. You must enable this option to require the sign-in of the clinician.
Clear on Send/Save:	Yes or no. You must enable this option to clear the Clinician ID after sending or saving the measurements.
Clear on Power Cycle:	Yes or No. You must enable this option to clear the Clinician ID after powering the Spot Vital Signs LXi off.
Weight Scale	On or off. Spot Vital Signs LXi connects to a scale and the weight shows on the display window (see "Spot Vital Signs LXi Technical Overview" on page 37 for scale details).
Wireless Module	None or DPAC. You must enable 802.11 B to send patient readings wirelessly. The radio is available as an accessory only with Welch Allyn Connex.
Printer	On or off.
Printer Paper	Plain or labels. Only available if the Printer is enabled.

Table 8. Save Readings Menu Options

Setting	Description
Save Mode	Manual or automatic. If automatic, Spot Vital Signs LXi saves readings at a preselected time interval. For either option, Spot Vital Signs LXi automatically saves the measured parameters into memory before automatically powering off when not used for 30 minutes.
Auto Save Interval	Changes the amount of time before automatically saving the current patient reading. Only available if Automatic Save Mode is enabled.
Reading Full Action	Auto Overwrite, Ask Overwrite, Do not Overwrite. Spot Vital Signs LXi can save 50 patient readings in memory. Upon reaching reading 51, the device may automatically overwrite reading 1, ask the user if he/she wants to overwrite reading 1, or disable the ability to take another reading until at least one reading is erased.

Table 9. Change Local Defaults Options

Setting	Description
Language	English, Dansk, Nederlands, Suomi, Français, Deutsch, Italiano, Norsk, Español, Português, Svenska, or Chinese.
BP Units	mmHg or kPa.
Temperature Units	Fahrenheit (°F) or Celsius (°C).
Height Units	Inches (in) or centimeters (cm).
Weight Units	Pounds (lb) or kilograms (kg).
Date Format	Displays the date in one of the following styles: <ul style="list-style-type: none"> • mm/dd/yyyy example: July 16, 2005 = 07/16/2005 • dd/mm/yyyy example: 16 July 2005 = 16/07/2005
Time Format	Displays the time in one of the following styles: <ul style="list-style-type: none"> • 12-hour example: 5:00 PM • 24-hour example: 17:00

4

Spot Vital Signs LXi Technical Overview

System Description

The Spot Vital Signs LXi automatically measures systolic and diastolic pressure (excluding neonates), pulse rate, temperature (oral, adult axillary, pediatric axillary, rectal, and ear), and pulse oximetry (SpO₂) as well as calculates Mean Arterial Pressure (MAP). Furthermore, Spot Vital Signs LXi allows the entry of height, weight, respiration rate, and pain level. Spot Vital Signs LXi also calculates Body Mass Index (BMI) following height and weight entry.

The device is intended to be used by clinicians and medically qualified personnel. It is available for sale only upon the order of a physician or licensed health care provider.

Refer to the Spot Vital Signs LXi Directions for Use manual for complete information.

Battery System

Spot Vital Signs LXi uses a fuse and a shunt diode on the main board as well as a fuse in the battery assembly for protection against reverse battery connections. The fuse is located on the main board in the negative battery line. In the event of a reverse battery connection, a blown fuse will require replacement. The negative line location is more likely to short the battery (+) wire to ground than short the battery (-) wire to the VBUS node.

Battery Charger

Provides two levels of power to fast-charge or to float the battery at fixed voltages using software control. The fast-charge level rapidly brings the battery up to near-full capacity (7 Volts) using software to not overcharge the battery. The float level, set per the manufacturer's recommendation, slowly tops-off the battery and can stay on indefinitely.

"CPU I/O" Power Supply

Provides power to the I/O pins of the DragonBall MPU and the attached peripheral IC's. The nominal voltage is set to a value of 3.15 Volts so that both the 3.0 Volt MPU and 3.3 Volts peripherals can operate within specifications. Spot Vital Signs LXi uses buck switching topology for efficiency and an on-off power latch directly controls the power supply.

Standby Mode

The Standby Mode conserves battery power. The device goes into Standby Mode if it is not used for two minutes. Press any button to bring the Spot Vital Signs LXi out of Standby Mode.

CPU Core Power Supply

Powers the MPU core only and operates at the recommended Dragonball voltage range of 1.8 +/- 0.1 Volts; 2.0 Volts absolute max.

The +3.15 Volt supply powers the +1.8 Volt supply for efficiency and, more importantly, for power sequencing. During power-on the +1.8 Volt supply cannot exceed the +3.15 Volt supply. The R207/C182 further delays the +1.8 Volt supply. During power-off, D106 prevents the +1.8 Volt supply from exceeding the +3.15 Volt supply by more than a partial diode drop.

+5V Supply

Provides supply to miscellaneous loads that require more than 3.15 Volts. The Power Latch controls the supply and the average load current is small, so efficiency is not important.

Clock/Calendar Power

The Clock/Calendar U19 receives power from two sources. During power on the clock runs from the +5 Volt supply and during power down the clock receives power directly from the battery potential using a voltage divider. Capacitor C131 provides power to the U19 during the battery exchanges. Zener D102 prevents overvoltage to U19 in the case of operation directly from the charger.

Mod F NIBP Power

This module is powered directly from VBUS through an EMI filter. Software via BP-PWR-ON-BAR controls the power. Level shifter Q115 / Q104 assures that the module remains off when the MPU is unpowered.

SpO₂ and Thermometer Power

A common structure supplies SpO₂ and thermometry. A single push-pull driver delivers square wave power to a pair of isolation transformers, one for SpO₂ and the other for thermometry. THERM-PWR-BAR activates the driver under software control. Level shifter Q118, Q119 assures that the module remains off when the MPU is unpowered.

In the push-pull (forward) configuration, VBUS is multiplied by the transformer turns ratio and supplied to the input of the rectifier diodes. This is filtered and passed through low-noise 5-Volt linear regulators to supply power to the parameter modules.

LCD Power

The LCD data interface connects directly to the +3.15 Volt MPU I/O power supply. This powers the driver ICs inside the LCD pane and assures the data interface to the LCD is always powered when the unit is powered.

The contrast (bias) supply to the LCD panel and the LCD CCFL backlight both derive power indirectly from a pre-regulator. A software control can shut down the pre-regulator. For efficiency, it is implemented as a buck switcher operating directly from the battery. The primary purpose of the pre-regulator is to protect the backlight inverter / ballast from battery voltages that it cannot tolerate and to control current out of the unregulated ballast. The voltage is set to the low side of 5 Volts to reduce battery consumption, while still driving the CCFL with adequate voltage.

External Load (RS-232) Power

There are two power outlet means on the Spot Vital Signs LXi – RS-232 port power and the Braun PRO 4000 charger.

Two isolated power supplies provide power to each of the external RS-232 ports. This power is available to external devices on pin 9 of each serial connector whenever the software enables the corresponding RS-232 port.

SureTemp Plus Thermometer Interface

The SureTemp Plus OEM module is located in an optional pod and is connected to the main PCB via a flex cable. The Thermometer Probe connection is located on a separate PC board. It is connected to the SureTemp Plus OEM module by a ribbon cable. The electrical interface to the thermometer pod is a 6-pin ribbon connector, Molex 52271-0690 or equivalent.

Braun ThermoScan PRO 4000 Thermometer Interface

The interface to the Braun ThermoScan PRO 4000 thermometer is located in the optional pod and connects to the main PCB via a flex cable. The communications link is a single duplex current loop that also charges the Braun battery pack.

The presence or absence of current passing through the Braun ThermoScan PRO 4000 charge contacts controls the interface charge LED, located within the pod, which mimics the Braun ThermoScan Pro 4000 Base Station (type 6021).

SpO₂ Description

A shielded flat-flex cable connects the user interface sensor connector J8 to the SpO₂ electronics.

The Masimo SpO₂ module mates to the Masimo Adaptor Board that, in turn, mates to the Main board. This provides power and communications to the module from the Main board.

The Nellcor SpO₂ module mounts directly to the Main board. This provides power and communications to the module, and brings the sensor signals to the main board where EMI and ESD can be controlled. The sensor signals pass through the main board to the mating connector for the shielded flat-flex cable.

Radio Description

For the wireless radio description, refer to the manufacturer's Directions for Use.

The radio interfaces to the Spot Vital signs LXi through an RS-232 female connector with a 9-pin male/female null modem connection.

Figure 8. 9-pin Null Modem Pinout

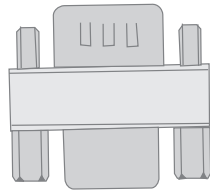

MA 0051 (DB9M/F) Adapter Pin out:

09 Male	09 Female
2	3
3	2
4	1 + 6
5	5
1 + 6	4
7	8
8	7
9	9
G	G

Bar Code Scanner Description

The Spot Vital Signs LXi has a 2D scanner (IMAGETEAM™ 4600). This scanner is programmed specifically for Welch Allyn. Scanners not purchased through Welch Allyn will not work with the Spot Vital Signs LXi.

Interface

The bar code scanner interfaces to Spot Vital Signs LXi through an isolated RS-232 DB-9 female connector. Use Welch Allyn part number 4500-910 for the barcode option.

Printer Description

The SPOT Vital Signs LXi interfaces with printer kit 4500-500.

Table 10. LED Pattern Table

Pattern	Battery	Buffer Mode
Constant Green	Running	Normal
Fast Flashing Green	Running	Spool *
Long Green - Short Red	Battery Low	Normal
Short Green - Short Red	Battery Low	Spool *
Short Green - Long Orange	Trickle Charging	Normal
Long Orange Flash	Trickle Charging	Spool *
Fast Flashing Orange	Fast charging	Spool (Printing prohibited)
Fast Flashing Red	Error Condition	Spool (Printing prohibited)
No Light	Flat or in sleep mode	

* Spool may have resulted from Paper Out or Head Up conditions)

No hardware power switch is fitted, as power control is either automatic or by command from the host computer. To save power, the printer enters sleep mode after a period of inactivity, factory-set to 30 seconds.

The printer external power supply is used to charge the printer batteries.

Interconnect Diagram

(For drawing details see “Interconnect Diagram 1” on page 147 and see “Interconnect Diagram 2” on page 148.

Item	Description	Item	Description
A1	PCA, Main, Spot Vital Signs LXi	W1	Assy, Power Harness, Spot Vital Signs LXi
A1-F1	Fuse, FlastBlo, 5A	W1-A1	PCA, Power Interface, Spot Vital Signs LXi
A2	PCA, Serial Interface, Spot Vital Signs LXi	W2	Flex, Main, Spot Vital Signs LXi
A3	Display, LCD, 320 x 240, Mono	W3	Cbl Flx, 1/2mm, 15 POS
A4	Inverter, LCD	W4	Assy, Ballast Harness, Spot Vital Signs LXi
A5	Assy, Battery, Spot Vital Signs LXi	W5	Assy, LCD Gnd Harness
A5-F1	Wire Protection Fuse	W6	Assy, Cable, Flat Flex, SpO ₂ Wire Clip, Side Entry,.375 Wide
A6	Assy, Fan Unit Cooling		Foam Strip, 2 Sided Adhesive
A7	PCA, Masimo Adapter, Spot Vital Signs LXi	W7	Cbl, Flx, 1mm, 6POS
A8	Masimo MS-11 SpO ₂ Shield, Masimo EMI Tape, Copper, Masimo Shield	W8	Cbl, Flx, 1mm, 8POS
A9	PCA, SureTemp Plus, OEM w/o EDAC	W9	Cbl, Flx, Braun, Spot Vital Signs LXi
A10	PCBA, BP OEM, (MOD F)		
A11	Assy, Pump, and Tubing, Spot Vital Signs LXi		
A11-F1	Filter, Air, 1/8 Barbs		
A12	Assy, Transducer Tubing, Spot Vital Signs LXi		
A13	PCA, EDAC, Spot Vital Signs LXi		
A14	Nellcor MP506 SpO ₂ PCB		
A15	PCA, Braun Interface, Spot Vital Signs LXi		

Wire Color

BLK	Black
BRN	Brown
RED	Red
ORN	Orange
GRN	Green
BLU	Blue
PNK	Pink

5

Maintenance and Service

Cleaning



WARNING Before performing any maintenance or service to the Spot Vital Signs LXi, disconnect the AC power line from the electrical outlet.

Spot Vital Signs LXi



Caution Prevent water or other fluids from entering any connectors. If the connectors get wet, dry them with warm air. Check all measurement functions.

Caution Do not sterilize or autoclave the Spot Vital Signs LXi device.

As necessary, clean the device with a cloth slightly dampened with either 70% isopropyl alcohol, 10% chlorine bleach solution, or mild detergent in water, or use PDI Sani-System Cloths. Never immerse Spot Vital Signs LXi in any type of fluid.

Blood Pressure Cuff

Before washing the Reusable Two-Piece Cuff, remove the two connectors and bladder, close off tubes with plugs (available as accessory 5082-163), and close the hook and loop fasteners. After washing, allow the cuff to air dry. Re-assemble the tube fittings.

Never press with an iron.

Blood Pressure Hose and Cable

Wipe the pressure hose with a damp cloth moistened in a mild detergent solution. Do not immerse hose.

SureTemp Plus Thermometer

Temperature Probe



Caution DO NOT immerse or soak the probe in any type of fluid.

Caution DO NOT use steam, heat, or gas sterilization on the probe.

Caution DO NOT autoclave the probe.

Press down on the connector tab and slide the connector out of the port to remove the temperature probe.

Regularly wipe the probe with a cloth dampened with warm water and a mild detergent solution, a 70% isopropyl alcohol solution, or a 10% chlorine bleach solution.

Removable Probe Well



Caution DO NOT use hard or sharp objects to clean the probe well. This could damage the probe well and cause the device to not function properly.

Caution DO NOT use steam, heat, or gas sterilization on the probe well.

Caution DO NOT autoclave the probe well.

1. Remove the temperature probe from Spot Vital Signs LXi (see “Temperature Probe” on page 44).
2. Grasp the well under the probe opening and pull up gently to remove it from the device.
3. Swab the inner and outer surface of the probe well with a cloth dampened with a mild detergent solution, 70% isopropyl alcohol, or 10% chlorine bleach solution. Immerse the probe well in mild detergent solution as necessary for cleaning.
4. Dry all surfaces thoroughly before re-assembling the device (see “SureTemp Plus” on page 26) for reassembly instructions.

Braun ThermoScan PRO 4000 Thermometer

Use a soft cloth slightly moistened with alcohol to clean the thermometer display and exterior. Do not use abrasive cleaners.

Damage to the probe tip or the presence of dirt or cerumen on the probe tip can affect the accuracy of your temperature measurement. To clean the tip, gently wipe it with a cotton swab slightly moistened with alcohol and immediately wipe dry with a clean cotton swab. Allow to dry at least five minutes before taking a temperature.

Every month, clean the Braun ThermoScan PRO 4000 charging contacts within the Spot Vital Signs LXi housing with a swab slightly dampened with alcohol.

SpO₂ Sensors



WARNING Do not immerse the sensor in water, solvents, or cleaning solutions (the sensors and connections are not waterproof). Do not use irradiation, steam, or ethylene oxide for sterilization.

Clean the reusable SpO₂ sensor with a 70% isopropyl alcohol solution. Do not immerse the sensor.

Radio

Refer to Manufacturer's Directions for Use.

Printer

The printer label kit comes with a two-step head cleaner. Follow the directions provided with the cleaner.

Battery Replacement

Spot Vital Signs LXi



Caution Only use the Welch Allyn 4500-84 lead acid battery. Using an incorrect battery will cause damage to the Spot Vital Signs LXi and void the warranty.

Caution Do not break the shrink-wrap around the battery.

If necessary, replace the internal battery after heavy use or the battery no longer charges.

1. Power off the Spot Vital Signs LXi and disconnect the AC power transformer cord.
2. Remove the four screws holding the battery door using a phillips-head screwdriver. Remove the battery door to expose the battery.
3. Tip the Spot Vital Signs LXi backward and slide the battery out. Disconnect the one-way connector and then attach a new battery to the connector as shown. The one-way connector ends only connect one way. Do this as quickly as possible to prevent loss of clock time.

Figure 9. Battery Removal and One-way Connector

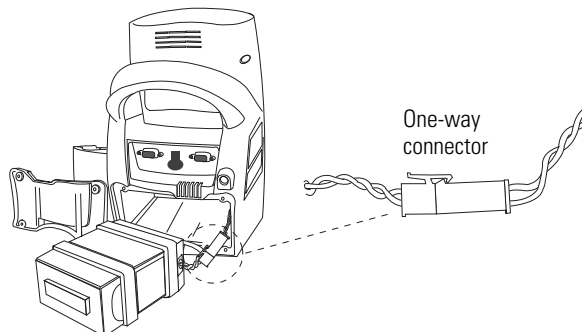

4. Slide the battery into the compartment as far as it will go. Push the connector down into the case next to the battery.
5. Replace the battery door and tighten each of the four screws.
6. Connect the AC power transformer to the Spot Vital Signs LXi and allow the new battery to charge for approximately 9 hours. The rechargeable batteries in the Braun ThermoScan PRO 4000 thermometer require an additional 1 hour to charge. You can use the Spot Vital Signs LXi during this charging period via the AC power cord.

If Spot Vital Signs LXi displays the E38 error code after power up, set the date (see "Date/Time Menu Options" on page 33).



The battery is a non-spillable lead-acid battery and must be recycled or disposed of properly according to national or local regulations.

Braun ThermoScan PRO 4000



Caution Do not use alkaline batteries in the Braun ThermoScan PRO 4000 thermometer.

Welch Allyn supplies a rechargeable battery pack with the Braun ThermoScan PRO 4000 thermometer.

1. Open the battery compartment.
2. Remove the battery pack and replace with a new battery pack, verify the poles are in the right direction.
3. Slide the battery door back in until it snaps into place.

If the battery is completely discharged, the LEDs will not illuminate. Allow the unit to charge at least 15 minutes before proceeding.



The battery is a rechargeable battery and must be recycled or disposed of properly according to national or local regulations.

Printer



Caution Do not use alkaline batteries in the printer.

1. Open the battery compartment.
2. Remove the battery pack and replace with a new battery pack, verify the poles are in the right direction.
3. Slide the battery door back in until it snaps into place.

Allow the printer to charge at least 9 hours before proceeding.



The battery is a rechargeable battery and must be recycled or disposed of properly according to national or local regulations.

Spot Vital Signs LXi Firmware Upgrade CD

This CD upgrades the Spot Vital Signs LXi unit software version. A detailed procedure is available on the upgrade CD.

Spot Vital Signs LXi Radio Configuration CD

The software on this CD configures the Spot Vital Signs LXi Radio for use on a local wireless network.

Product Disposal

Do not dispose of this product as unsorted municipal waste. Prepare this product for reuse or separate collection as specified by Directive 2002/96/EC of the European Parliament and the Council of the European Union on Waste Electronic and Electrical Equipment (WEEE). If this product is contaminated, this directive does not apply.

For more specific disposal information, see www.welchallyn.com/weee, or contact Welch Allyn Customer Service at +44 207 365 6780.

6

Calibration and Verification

Terms

BP test volume repair fixture. Equipment with four separate 100cc, 250cc, and two 500cc linearity volume cylinders. Referred to in this procedure as “Test Volume”.

Calibration. Process to change the outputs of the UUT that are out of range. After saving, the changes become permanent until the next calibration.

Pneumatic test assembly. Equipment that connects the UUT, the pressure meter, the squeeze bulb, and the BP test volume repair fixture.

Spot LXi Service Tool. Software package to verify and calibrate the Spot LXi device.

Service computer. Computer with the repair software loaded and ready to operate.

Functional Tests. Process to check the outputs of the UUT.

UUT. Unit under test.

Required Test Equipment

Description	Part Number	Qty
Power supply, 0-10 Volts, 2 amps capacity or better, fine voltage adjustment required		
Digital multi meters (DMM)		2
Battery simulator connector, 24 inch or shorter		
Patch cords- banana plug to banana plug, Red, 18 AWG, 24 inch or shorter		3
Patch cords- banana plug to banana plug, Black, 18 AWG, 24 inch or shorter		2
USB Cable, 2.0/5-Pin Mini-B Cable		
Calibrated pressure meter		
PC running Spot Lxi Service Tool (Ver 3.0 or greater)	4500-905	
9600 Plus Temperature Calibration Tester	01802-110	
Nellcor-approved SpO2 simulator, <i>for devices with Nellcor option</i>	SRC-MAX	
Masimo SpO2 Tester, <i>for devices with Masimo option</i>	1795	
Thermometer Calibration Key, Optional	06138-000	
Blood pressure two-tube hose with Y fitting	5082-183	
Blood pressure two-tube hose (standard cuff)	4500-30	
BP test volume repair fixture (includes items below) Note This is the new Test Volume needed for passing the NIBP Linearity Test	407672	
BP test volume repair fixture. Must have at least the following volume cylinders: 100cc, 250cc, and 500cc		
Squeeze bulb with bleeding screw		
Square (4-way) tube fitting connector		
12-inch (30.5 cm) tubing with .25-inch (6.35 mm) ID		4

Pneumatic test assembly setup

1. Connect the squeeze bulb with bleed screw to a square (4-way) tube fitting connector, a calibrated pressure meter, a test volume, and to a blood pressure two-tube, Y-fitting hose as shown in [Figure 1](#) on page 51.

Figure 1. Pneumatic test assembly setup

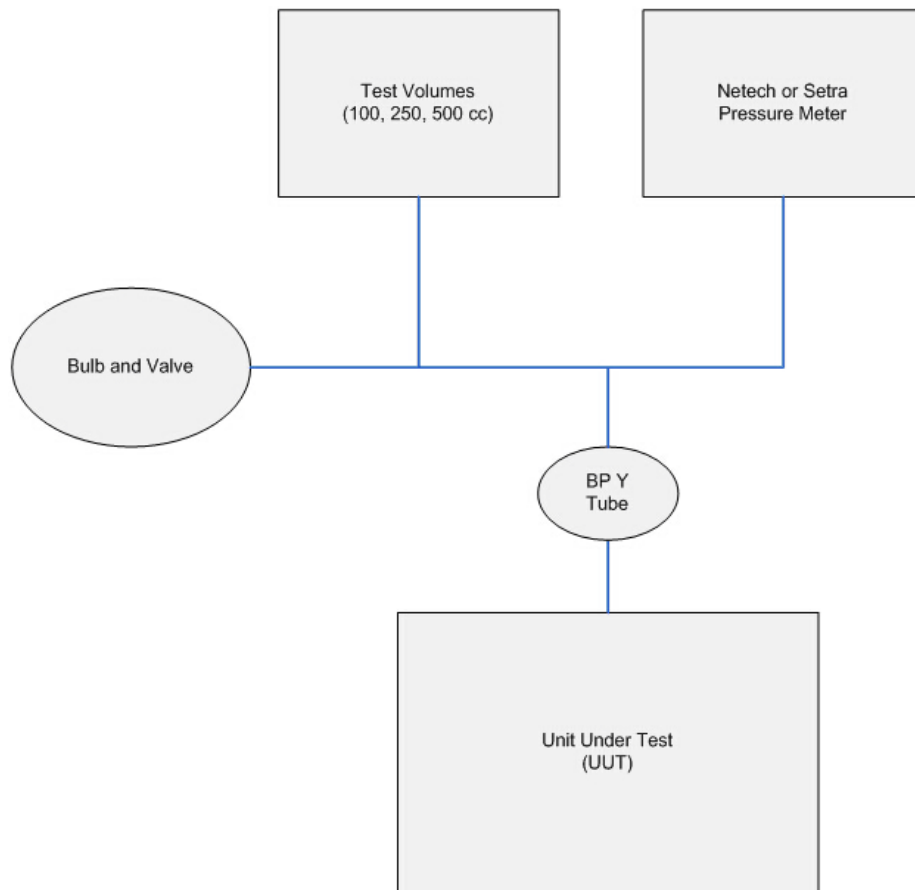
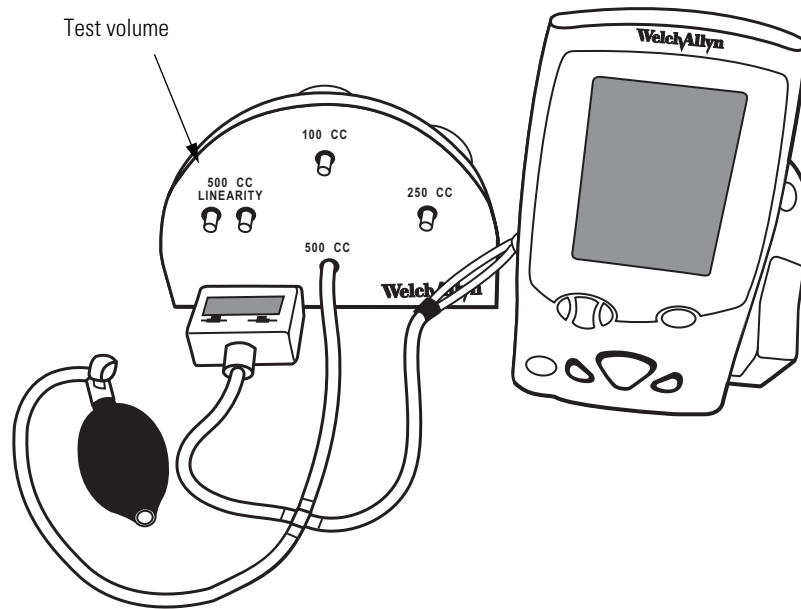

Power Supply Test Setup

1. Connect the power supply to the Battery Simulator connector, banana plug patch cords, digital multi meter (DMM) for voltage monitoring, DMM for current monitoring.

Figure 2. Power Supply Test Setup

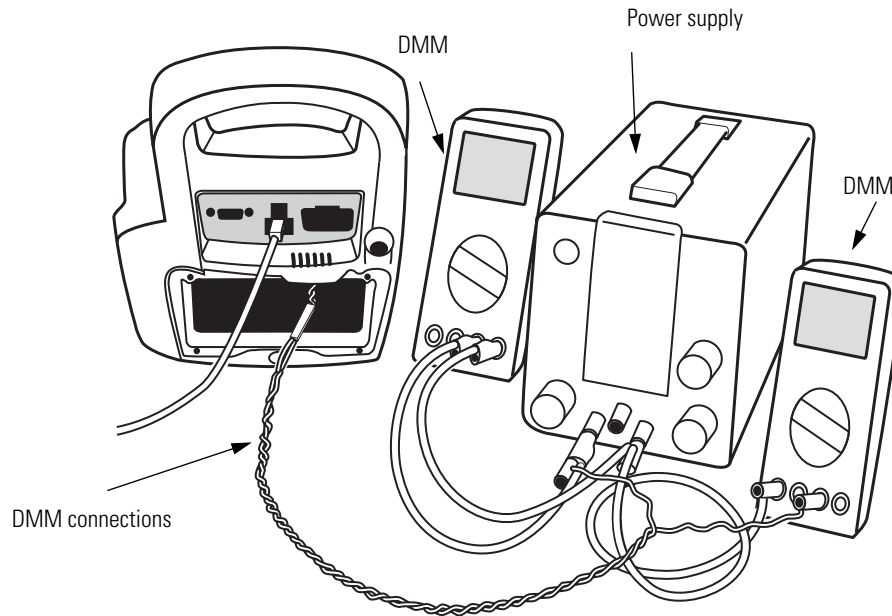

Test the power supply output as shown in [Figure 3](#). Observe the correct polarity.

Figure 3. Power Supply

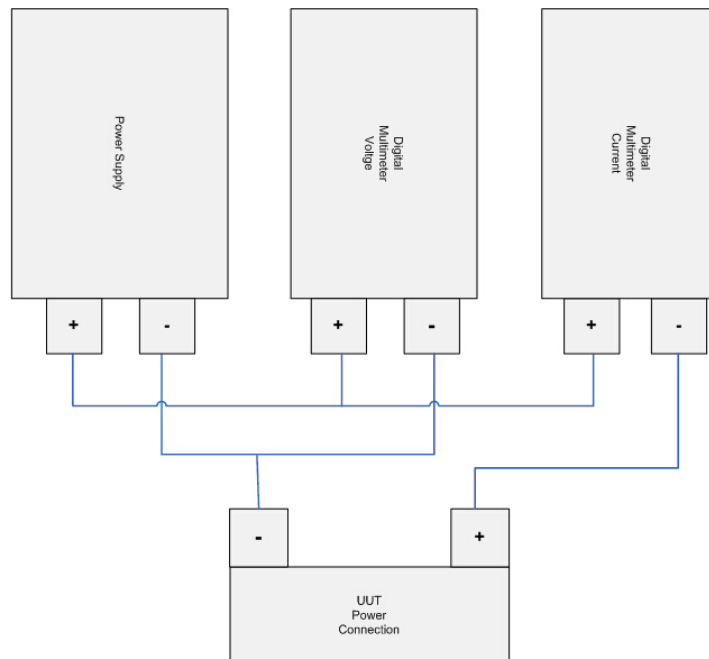

2. Turn on the power supply and adjust to 6.5 +/- 0.1V DC before connecting the UUT. Turn off power supply.
3. Disconnect the UUT battery and connect the external power supply to the UUT, using the Battery Simulator. Observe the correct polarity.



Caution DO NOT connect the Spot LXi AC power adapter to the UUT power connection port. This will result in damage to the UUT, AC power adapter, or the Battery Simulator power supply.

4. Turn on the Power Supply.

Note All tests and verification in this procedure require battery voltage input adjusted to 6.5V DC; Except as called out in the Voltage Calibration section.

Battery Removal / Power Shutdown

Removal of the UUT battery, or power shutdown of the Battery Simulator external power supply, will require reset of the date and time prior to any further testing, calibration, or verification activities.

Time & Date Reset:

1. Power on the UUT in configuration mode by pressing the **Check** and **Power On** buttons on the UUT. Hold the **Check** button until the UUT beeps twice. The UUT screen displays any POST errors detected.

Figure 4. POST Errors Detected

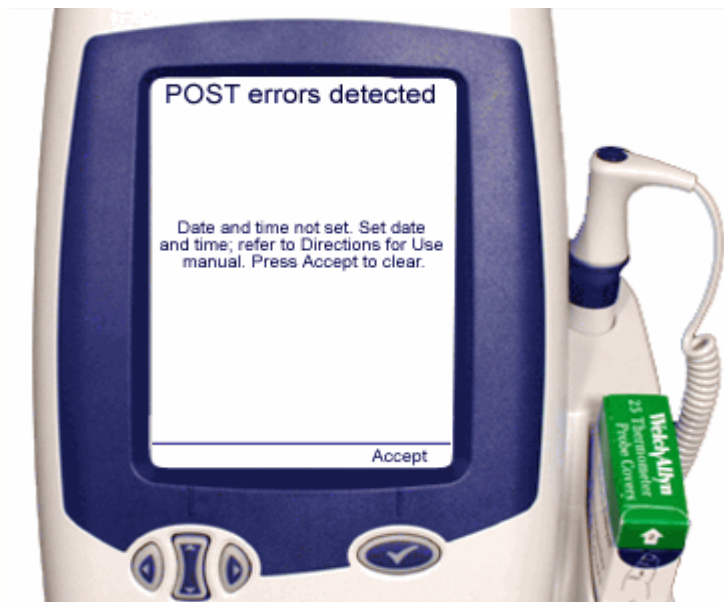

2. Click the **Check** button on the UUT. The Configuration Menu opens.
3. Scroll to **Date/Time** on the UUT Configuration Menu and select.

Figure 5. Date/Time Menu

4. Scroll to **Date** on the UUT and select. Using the navigation keys, adjust the correct date and select. Scroll to **Time** and select. Using navigation keys, adjust the correct time and select.

Figure 6. Set Date, Set Time

5. Scroll to **Exit** and select.

Figure 7. Exit Menu

6. Reset the UUT using the power button. Do NOT turn off the power supply. The next power up of the UUT screen displays the correct date and time without errors.

Voltage Calibration

1. Remove the battery from the UUT. Connect the UUT to a Battery Simulator with the external power supply set to 6.5 +/- 0.1V DC. (Follow the steps in "[Power Supply Test Setup](#)" on page 52.)
2. Connect the service PC running the Spot Lxi Service Tool to the UUT with the USB Cable. Open the Spot LXi Service tool from the PC.
3. Power on the UUT in configuration mode by pressing the **Check** and **Power On** buttons on the UUT. Hold the **Check** button until the UUT beeps twice.

Figure 8. Configuration Menu

4. Verify the power supply is at $6.5 \pm 0.1V$ DC at the battery connector simulator leads.
5. Verify that the UUT is connected and communicating with Spot Lxi Service Tool.
Select Unit > Information. The Unit information window opens. Click **OK** to close.
6. Select **Calibrate > Voltage** on the service computer. The UUT screen goes blank.

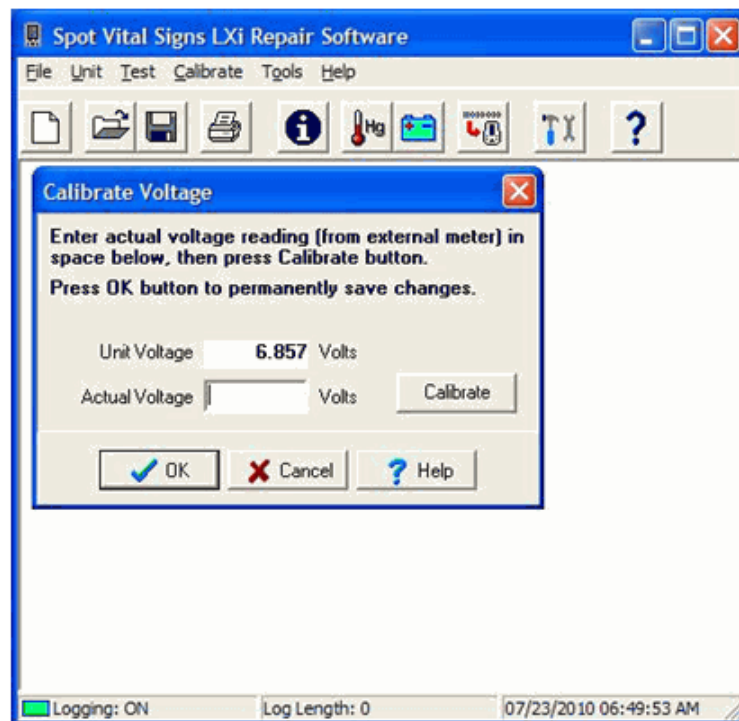
Figure 9. Calibrate Voltage

7. Carefully adjust the power supply to $5.5 \pm 0.1V$ DC at the battery connector simulator leads. A fine voltage adjustment will be needed to make this adjustment.

Note Do not adjust power supply below 5.5V DC or the UUT will go into shutdown mode.

8. Read the voltage on the DMM that is connected to the battery simulator leads.
9. Enter this voltage reading into the **Actual Voltage** field and click the **Calibration** button.
10. Click the **OK** button to accept the inputs. Click **Yes** to make the changes permanent.
11. Enter your initials in the Calibration Signature field and click **OK**. The UUT resets and powers up in normal mode.

Figure 10. Calibration Signature Field

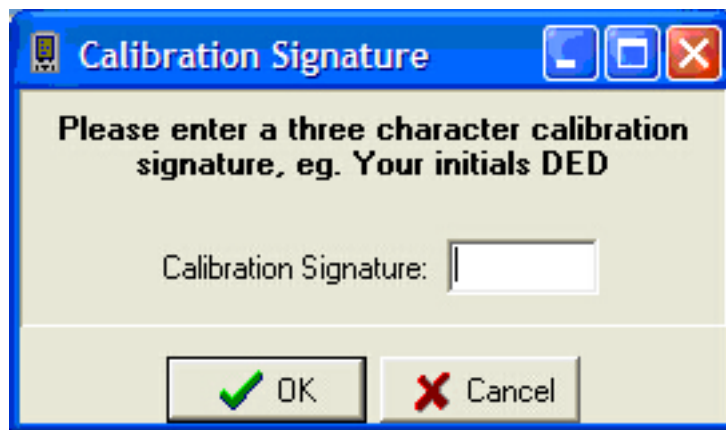

Note After "Reset" and power up, the UUT detects the low 5.5V DC supply setting and goes into auto shutdown. Adjust power back to 6.5V DC.

Pressure verification test

Spot LXi devices require annual calibration.

Note If this is a new NIBP board, go to "[NIBP board Initialization](#)" on page 62 and carefully follow the instructions to initialize this board.

1. Connect the UUT to the pneumatic test assembly using the two-tube blood pressure hose with the Y-fitting.

Figure 11. Blood Pressure Hose with Y-fitting

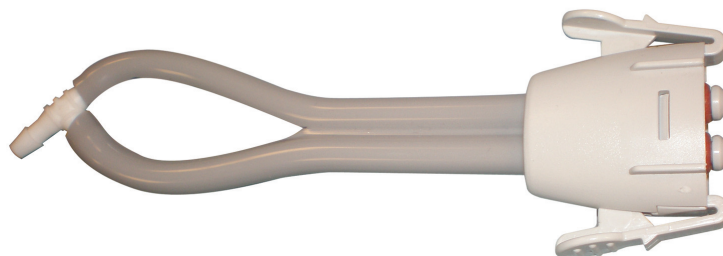

2. Connect the test volume hose to the 500cc cylinder.

3. Power on the UUT in configuration mode by pressing the **Check** and **Power On** buttons on the UUT. Hold the **Check** button until the UUT beeps twice. The configuration screen displays.

Figure 12. Configuration Menu



Scroll to Blood Pressure and select it

Figure 13. Blood Pressure Menu

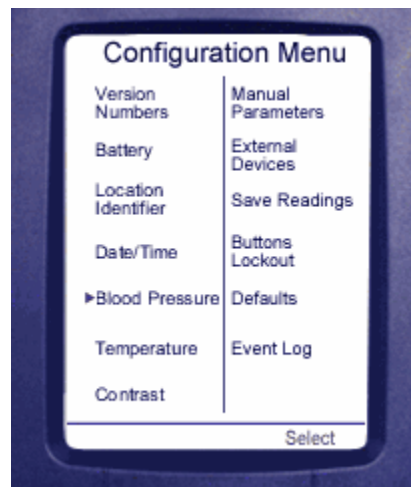

Select **BP Calibration Check**.

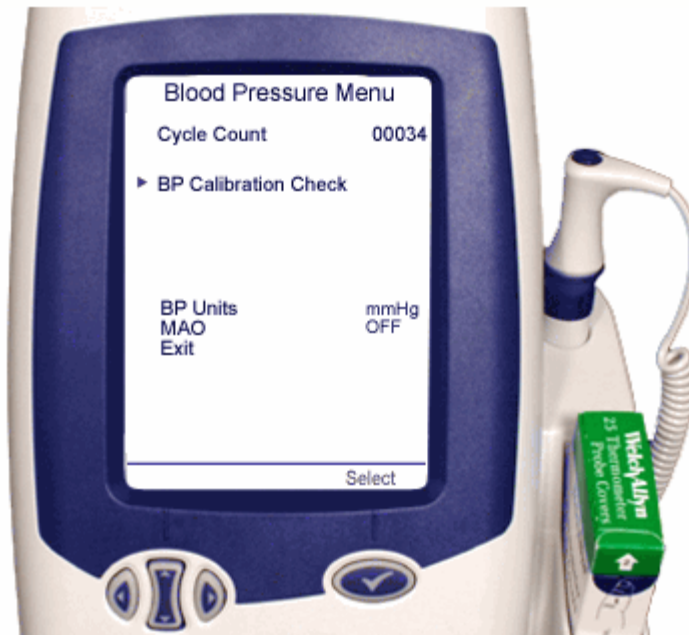
Figure 14. BP Calibration Check

4. Open the Spot LXi Service Tool on the service computer and select **Test > Calibration**. A Test Calibration box displays on the screen.

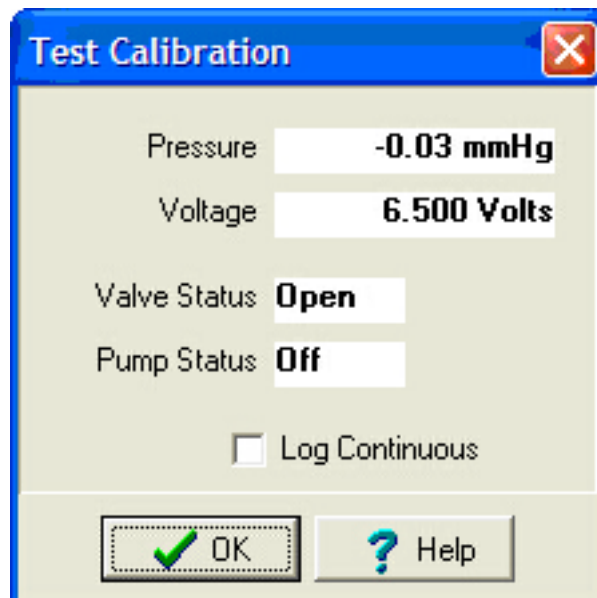
Figure 15. Test Calibration with Open Valve

5. Verify the pressure is at or near zero and the voltage is within 0.2V DC of the power supply (6.5V DC). Verify the valve status is open and the pump status is off.
6. Select **Close Valve** on the UUT. The valve status changes to closed.

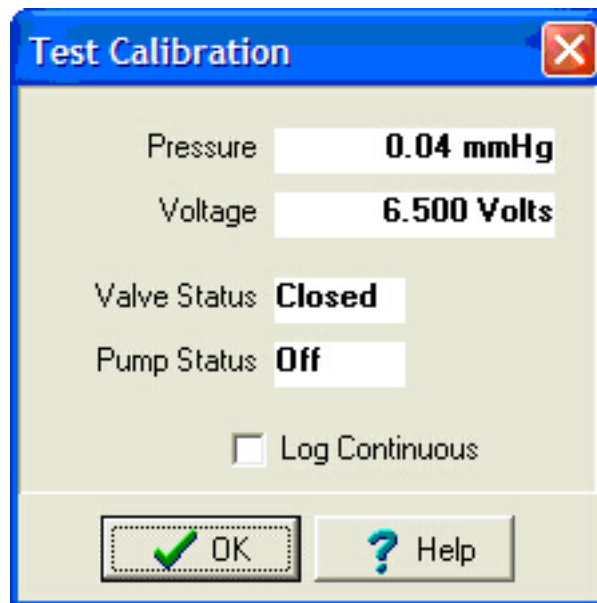
Figure 16. BP Calibration Check Close Valve**Figure 17. Test Calibration with Closed Valve**

7. Select **Start Cuff Inflation**. The pump starts inflating the cuff. Verify the pump status is on and the pressure is rising.

Figure 18. Start Cuff Inflation

8. Inflate the pressure up to 250 mmHg. Select the **Stop Pump** on the UUT to stop the inflation. Fine tune the pressure reading to 250 mmHg with the squeeze bulb.

Figure 19. Fine Tune the Pressure Reading to 250 mmHg

9. Check the reading on the pressure meter against reading on the UUT.
 - a. Verify the pressure on the UUT is within the pressure tolerance in the table. Use the squeeze bulb to fine tune the pressure at each inflation pressure limit. If the pressure is within tolerance, go to the next inflation pressure.

Inflation pressure	Pressure tolerance	Inflation pressure	Pressure tolerance
250 mmHg	+/- 2.0 mmHg	50 mmHg	+/- 1.0 mmHg
150 mmHg	+/- 1.5 mmHg	0 mmHg	+/- 1.0 mmHg

- b. If all readings are within specification, go to [“Functional tests”](#) on page 67.
- c. If the UUT is not within the pressure tolerance, open the valve to bleed pressure to zero. Select **Calibrate > Pressure** on the repair software. Proceed to [“Blood pressure calibration”](#) on page 63. UUT needs calibration.
- d. If replacement of the NIBP board is required, first proceed to [“NIBP board Initialization”](#) on page 62 and then proceed to [“Blood pressure calibration”](#) on page 63.

Blood pressure calibration

Note Complete the voltage calibration before beginning a blood pressure calibration.

If all readings were within specifications during [“Pressure verification test”](#) on page 57, skip this section and go to [“Functional tests”](#) on page 67.

NIBP board Initialization

Note All New NIBP Boards must be initialized before calibration.

1. Power on the UUT in configuration mode by pressing the **Check** and **Power On** buttons on the UUT. Hold the **Check** button until the UUT beeps twice. The configuration screen displays.

Figure 20. Configuration Menu



- Open the Spot LXi Service Tool on the service computer and select **Calibrate > Reset Defaults**. The Reset Defaults window displays.

Figure 21. Reset Defaults Window

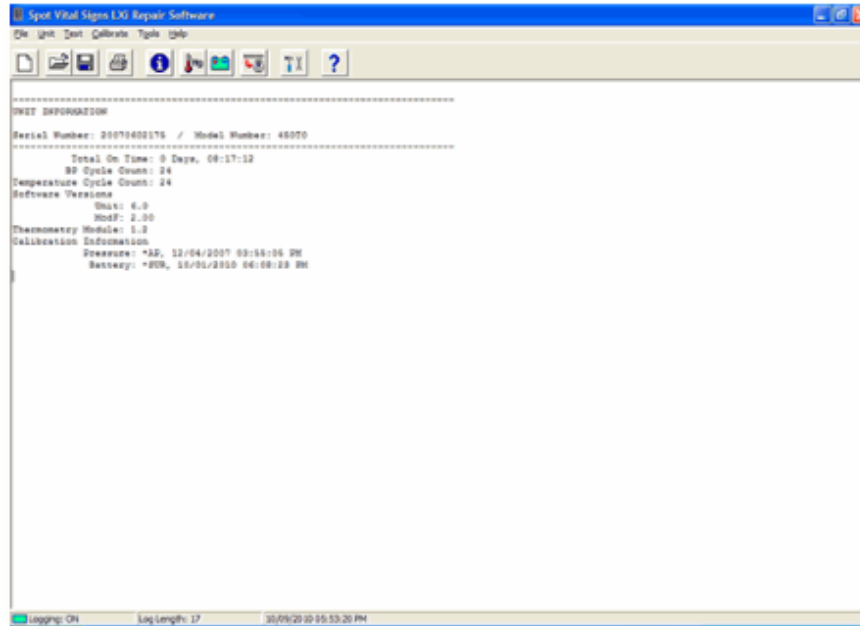

- Click **Reset > Initialize > OK**. The NIBP board is initialized.
- Perform the "Voltage Calibration" on page 55 before proceeding to "Blood pressure calibration".

Blood pressure calibration

- Power on the UUT in configuration mode by pressing the **Check** and **Power On** buttons on the UUT. Hold the **Check** button until the UUT beeps twice.

Figure 22. Blood Pressure Menu



- The configuration screen displays, scroll to **Blood Pressure** and select it. Select **BP Calibration Check**.

Figure 23. BP Calibration Check



- Open the Spot LXi Service Tool on the service computer and select **Calibrate > Pressure**. The Calibrate Pressure window opens.

Figure 24. Calibrate Pressure Window

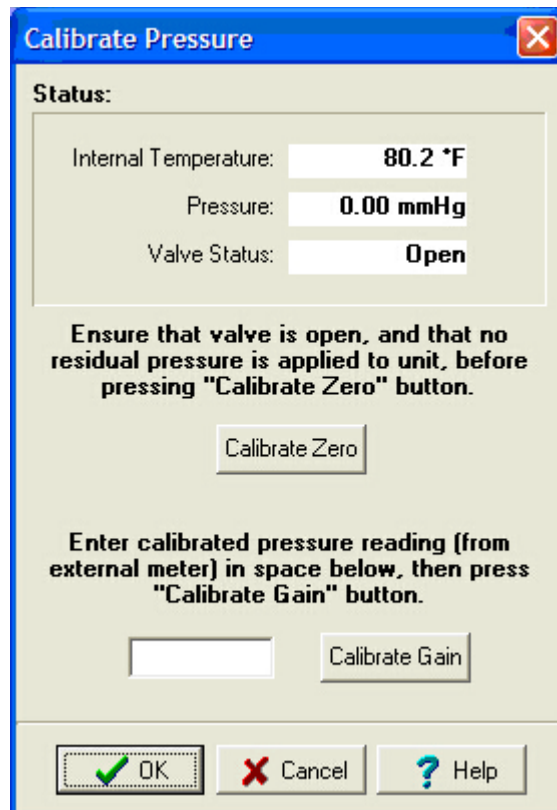

4. Connect the UUT to the pneumatic test assembly using the two-tube blood pressure hose with the Y-fitting. (See “Blood Pressure Hose with Y-fitting” on page 57.)
5. Connect the pneumatic test assembly hose to the 500cc cylinder of the test volume and verify the following:
 - the pressure is at zero mmHg,
 - the bleed screw on squeeze bulb is closed,
 - valve on UUT is in the open state.
6. On the Spot LXi Service Tool select **Calibrate Zero button**. 
7. Close Valve on the UUT and use the squeeze bulb to manually inflate the UUT to 200 mmHg. Let stabilize.

Figure 25. Fine Tune the Pressure Reading to 200 mmHg



8. Enter the pressure meter reading in the **Calibration Gain** field on the service computer. Be as precise as possible. If pressure meter has resolution of 1.00 mmHg make sure it reads 200.00 without switching to 199.00 or 201.00. Enter 200.00 in **Calibration Gain** field.

Figure 26. Calibration Gain Field

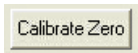
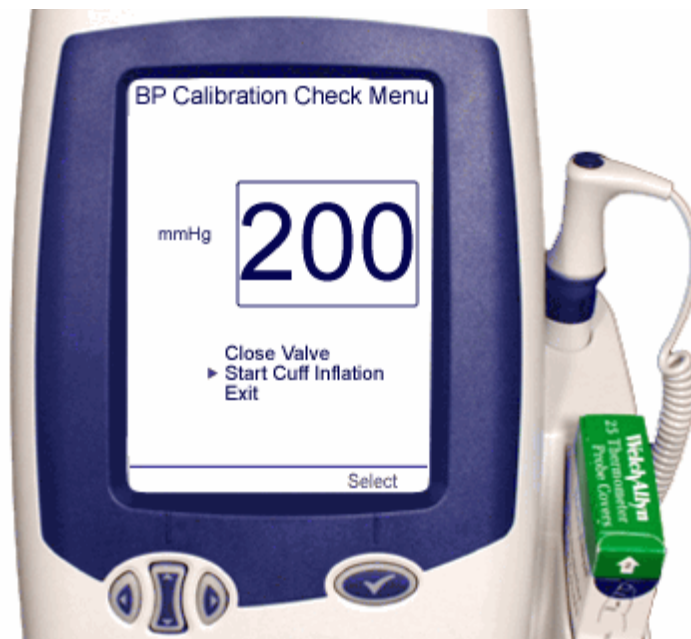
Calibrate Pressure

Status:

Internal Temperature: 80.2 °F

Pressure: 0.00 mmHg

Valve Status: Open

Ensure that valve is open, and that no residual pressure is applied to unit, before pressing "Calibrate Zero" button.

Calibrate Zero

Enter calibrated pressure reading (from external meter) in space below, then press "Calibrate Gain" button.

Calibrate Gain

OK Cancel Help

9. Click **Calibrate Gain** on the service computer.
10. Click **OK** to accept the inputs. Click **Yes** to make the changes permanent.
11. Enter your initials in the **Calibration Signature** field and click **OK**. The UUT resets and powers up in normal mode.

Figure 27. Calibration Signature Field

Calibration Signature

Please enter a three character calibration signature, eg. Your initials DED

Calibration Signature:

OK Cancel

12. Blood Pressure calibration is complete.

Functional tests

Note Perform the Functional Tests sequentially. Fill out the “[Service Work Checklist](#)” on page 111 with the Calibration and Functional Test data obtained as you perform these steps.

Each test is software driven. Selecting the Test button begins the test.

Connect the correct Test Volume cylinder called out in the procedure (in parenthesis below) or the test will fail.

Test specification details:

Leak test	6mm maximum in 15 seconds with a volume of (100cc) at 250 mmHg
Dump test	From 260 to less than 15 mmHg in 10 seconds or less with a volume of (500 cc)
Inflation test	From 5 to 210 mmHg in 7 seconds or less with a volume of (250 cc)
Valve control test	From 160 mmHg with a volume of (100 cc) Open the valve for the following time intervals and pressure drops: <ul style="list-style-type: none"> • 10 msec = 4 to 12 mmHg • 15 msec = 4 to 15 mmHg • 25 msec = 4 to 25 mmHg
Inflation linearity	Connect a standard cuff hose between the UUT and the 500cc Linearity input on the Test Volume and inflate. <ul style="list-style-type: none"> • Measure the pressure at 6, 9, and 12 seconds and compare to the expected readings at these intervals. • Also check the noise level at 7, 10, and 13 seconds into the inflation step.

Functional test steps:

1. If the UUT is connected to the Battery Simulator, set the external power supply to 6.5 +/- 0.1V DC.

Note The Spot LXi AC power adapter should NOT be connected to the UUT.

If the UUT is NOT connected to the battery simulator, connect the Spot LXi AC power adapter to the UUT.

2. Power on UUT in normal mode.
3. Connect the UUT to the pneumatic test assembly using the two-tube blood pressure hose with the Y-fitting. (See “[Blood Pressure Hose with Y-fitting](#)” on page 57.) Verify that the bleed valve on the squeeze ball is closed.
4. Open the Spot LXi Service Tool on the service computer and select **Test > Pneumatics**. The Test Pneumatics window opens.

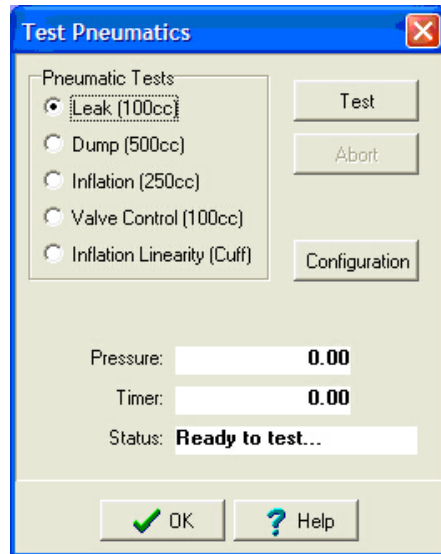
Figure 28. Test Pneumatics Window

- a. Connect the test specific cylinder in parenthesis; (100cc), (500cc), (250cc)
- b. Sequentially select each pneumatic test, starting with "Leak (100cc)". Click **Test**. A successful test will display "Passed".

Figure 29. Passed Leak Test

- c. Perform each of the tests listed after connecting the test specific cylinder. The "Inflation Linearity (Cuff)" test may use the 500cc cylinder in place of the adult cuff.

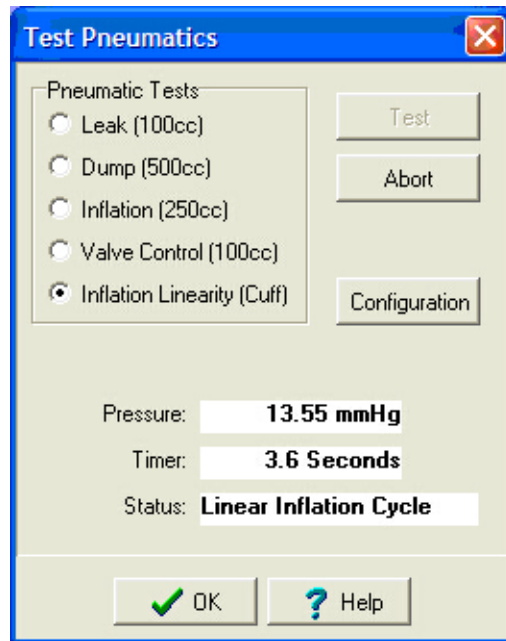
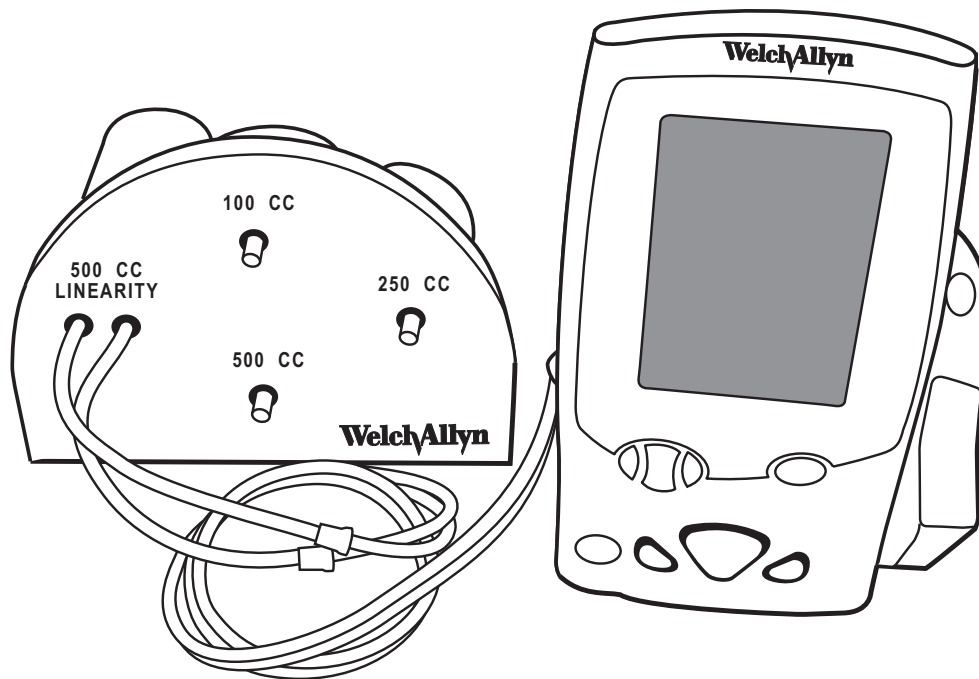
Figure 30. Inflation Linearity Cuff Test**Figure 31. Inflation Linearity 500cc Cylinder**

- d. Click **OK** after completing the last test to close the **Pneumatics** test window.
5. On the Spot LXi Service Tool select **Test > Current Levels**. Perform the tests listed. The Test Current Levels window opens.

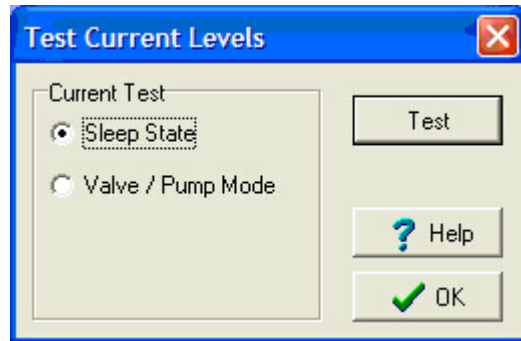
Figure 32. Test Current Levels Window

- a. **Sleep State > Test**, screen is off and the UUT is idle. Verify that the current is less than 500 mA. Click **OK** after completing the measurement.

Figure 33. Sleep State

- b. **Valve/pump Mode > Test**, the UUT is fully active with the valve closed and the pump running. Verify that the current is less than 2.0 amperes in this state. Click **OK** after completing the measurement.
 - c. Normal Mode; screen is lit, but the UUT is inactive. The UUT current draw is less than 1.25 amperes in this state.
 - d. Click **OK** after completing the last test to close the **Test Current Levels** window.
6. On the Spot LXi Service Tool select **Test > Noise Levels > Test**. The **Test Noise Levels** window opens.

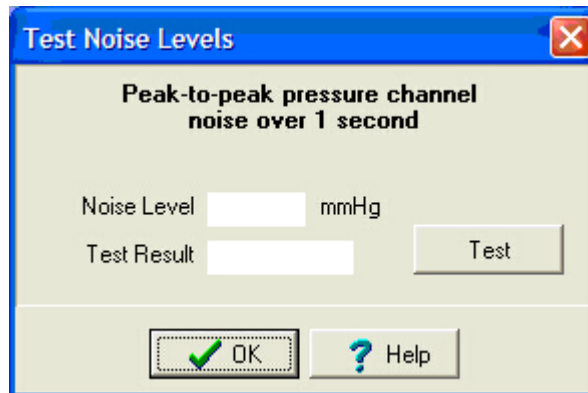
Figure 34. Test Noise Levels Window

- a. The Test Noise Levels test measures the amount of noise on the UUT A-D pressure channel. The sample is 1 second in length with 0 mmHg applied. The maximum allowed noise is .050 mmHg.
 - b. Click **OK** after completing the test to close the **Test Noise Levels** window.
7. On the Spot LXi Service Tool select **Test > Buttons**. The **Test Buttons** window opens.

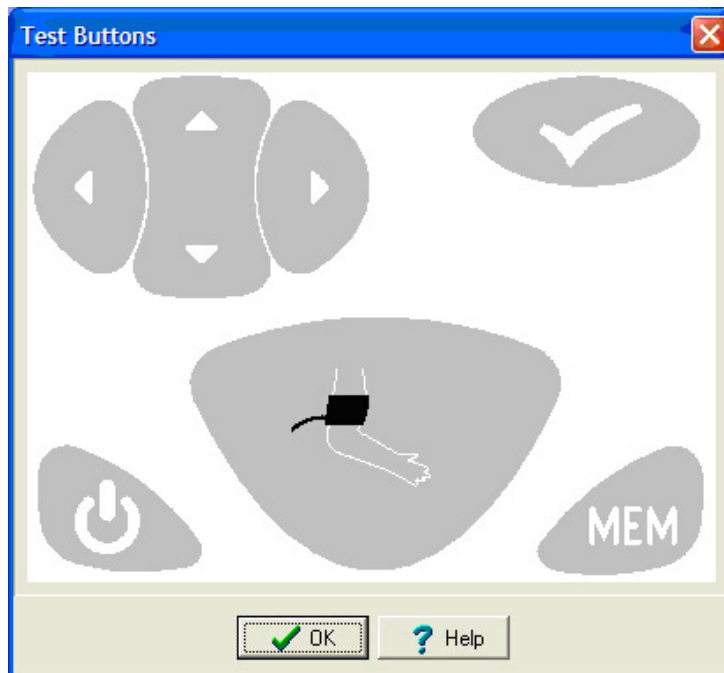
Figure 35. Test Buttons

- a. Press each button on the UUT and verify the appropriate button lights on the Spot LXi Service Tool window.

Figure 36. UUT Buttons



- b. Click **OK** after completing the test to close the **Buttons Test** window.
- 8. On the Spot LXi Service Tool select **Test > Interface**. The **Test Interface** window opens.

Figure 37. Test Interface Window

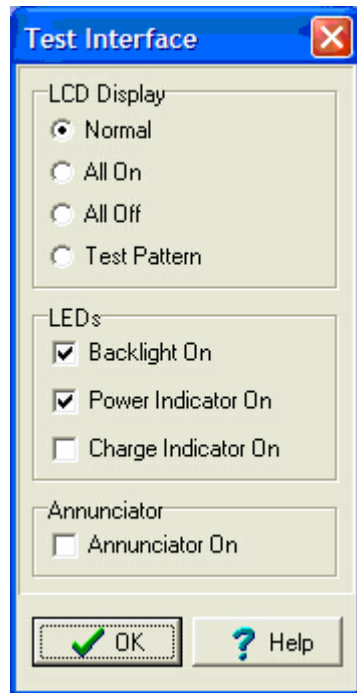

- a. Perform all commands in this test, verifying the screen on the UUT responds correctly with each command:

Normal	
All On	
All Off	
Test Pattern	
Backlight On/Off, = blank dark UUT display screen	

Power Indicator On/Off	
Charge Indicator On/Off	
Enunciator On/Off, Toggles enunciator tone on and off.	

Figure 38. Normal



Figure 39. All On



Figure 40. All Off



Figure 41. Test Pattern



Figure 42. Backlight On/Off**Figure 43. Power Indicator On/Off****Figure 44. Charge Indicator On/Off**

- b. Click **OK** after completing the tests to close the **Test Interface** window.

To perform the over pressure test:

1. Verify that the UUT is in normal mode.
2. Re-install the pneumatic test assembly with the 250cc cylinder connected.
3. On the Spot LXi Service Tool select **Unit >Status**. A **Unit Status** window displays.

Figure 45. Unit Status Window

The screenshot shows the 'Unit Status' window with the following information:

- Status Information** | POST Errors
- Unit Status:**
 - Powerup Mode: **Configuration**
 - Charge State: **Battery**
 - Battery Level: **Above 6.15 Volts**
- ModF Status:**
 - Module State: **Dumping**
- Hardware/Patient States:**
 - Valve Status: **Open**
 - Pump Status: **Off**
 - Malfunction (E11): **No**
- Safety States:**
 - Over Pressure: **No**
 - Autozero Failure: **Yes**
 - Battery Failure: **No**
 - Ambient Out Of Range: **No**
 - Unrecoverable POST: **No**
 - Residual Pressure Failure: **No**
- Cuff Pressure: **0.00 mmHg**
- Log Status Information (circled in blue)

Buttons at the bottom: **OK** (with a green checkmark) and **Help** (with a question mark).

4. Check the **Log Status Information** box in the lower right hand corner of the Spot LXi Service Tool. The Event logs display in rapid succession.
5. Immediately initiate a blood pressure reading. As the pressure increases, start applying additional pressure with the squeeze bulb.
6. Increase the pressure to the UUT until an E10 error displays.
7. Uncheck the **Log Status Information** box and click **OK** after completing the test to close the **Unit Status** box.

Scroll through the event log to locate the last 'no' answer, directly followed by the first 'yes' answer in the column labeled over pressure.

Figure 46. Event Log

Battery Level	State	Valve State	Pump State	E11	Over Pressure	ModF Status
ATT_LEVEL_1	Inflating	Closed	On	No	No	No
ATT_LEVEL_1	Inflating	Closed	On	No	No	No
ATT_LEVEL_1	Inflating	Closed	On	No	No	No
ATT_LEVEL_1	Inflating	Closed	On	No	No	No
ATT_LEVEL_1	Inflating	Closed	On	No	No	No
ATT_LEVEL_1	Inflating	Closed	On	No	No	No
ATT_LEVEL_1	Inflating	Closed	On	No	No	No
ATT_LEVEL_1	Inflating	Closed	On	No	No	No
ATT_LEVEL_1	Inflating	Closed	On	No	No	No
ATT_LEVEL_1	Inflating	Closed	On	No	No	No
ATT_LEVEL_1	Inflating	Closed	On	No	No	No
ATT_LEVEL_1	Inflating	Closed	On	No	No	No
ATT_LEVEL_1	Inflating	Closed	On	No	No	No
ATT_LEVEL_1	Inflating	Closed	On	No	No	No
ATT_LEVEL_1	Inflating	Closed	On	No	No	No
ATT_LEVEL_1	Inflating	Closed	On	No	No	No
ATT_LEVEL_1	Inflating	Closed	On	No	No	No
ATT_LEVEL_1	Inflating	Closed	On	No	No	No
ATT_LEVEL_1	Inflating	Closed	On	No	No	No
ATT_LEVEL_1	Inflating	Closed	On	No	No	No
ATT_LEVEL_1	Inflating	Closed	On	No	No	No
ATT_LEVEL_1	Inflating	Closed	Off	No	No	No
ATT_LEVEL_1	Inflating	Closed	Off	No	No	No
ATT_LEVEL_1	Dumping	Open	Off	No	Yes	No
ATT_WARN	Dumping	Open	Off	No	Yes	No
ATT_WARN	Dumping	Open	Off	No	Yes	No
ATT_WARN	Dumping	Open	Off	No	Yes	No

8. Scroll to the right to see the mmHg pressure that these events occurred.
9. Select the higher pressure reading when the E10 error occurred. Verify the pressure is between 296 and 329 mmHg.

Note The following tests are for verification only. There is no updating of calibration parameters.

Temperature Functional Check

Temperature test setup

The 9600 Plus Calibration Tester takes approximately 20 minutes to heat to the lowest setting. When testing several thermometers at all three temperatures, it is recommended to test all probes at one Calibration Set Point Temperature before proceeding to the next Calibration Set Point Temperature.

To further expedite testing start at the lowest Calibration Set Point Temperature. The 9600 Plus Calibration Tester does not have an internal fan, this causes a longer cool down time than warm up time.

Refer to the 9600 Plus Calibration Tester Directions for Use manual for specific information regarding the LCD window or the control buttons.

1. Choose the proper mains plug insert and slide it over the two prongs in the power converter.

Figure 47. Power Adapter and Mains Plug Inserts

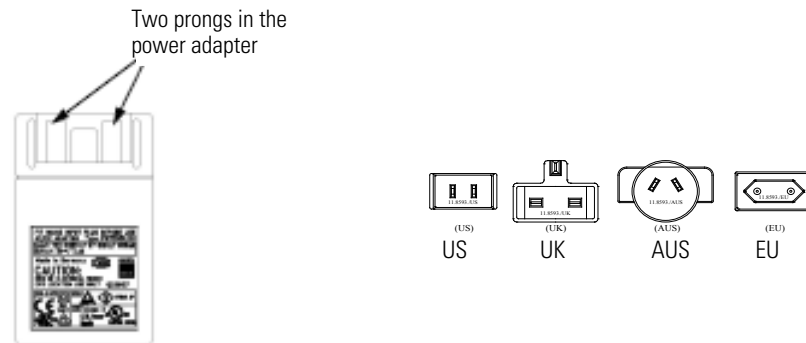

2. Plug the power adapter into the 9600 Plus Calibration Tester and the opposite end into a wall outlet.
3. Place the 9600 Plus Calibration Tester on a level surface away from sunlight, drafts, and other sources of heat or cold.
4. Observe the Set Point Mode in the upper left hand corner of the LCD display. If the unit displays a "D", it is in Default Mode and will heat to the lowest Set Point Temperature. If you do not want to conduct testing at this Set Point Temperature, press and hold the **Temperature Selection** button to select the desired setting. The temperature display will flash before staying on continuously to indicate the 9600 Plus Calibration Tester has stabilized and is ready for use.

Changing the Calibration Set Point Temperature on the 9600 Plus Calibration Tester

To scroll from one set point to the next, press and hold the **Temperature Selection** button (up/down button) until a beep is heard. The newly selected set point appears in the upper left corner of the LCD display. The device's current temperature is displayed, starts to flash, and continues flashing until the cavity reaches the equilibrium at the new set point.

Welch Allyn SureTemp Plus Thermometers



Caution Store thermometers for testing in the same room as the 9600 Plus Calibration Tester for approximately 30 minutes prior to testing to allow for thermal accommodation.

To begin functional verification of the SureTemp Plus thermometer:

1. Verify that the UUT is ON and is operating in normal mode.
2. Remove the thermometer probe from the probe well and clean it with either a 70% isopropyl alcohol solution, or a 10% chlorine bleach solution. Let the thermometer air dry. Do not apply a probe cover.
3. Verify that the blue (oral) probe well is in place.

Insert the thermometer into the 9600 Plus Calibration Tester device thermistor device port (small port).

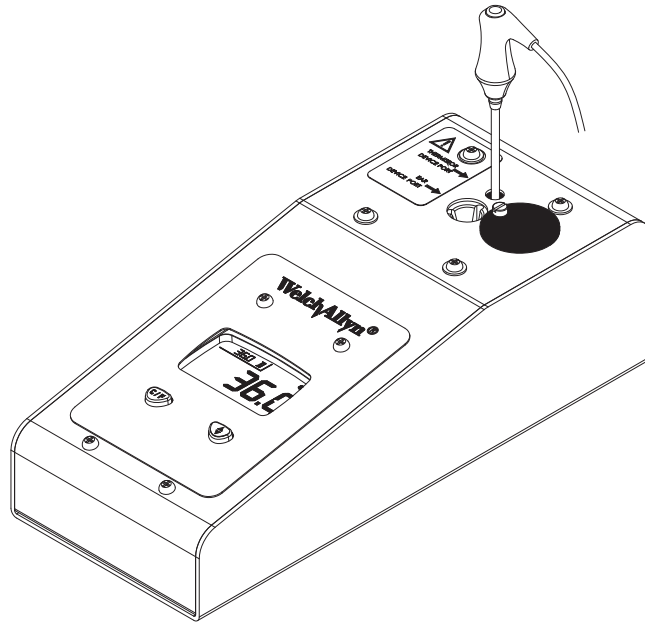
Figure 48. 9600 Plus Calibration Tester with the Welch Allyn SureTemp Plus Thermometer

4. Verify that the thermometer enters Monitor Mode, (approximately one minute), the snail symbol and "Monitor" are displayed on the UUT display.

Figure 49. Temperature Monitor Mode

5. After the UUT enters "Monitor" mode wait for approximately one minute or until the temperature on the thermometer is stable for ten seconds.
 - a. Verify that the UUT thermometer's temperature reading is within the temperature tolerance in the table.

Calibration Set Point Temperature	Temperature tolerance
96.8°F (36.0°C)	+/- 0.2°F (+/- 0.1°C)
105.8°F (41.0°C)	+/- 0.2°F (+/- 0.1°C)

- b. When verifying several UUT thermometers at both temperatures, it is recommended to verify all UUT thermometers at one Calibration Set Point Temperature before proceeding to the next Calibration Set Point Temperature.

- c. Changing the Calibration Set Point Temperature (9600 Plus Calibration Tester):

To scroll from one set point to the next, press and hold the **Temperature Selection** button (up/down button) until a beep is heard. The newly selected set point appears in the upper left corner of the LCD display. The device's current temperature is displayed, starts to flash, and continues flashing until the cavity reaches the equilibrium at the new set point.

To begin functional verification of SureTemp Plus without thermometer (Optional):

If the UUT fails the temperature verification using the SureTemp Plus thermometer; then perform this separate functional test of the UUT temperature circuitry.

1. Remove probe and probe well completely.
2. Insert calibration key (part number 06138-000) and replace probe well.

Figure 50. Calibration Key and Probe Well



3. Insert and then remove probe from probe storage channel to reset thermometer.

Figure 51. Reset Thermometer

4. Wait for display test, and then observe display.
5. Display should read $36.3^{\circ}\text{C} \pm 0.1^{\circ}\text{C}$ or $97.3^{\circ}\text{F} \pm 0.2^{\circ}\text{F}$.

Figure 52. Temperature Display in F°

6. Remove calibration key and install probe well.
7. If the UUT temperature circuitry verified successfully and the temperature verification failed using thermometer probe; then replace SureTemp Plus thermometer probe.

Braun ThermoScan Pro 4000



Caution Store thermometers for testing in the same room as the 9600 Plus Calibration Tester for approximately 30 minutes prior to testing to allow for thermal accommodation.

To begin functional verification of the Braun ThermoScan PRO 4000 thermometer:

1. Clean the probe tip with a cotton swab slightly moistened with isopropyl alcohol, remove excess alcohol with a clean cotton swab, and let air dry for 5 minutes. Do not use any chemical other than alcohol to clean the probe window.
2. Place the Braun ThermoScan Pro 4000 in Calibration Mode using the following steps.
 - a. Push and release the **I/O mem** button to turn the product on. The display shows symbols and functions. The Braun ThermoScan Pro 4000 performs an automatic self check. After a few seconds you hear a beep and see two dashed lines, a sound symbol, and ° C or ° F on the display.

Figure 53. Braun Self Check



- b. Push the **I/O mem** button again and keep it pressed for the following steps:
 - After approx. 3 seconds the “OFF” symbol flashes on the display (keep pressing the button).
 - When you hear a beep, release the button immediately.
 - The Braun TheromScan Pro 4000 is now in calibration check mode and the display is flashing and showing the “CAL” symbol.
 - Apply a new probe cover. Insert the Braun ThermoScan Pro 4000 into the 9600 Plus Calibration Tester ear device port (large port). Place the probe firmly into the ear device port.

Figure 54. Braun Ear Device Port

3. Wait approximately three seconds, press the thermometer **start** button, and watch for the "Exac Temp" light to flash.

Figure 55. Press Start Button

4. Leave the thermometer in the 9600 Plus Calibration Tester until you hear a beep. Remove the Pro 4000 Thermometer from the 9600 Plus Calibration Tester and read the temperature in the thermometer's display.
 - a. Verify that the UUT thermometer's temperature reading is within the temperature tolerance in the table.

Calibration Set Point Temperature	Temperature tolerance
96.8°F (36.0°C)	+/- 0.2°F (+/- 0.1°C)
105.8°F (41.0°C)	+/- 0.2°F (+/- 0.1°C)

- b. Wait one full minute before taking another reading with the same thermometer. Repeated measurements in short sequence may cause higher readings.
 - c. When verifying several UUT thermometers at both temperatures, it is recommended to verify all UUT thermometers at one Calibration Set Point Temperature before proceeding to the next Calibration Set Point Temperature.
 - d. Changing the Calibration Set Point Temperature (9600 Plus Calibration Tester):

To scroll from one set point to the next, press and hold the **Temperature Selection** button (up/down button) until a beep is heard. The newly selected set point appears in the upper left corner of the LCD display. The device's current temperature is displayed, starts to flash, and continues flashing until the cavity reaches the equilibrium at the new set point.
5. The Braun ThermoScan PRO 4000 thermometer will exit CAL mode after four minutes.

To begin functional verification of the Braun ThermoScan PRO 4000 thermometer Down Load:

1. Clean the probe tip with a cotton swab slightly moistened with isopropyl alcohol, remove excess alcohol with a clean cotton swab, and let air dry for 5 minutes. Do not use any chemical other than alcohol to clean the probe window.
2. Insert the Braun ThermoScan PRO 4000 thermometer into the UUT and wait for the "Exac Temp" light to go out.

Figure 56. Braun Exac Temp Light

3. Remove the Braun ThermoScan PRO 4000 thermometer from the UUT.
4. Apply a new probe cover. Insert the Braun ThermoScan Pro 4000 into the 9600 Plus Calibration Tester ear device port (large port). Place the probe firmly into the large port. See (Figure 54) "Braun Ear Device Port" on page 83. The temperature selection is non-specific for this particular test.
5. Wait approximately three seconds, press the thermometer **Start** button, and watch for the "Exac Temp" light to flash. See "Braun Exac Temp Light".
6. Leave the thermometer in the 9600 Plus Calibration Tester until you hear a beep. Remove the Pro 4000 Thermometer from the 9600 Plus Calibration Tester and read the temperature in the thermometer's display.
7. Insert the Braun ThermoScan PRO 4000 thermometer into the UUT (should be on and in normal mode). The reading from the Braun ThermoScan PRO 4000 thermometer should transfer automatically to the UUT display. Verify this action.

Changing the Calibration Set Point Temperature

To scroll from one set point to the next, press and hold the Temperature Selection button until a beep is heard. The newly selected set point appears in the upper left corner of the LCD display. The device's current temperature is displayed, starts to flash, and continues flashing until the cavity reaches the equilibrium at the new set point.

To begin functional verification of the Masimo SpO2

Use the "Masimo Tester" to verify the Masimo SpO2 functionality.

Figure 57. Masimo Tester

1. With the UUT OFF, orient the Masimo Tester such that the mini-D connector mates with the SpO2 connector on the UUT; or use appropriate Masimo extension cable to connect the Masimo Tester and UUT.
2. Power ON the Spot LXi UUT and confirm the SpO2 reading in the Display Window is $81\% \pm 3\%$ and the pulse reading is $61 \text{ bpm} \pm 1 \text{ bpm}$.

Figure 58. SpO2 Reading

3. Place the thumb and index finger on the gray buttons on either side of the Masimo Tester connector or extension cable connector; press the buttons firmly, and gently pull to remove the tester.

Note The functionality of the SpO2 module is not adjustable. If the SpO2 is not functioning properly, or the SpO2 and pulse performance cannot be verified against the calibrated simulator, contact Welch Allyn Technical Support [page iv](#).

To begin functional verification of the Nellcor SpO2

Use a Nellcor-approved SpO2 simulator (SRC-MAX) to verify the Nellcor SpO2 functionality.

Figure 59. Nellcor SpO2 Simulator



1. With the UUT ON and completely booted, orient the simulator such that the connector mates with the SpO2 connector on the UUT; or use appropriate Nellcor extension cable to connect the simulator and UUT.

Note The UUT MUST be powered on prior to connecting the Nellcor SpO2 simulator.

2. On the Nellcor simulator change the SpO2 percentage from default 75% to 90%.
3. Confirm the SpO2 reading in the Display Window is $90\% \pm 1\%$ and the pulse reading is $60 \text{ bpm} \pm 1 \text{ bpm}$.

Figure 60. SpO2 Reading and Pulse Reading

4. Remove the simulator by placing the thumb and index finger on either side of the simulator connector or extension cable connector; press the buttons firmly and gently pull to remove.

Note The functionality of the SpO2 module is not adjustable. If the SpO2 is not functioning properly, or the SpO2 and pulse performance cannot be verified against the calibrated simulator, contact Welch Allyn Technical Support [page iv](#)

7 Specifications

Performance

This section describes normal ranges for Spot Vital Signs LXi.

Blood Pressure Accuracy

Blood pressure accuracy meets or exceeds AAMI SP10:2002 standards for non-invasive blood pressure accuracy (± 5 mmHg mean error, 8 mmHg standard deviation). Blood pressure accuracy is validated for pressure measurement using the upper arm only.

Cuff Pressure Range	0 to 300 mmHg
Systolic Range	60 to 250 mmHg
Diastolic Range	30 to 160 mmHg
Blood Pressure Determination Time	Typical: 15 seconds
Mean Arterial Pressure Range	40 to 190 mmHg
Pulse Rate Range (using SpO₂ determination)	25 to 240 bpm
Pulse Rate Range (using Blood Pressure determination)	35 to 199 bpm
Pulse Rate Accuracy (using SpO₂ determination)	Without Motion: 25 to 245 bpm ± 3 digits ¹ With Motion: normal physiologic range (55 to 125 bpm) ± 5 digits Low Perfusion: 25 to 245 bpm ± 3 digits ¹
Pulse Rate Accuracy (using Blood Pressure determination)	$\pm 5.0\%$
Overpressure Cutoff	315 mmHg ± 15 mmHg

¹ Specification applies to device performance and was validated with Biotek and Nellcor simulators.

Temperature Specifications

Temperature Range

SureTemp Plus	80° to 110° F (26.7° to 43.3° C)
Braun ThermoScan PRO 4000	68° to 108° F (20° to 42.2° C)

Calibration Accuracy

SureTemp Plus	±0.2° F (0.1° C) (Monitor Mode)
Braun ThermoScan PRO 4000 for displayed temperature ranges	± 0.4° F (±0.2° C) 95.9° to 107.6° F (35.5° to 42° C) ±0.5° F (±0.25° C) (outside this temperature range)

Display Resolution

0.1° F or ° C

SureTemp Plus Predict Time

Oral	Approx. 4 to 6 seconds
Adult Axillary	Approx. 12 to 15 seconds (age 18 years and older)
Pediatric Axillary	Approx. 10 to 13 seconds (age 17 years and younger)
Rectal	Approx. 10 to 13 seconds

SpO₂ Specifications

Masimo Sensor Accuracy Guide

Accuracy specified when used with Masimo SET pulse oximetry monitors or with licensed Masimo SET pulse oximetry modules using PC series patient cables, during no motion. Numbers present ± 1 standard deviation. Plus or minus one standard deviation represents 68% of the population. SpO₂ accuracy from 70% to 100%. Pulse rate accuracy from 25 to 240 bpm.

Performance Measurement Range	SpO ₂ : 1 to 100% Pulse Rate: 25 - 240 beats per minute (BPM)
Perfusion	0.02% to 20%
Accuracy	Saturation: 70% to 100% No Motion: Adults, Pediatrics ± 2 digits Neonates ± 3 digits Motion: Adults, Pediatrics ± 3 digits Neonates ± 3 digits Low Perfusion: Adults, Pediatrics ± 2 digits Neonates ± 3 digits
Pulse Rate Accuracy	Pulse Rate: 25 to 250 bpm No Motion: Adults, Pediatrics, Neonates ± 3 digits Motion: Adults, Pediatrics, Neonates ± 5 digits Low Perfusion: Adults, Pediatrics, Neonates ± 5 digits

Table 1. Masimo Sensor Accuracy Guide

Sensor	Weight Range	Saturation Accuracy		Pulse Rate Accuracy	
		No Motion	Motion	No Motion	Motion
LNOP-ADT	> 30 kg	$\pm 2\%$	$\pm 3\%$	± 3 bpm	± 5 bpm
LNOP-PDT	10 to 50 kg	$\pm 2\%$	$\pm 3\%$	± 3 bpm	± 5 bpm
LNOP-NEO	< 10 kg	$\pm 3\%$	$\pm 3\%$	± 3 bpm	± 5 bpm
LNOP-NEOPT	< 1 kg	$\pm 3\%$	$\pm 3\%$	± 3 bpm	± 5 bpm
LNOP-DCI	> 30 kg	$\pm 2\%$	$\pm 3\%$	± 3 bpm	± 5 bpm
LNOP-DCIP	10 to 50 kg	$\pm 2\%$	$\pm 3\%$	± 3 bpm	± 5 bpm

Masimo Patents

The Masimo sensors and cables are covered under one or more of the following U.S.A. patents: 5,758,644; 5,823,950; 6,011,986; 6,157,850; 6,263,222; 6,501,975; and other applicable patents listed at www.masimo.com/patents.htm.

Nellcor Sensor Accuracy Guide

Accuracy specifications are based on controlled hypoxia studies with healthy, non-smoking adult volunteers over the specified saturation SpO₂ range. Pulse oximeter SpO₂ readings were compared to SaO₂ values of drawn blood samples measured by hemoximetry. All accuracies are expressed as \pm "X" digits. This variation equals \pm one standard deviation (\pm 1 SD), which encompasses 68% of the population.

Table 2. OxiMax Sensor Models, Single Patient Use

Sensor Models	SpO ₂ Range 70% to 100%
MAX-AI ¹	\pm 2
MAX-PI*	\pm 2
MAX-II	\pm 2
MAX-RI ²	\pm 3.5

¹ The accuracy specification under motion conditions is \pm 3. For a definition of motion, contact Nellcor Technical Services or your local Nellcor representative.

² The accuracy specification has been determined between saturations of 80% to 100%.

Table 3. OxiCliq Sensor Models, Single Patient Use

Sensor Models	SpO ₂ Range 70% to 100%
OXICLIQ-PI	\pm 2.5

Table 4. Reusable Sensor Models

Sensor Models	SpO ₂ Range 70% to 100%
D-YS (Infant to Adult)	\pm 3
D-YS and D-YSE	\pm 3.5
D-YS and D-YSPD	\pm 3.5
DS-100A	\pm 3
OXI-A/N (Adult/neonate)	Adult: \pm 3 Neonate: \pm 4
OXI-P/I (Pediatric/infant)	\pm 3

Nellcor Patents

Covered by one or more of the following U.S. patents and foreign equivalents:

5,485,847; 5,676,141; 5,743,263; 6,035,223; 6,226,539; 6,411,833; 6,463,310; 6,591,123; 6,708,049; 7,016,715; 7,039,538; 7,120,479; 7,120,480; 7,142,142; 7,162,288; 7,190,985; 7,194,293; 7,209,774; 7,212,847; 7,400,919.

Mechanical

Dimensions	Height: 10.63" (27 cm) Length/Braun: 8" (20.32 cm) Length/SureTemp Plus: 7.5" (19 cm) Depth: 5.25" (13.34 cm)
Weight	7.5 lbs (3.4 kg)
Mounting	Self-supporting on rubber feet Custom mobile stand Custom wall mount
Portability	May be hand-carried when held by the rear handle

Electrical

Power Requirements	Patient-rated isolation transformer is connected to AC mains: 100-240V, 50-60Hz, 0.4A or internal power: 6Vdc, 6Ah
---------------------------	---

Patents

For patent information, please visit www.welchallyn.com/patents

Batteries

Spot Vital Signs LXi	Sealed Lead Acid Battery (4500-84) with external charger (4500-101A)
Braun ThermoScan PRO 4000 thermometer	Rechargeable Battery Pack (53020-0000)
External Printer	Ni-Mh Rechargeable Battery Pack (4500-505) Includes a separate charger (713703 or BC1300M)

- The Spot Vital Signs LXi battery is 90 to 100% charged after 6 hours of charging. The Spot LXi battery automatically charges when Spot LXi is powered through the AC power transformer. An operator can use the device while the battery is charging; however, the battery charges faster when the instrument is not in operation.
- The rechargeable batteries in the Braun ThermoScan PRO 4000 thermometer require an additional 1 hour to charge.
- Charge the external printer battery 9 hours before initial use.

Environmental



WARNING This device is not suitable for use in the presence of a flammable anesthetic mixture with air or oxygen or nitrous oxide. An explosion may result.

Operating Temperature	50° to 104° F (10° to 40° C)
Storage/Transport Temperature	Device with SureTemp Plus: -13° to 131°F (-25° to 55°C) Device with Braun ThermoScan PRO 4000: -4° to 122°F (-20° to 50°C)
Relative Humidity	15 to 95% (non-condensing)
Operating Altitude	-557 to 16,000 ft. (-170 to 4877 m)

Radio

Mechanical

Dimensions	3.93" L x 2.38" W x 1.42" T 99.78mm L x 60.5 mm W x 36.1mm T
Mounting	Nylon Bracket
Operating Temperature	-40° C to +85° C
Storage Temperature	-40° C to +125° C

Configuration Options

DHCP Enabled or Not	If not DHCP:					
	<ul style="list-style-type: none"> • IP Address • Subnet Address • Default Gateway Address • Primary DNS 					
Encryption	Wireless Security Mode	Disabled	WEP 64-bit	WEP 128-bit	WPA2-PSK	WPA2-AES
	WPA2 Security (WPA2-PSK and WPA2-AES only)	CCMP	CCMP and TKIP			
	EAP Settings (WPA2-AES only)	EAP Type	TLS	TTLS	PEAP	Auto
Channel						
Default WEP Key 1-4						
SSID	WEP Authentication					
WPA Pass Phrase						
WPA2 Pass Phrase	PSK Format	Hexadecimal	ASCII			

Guidance and Manufacturer's Declaration For Spot Vital Signs LXi Radio

Emissions and Immunity Information

Electromagnetic Emissions

The Spot Vital Signs LXi is intended for use in the electromagnetic environment specified below. The customer or user of the Spot Vital Signs LXi should assure that it is used in such an environment.

Emissions Test	Compliance	Electromagnetic Environment - Guidance
RF emissions CISPR 11	Group 1	The Spot Vital Signs LXi uses RF energy only for its internal function. Therefore, its RF emissions are very low and are not likely to cause any interference in nearby electronic equipment.
RF emissions CISPR 11	Class B	The Spot Vital Signs LXi is suitable for use in all establishments, including domestic establishments and those directly connected to the public low-voltage power supply network that supplies buildings used for domestic purposes.
Harmonic emissions IEC 61000-3-2	Class A	
Voltage fluctuations/ flicker emissions IEC 61000-3-3	Complies	

Electromagnetic Immunity

The Spot Vital Signs LXi is intended for use in the electromagnetic environment specified below. The customer or user of the Spot Vital Signs LXi should assure that it is used in such an environment.

Immunity Test	IEC 60601 Test Level	Compliance Level	Electromagnetic Environment - Guidance
Electrostatic discharge (ESD) IEC 61000-4-2	± 6 kV contact ± 8 kV air	± 6 kV contact ± 8 kV air	Floors should be wood, concrete, or ceramic tile. If floors are covered with synthetic material, the relative humidity should be at least 30%.
Electrical fast transient/ burst IEC 61000-4-4	±2 kV for power supply lines ±1 kV for input/output lines	±2 kV for power supply lines ±1 kV for input/output lines	Mains power quality should be that of a typical commercial or hospital environment.
Surge IEC 61000-4-5	±1 kV differential mode ±2 kV common mode	±1 kV differential mode ±2 kV common mode	Mains power quality should be that of a typical commercial or hospital environment.

Voltage dips, short interruptions, and voltage variations on power supply input lines. IEC 61000-4-11	>95% dip in 0.5 cycle 60% dip in 5 cycles 30% dip for 25 cycles >95% dip in 5 seconds	>95% dip in 0.5 cycle 60% dip in 5 cycles 30% dip for 25 cycles >95% dip in 5 seconds	Mains power quality should be that of a typical commercial or hospital environment. If the user of the Spot Vital Signs LXi requires continued operation during power mains interruptions, it is recommended that the Spot Vital Signs LXi be powered from an uninterruptible power supply or battery.
Power frequency (50/60Hz) magnetic field IEC 61000-4-8	3 A/m	3 A/m	Power frequency magnetic fields should be at levels characteristic of a typical location in a typical commercial or hospital environment.

Electromagnetic Immunity

The Spot Vital Signs LXi is intended for use in the electromagnetic environment specified below. The customer or user of the Spot Vital Signs LXi should assure that it is used in such an environment.

Immunity Test	IEC 60601 Test Level	Compliance Level	Electromagnetic Environment - Guidance
Conducted RF IEC 61000-4-6	3 Vrms 150 kHz to 80 MHz	3 Vrms	Portable and mobile RF communications equipment should be used no closer to any part of the Spot Vital Signs LXi, including cables, than the recommended separation distance calculated from the equation applicable to the frequency of the transmitter. Recommended separation distance $d = (1.17) \sqrt{P}$
Radiated RF IEC 61000-4-3	3 V/m 80 MHz to 2.5 GHz	3 V/m	$d = (1.17) \sqrt{P}$ 80 MHz to 800 MHz $d = (2.33) \sqrt{P}$ 800 MHz to 2.5 GHz where P is the maximum output power rating of the transmitter in watts (W) according to the transmitter manufacturer and d is the recommended separation distance in metres (m). Field strengths from fixed RF transmitters, as determined by an electromagnetic site survey, ^a should be less than the compliance level in each frequency range. ^b Interference may occur in the vicinity of equipment marked with the following symbol: 

Note 1: At 80 MHz and 800 MHz, the higher frequency range applies.

Note 2: These guidelines may not apply in all situations. Electromagnetic propagation is affected by absorption and reflection from structures, objects, and people.

^a Field strengths from fixed transmitters, such as base stations for radio (cellular/cordless) telephones and land mobile radios, amateur radio, AM and FM radio broadcast and TV broadcast cannot be predicted theoretically with accuracy. To assess the electromagnetic environment due to fixed RF transmitters, an electromagnetic site survey should be considered. If the measured field strength in the location in which the Spot Vital Signs LXi is used exceeds the applicable RF compliance level above, the electrocardiograph should be observed to verify normal operation. If abnormal performance is observed, additional measures may be necessary, such as reorienting or relocating the electrocardiograph.

^b Over the frequency range 150 kHz to 80 MHz, field strengths should be less than 3 V/m.

Recommended Separation Distances Between Portable and Mobile RF Communications Equipment and the Spot Vital Signs LXi

The Spot Vital Signs LXi is intended for use in an electromagnetic environment in which radiated RF disturbances are controlled. The customer or user of the Spot Vital Signs LXi can help prevent electromagnetic interference by maintaining a minimum distance between portable and mobile RF communications equipment (transmitters) and the Spot Vital Signs LXi as recommended below, according to the maximum output power of the communications equipment.

Rated Max. Output Power of Transmitter (W)	Separation Distance According to Frequency of Transmitter (m)		
	150 kHz to 80 MHz $d = (1.17) \sqrt{P}$	80 MHz to 800 MHz $d = (1.17) \sqrt{P}$	800 MHz to 2.5 GHz $d = (2.33) \sqrt{P}$
0.01	0.117	0.117	0.233
0.1	0.37	0.37	0.74
1	1.17	1.17	2.33
10	3.70	3.70	7.37
100	11.70	11.70	23.30

For transmitters rated at a maximum output power not listed above, the recommended separation distance d in meters (m) can be estimated using the equation applicable to the frequency of the transmitter, where P is the maximum output power rating of the transmitter in watts (W) according to the transmitter manufacturer.

Note 1: At 80 MHz and 800 MHz, the separation distance for the higher frequency range applies.

Note 2: These guidelines may not apply in all situations. Electromagnetic propagation is affected by absorption and reflection from structures, objects, and people.

8

Troubleshooting

This chapter provides helpful information in troubleshooting the Spot Vital Signs LXi.

Error Codes

The following tables of error codes provide a quick reference of the descriptions and probable causes of error codes.

Table 1. Informational Error Codes

Internal Event Log Code Number	Displayed Device Code	Internal Event Log Description	Corrective Action
_n/a		Copyright notice displayed on powers up splash screen.	
_n/a		Message displays when the user attempts to start another print while a print job is currently printing.	Printing is already in progress
_n/a		Clear current reading.	
_n/a		Erase all readings.	
_n/a		Information screen telling the user how to operate the location identifier edit menu in Configuration Mode.	Use the navigation keys to edit characters and the SELECT key to stop editing.
_n/a		Message displays when Mod F cannot perform a STEP NIBP measurement and switches to normal method.	Restrict patient movement.
_n/a		Message displays when in MEM mode and there are no readings to display.	
_n/a		External devices configuration menu message when the user tries to exit the menu having enabling the information system, but not that Patient ID.	User must enable the Patient ID if using the information system.
_n/a		Message displays below txtPIDMsgB.	User must press SELECT and correct the problem.
_n/a		Information displays when the user enables device in external devices configuration menu.	User must connect the Spot Vital Signs LXi to an external device.
_n/a		Message displays below txtPIDMsgA	User must press SELECT when completed.
_n/a		Line displays below error/information message if the user can clear the error/condition.	User must press ACCEPT to clear.

Table 1. Informational Error Codes

Internal Event Log Code Number	Displayed Device Code	Internal Event Log Description	Corrective Action
_n/a			User decides whether to reset everything back go factory default values.
_n/a		Error condition occurs causing the unit to automatically shut down. The user cannot clear this message.	Spot Vital Signs LXi will shut down in 1 minute.
_n/a			User confirms to start printing.

Table 2. Blood Pressure Error Codes

Internal Event Log Code Number	Displayed Device Code	Internal Event Log Description	Corrective Action
10	C01	User abort.	
11	C03	Inflation too quick.	Check tubing and connections.
12	E10	Overpressure	Check patient.
13	C04	Major air leak.	Excessive inflation time; check for air leaks.
14	C05	Excessive arm movement	Excessive noise, check cuff placement; restrict patient movement.
15	C07	Auto cycle skipped, system busy.	Device will power down.
16	C07	Auto cycle skipped, NIBP reached too soon.	Device will power down.
17	C02	Auto zero failure.	Auto zero failure; check air obstruction; limit patient movement.
18	C04	Could not reach target pressure.	Excessive inflation time; check for air leaks.
19	E20	Missed A/D sample.	General internal malfunction. Call Technical Support.
20	E20	A/D timeout failure.	General internal malfunction. Call Technical Support.
21		NIPB NOT AVAILABLE.	Correct probe tip conditions. If problem persists, replace probe. If problem still persists, replace module.
22	E11	Malfunction	User should try another cycle. If problem persists, replace probe.
23	C06	Reinflation needed.	Measurement was outside of device's measurement range.
24	C05	Cycle took too long.	Check cuff placement; restrict patient movement.
25	C12	Ambient temp out of range.	Check internal temperature at probe well. Verify ambient temperature does not exceed operating specification.
26	C13	Battery failure	Battery failure; use wall transformer.

Table 2. Blood Pressure Error Codes

Internal Event Log Code Number	Displayed Device Code	Internal Event Log Description	Corrective Action
27	E11	> 10mm residual pressure > minutes.	Verify that the supply voltage is within specification.
28	E11	>15mm residual pressure >3 mins.	Verify that the supply voltage is within specification.
29	C02	Couldn't bleed pressure < 9 mmHg	Auto zero failure, check tubing for kinks and connection integrity, limit patient movement.
32		Thermistor pulled away from the tip or heater broken.	Try another predict cycle. If the problem persists, replace probe.
33		Probe not responsive. Probe not characterized/calibrated.	Replace probe.
34		Probe not characterized/calibrated.	Replace probe.
41	C06	Low inflation; first step had largest value, first step's value > systolic value.	Measurement was outside of Spot Vital Signs LXi measurement range.
42	C06	Dump too soon; last step had largest value, next to last step's value > diastolic value; will not normally occur in auto-dump mode.	Check connections; restrict patient movement.
43	C05	Step too big systolic; difference in pressure between step above and step below systolic is too great.	Excessive noise; check cuff placement and limit movement.
44	C05	Step too big diastolic; difference in pressure between step above and step below diastolic is too great.	Excessive noise; check cuff placement and limit movement.
45	C05	Range error: calculated BP is outside of measurement range.	Excessive noise; check cuff placement and limit movement.
46	C05	Pressure reverse systolic; pressure of step above systolic is lower than pressure of step below systolic.	Excessive noise; check cuff placement and limit movement.
47	C05	Pressure reverse diastolic; pressure of step above systolic is lower than pressure of step below diastolic.	Excessive noise; check cuff placement and limit movement.
48	C05	Step too big MAP; difference in pressure between adjacent steps near MAP is too great.	Excessive noise; check cuff placement and limit movement.
49	C05	Too few steps; less than 5 steps	Excessive noise; check cuff placement and limit movement.
50	C05	Bad value diastolic; value of step below diastolic and step below that step are not consistent.	Excessive noise; check cuff placement and limit movement.
51	C05	Value reverse systolic; value of step above systolic is greater than value of step below systolic.	Excessive noise; check cuff placement and limit movement.
52	C05	Value reverse diastolic; value of step above systolic is greater than value of step below diastolic.	Excessive noise; check cuff placement and limit movement.

Table 2. Blood Pressure Error Codes

Internal Event Log Code Number	Displayed Device Code	Internal Event Log Description	Corrective Action
53	C05	No info - can't be produced by Mod F if they don't exist in the code.	Excessive noise; check cuff placement and limit movement.
54	C05	No info - can't be produced by Mod F if they don't exist in the code.	Excessive noise; check cuff placement and limit movement.
55	C05	No info - can't be produced by Mod F if they don't exist in the code.	Excessive noise; check cuff placement and limit movement.
56	C05	Out of memory; deflation contains too many steps. SW sets allowable limit of steps that can be stored and used for BP determination for a given cycle.	Excessive noise; check cuff placement and limit movement.
57	C05	Retarget error; cycle tried to retarget too many times. Only one allowed retarget allowed per cycle.	Excessive noise; check cuff placement and limit movement.
58	C05	Repump error: Tried to repump too many times. Limit is set to 3 repumps. This can occur on a cycle with bad signal to noise ratio or if a subject's pulses are so small that pulses above the diastolic ratio are not detectable with the lowest allowed thread threshold.	Excessive noise; check cuff placement and limit movement.
59	C05	Systolic curve fit error; the steps on the systolic side of the envelope could not be curve fit. Causes include: too few or too many steps sent to curve fit routine; math error in curve fit routine.	Excessive noise; check cuff placement and limit movement.
60	C05	Diastolic curve fit error; the steps on the systolic side of the envelope could not be curve fit. Causes include: too few or too many steps sent to curve fit routine; math error in curve fit routine.	Excessive noise; check cuff placement and limit movement.
61	C05	Systolic slope error; slope of curve fit of systolic points has a slope out of range. Can occur with bad cuff fit, rapidly changing BP etc.	Excessive noise; check cuff placement and limit movement.
62	C05	Diastolic slope error; slope of curve fit of diastolic points has a slope out of range. Can occur with bad cuff fit, rapidly changing BP etc.	Excessive noise; check cuff placement and limit movement.
63	C05	Systolic extrapolation error; the systolic pressure that is represented by the systolic ratio is outside of the data sent to the curve fit routine.	Excessive noise; check cuff placement and limit movement.
64	C05	Diastolic extrapolation error; the systolic pressure that is represented by the diastolic ratio is outside of the data sent to the curve fit routine.	Excessive noise; check cuff placement and limit movement.
65	C05	Peak range error; the height of the peak of the envelope is outside normal limits.	Excessive noise; check cuff placement and limit movement.
66	C05	Reinflation too late.	Excessive noise; check cuff placement and limit movement.

Table 2. Blood Pressure Error Codes

Internal Event Log Code Number	Displayed Device Code	Internal Event Log Description	Corrective Action
67	C06	High heart rate.	Unable to determine blood pressure; pulse rate may be out-of-range.
68	Err	Too many reinflates.	Restrict patient movement.
69	C06	Problem reading the module's EEPROM or saving to the module's EEPROM.	Verify that the supply voltage is correct. Try to make changes. If problem persists, replace module.
70	C06	Problem reading the probe's EEPROM.	Verify that the supply voltage is correct. Try to make changes.
78	C06	The probe non-volatile error log memory error detection mechanism detected error.	Measurement was outside of device's measurement range.
79	C06	The module's non-volatile error log memory error detecting mechanism detected an error.	Measurement was outside of device's measurement range.
5600	Err	Invalid ModF algorithm.	
5601	Err	Invalid ModF init code.	
5602	Err	Invalid ModF PMode.	
5603	Err	Invalid ModF target pressure.	
5604	Err	Invalid ModF configuration.	

Table 3. POST Error Codes

Internal Event Log Code Number	Displayed Device Code	Internal Event Log Description	Corrective Action
80	E30	FPROM checksum error.	General internal malfunction; contact Technical Support.
81	E31	RAM test failure.	General internal malfunction; contact Technical Support.
82	E32	Factory EEprom checksum error.	General internal malfunction; contact Technical Support.
83	E33	User EEprom checksum error.	General internal malfunction; contact Technical Support.
84	E34	A/D converter failure.	General internal malfunction; contact Technical Support.
85	E35	SpO2 module failure.	General internal malfunction; contact Technical Support.
86	E36	Diatek module failure	General internal malfunction; contact Technical Support.
87	E37	Printer problem.	General internal malfunction; contact Technical Support.
88	E38	Real time clock failure.	Date and time not set; see "Set the Date and Time Configurations" in the Directions for Use.

Table 3. POST Error Codes

Internal Event Log Code Number	Displayed Device Code	Internal Event Log Description	Corrective Action
89	E39	No calibration signature.	General internal malfunction; contact Technical Support.
90	E40	Bad NIBP calibration record.	General internal malfunction; contact Technical Support.
91	E41	Stepper valve bad.	General internal malfunction; contact Technical Support.
92	E42	8bit substitute for 16bit errors.	Internal communications error. Disconnect the battery and wait 5 minutes. Reconnect the battery, and then see "Set the Date and Time Configurations" in the Directions for Use.
93	E43	Error log checksum error.	General internal malfunction; contact Technical Support.
94	Err-E44	POST que full.	General internal malfunction; contact Technical Support.
95	E44 E45	POST que full.	General internal malfunction; contact Technical Support.

Table 4. SureTemp Plus Temperature Error Codes

Internal Event Log Code Number	Displayed Device Code	Internal Event Log Description	Corrective Action
121	E0.4	Probe is over temperature (112° F / 44.4° C).	Correct probe tip conditions. If problem persists, replace probe.
122	E0.1	Excessive heater energy.	Try another predict cycle. If problem persists, replace probe.
123	23	Host interface error.	Try another predict cycle. If problem persists, replace probe.
124	A^!	Device outside operating temperature range.	Decrease ambient temperature.
125	Av!	Device outside operating temperature range.	Increase ambient temperature.
126	26	Invalid SureTemp algorithm.	Try another predict cycle. If problem persists, replace probe.
127	b^	Battery voltage over the algorithm's maximum value.	Contact Technical Support.
128	bv	Battery voltage under the algorithm's minimum value.	Contact Technical Support.
129	29	Battery voltage not set.	Try another predict cycle. If problem persists, replace probe.
130	30	Prediction algorithm not set.	Try another predict cycle. If problem persists, replace probe.
131	31	Ambient temperature not set.	Try another predict cycle. If problem persists, replace probe.

Table 4. SureTemp Plus Temperature Error Codes

Internal Event Log Code Number	Displayed Device Code	Internal Event Log Description	Corrective Action
132	E0.5	No probe temperature rise.	Try another predict cycle. If problem persists, replace probe.
133	E0.9	Probe EEPROM is uninitialized. Bad probe gain.	Calibrate probe or replace probe.
134	E0.9	Probe EEPROM is uninitialized. Bad probe response value.	Calibrate probe or replace probe.
145	E0.2	A/D measurement overrun - pulse too long.	Patient or environmental temperature conditions may be too low. Verify conditions at 80° F and 50° F respectively. If conditions are valid and problem persists, replace probe. If problem persists, replace the SureTemp Plus Thermometer module.
146	E0.2	A/D Measurement underrun - pulse too short.	Patient or environmental temperature conditions may be too high. Verify conditions at 110° F and 104° F respectively. If conditions are valid and problem persists, replace probe. If problem persists, replace the SureTemp Plus Thermometer module.
147	E4.1	A/D measurement overrun - RCAL pulse too long.	If problem persists, replace the SureTemp Plus Thermometer module.
148	E4.1	A/D measurement underrun - RCAL pulse too short.	If problem persists, replace the SureTemp Plus Thermometer module.
149	E4.0	A/D measurement overrun - PTB pulse too long.	If problem persists, replace the SureTemp Plus Thermometer module.
150	E4.0	A/D measurement underrun - PTB pulse too short.	If problem persists, replace the SureTemp Plus Thermometer module.
151	E0.2	A/D measurement overrun - timeout.	If problem persists, replace the SureTemp Plus Thermometer module.
152	E0.9	Probe EEPROM is uninitialized.	Bad probe A/D calibration.
159	bv	Displayed when battery voltage is too low.	
160	b^	Displayed when battery voltage is too high.	
161	E4.2	Reference power supply malfunction.	If problem persists, replace the SureTemp Plus Thermometer module.
162	E4.8	Device not calibrated.	Calibrate device.
163	E4.9	Missing probe well - cycle will not start.	Insert probe well.
165	E4.3	Device EEPROM save failure.	Verify that the batteries are fresh. Try to make changes again. If problem persists, replace the SureTemp Plus Thermometer module.
166	E0.8	EEPROM CRC Failure. (CONFIG_TRANSFER_FAILURE)	Verify that the batteries are fresh. Try again, if problem persists, replace the component that is indicated.

Table 4. SureTemp Plus Temperature Error Codes

Internal Event Log Code Number	Displayed Device Code	Internal Event Log Description	Corrective Action
167	E4.4	Device EEPROM read/save failure. (CONFIG_START_FAILURE)	Verify that the batteries are fresh. Try to make changes again. If problem persists, replace the SureTemp Plus Thermometer module.
168	E4.5	Device EEPROM read/save failure. (CONFIG_SLAVE_ACK_FAILURE)	Verify that the batteries are fresh. Try to make changes again. If problem persists, replace the SureTemp Plus Thermometer module.
169	E4.6	Device EEPROM read/save failure. (CONFIG_MASTER_ACK_FAILURE)	Verify that the batteries are fresh. Try to make changes again. If problem persists, replace device.
170	E0.6	Probe EEPROM read failure. (CONFIG_NULL_CHAR_FAILURE)	Verify that the batteries are fresh. Try to make changes again. If problem persists, replace the SureTemp Plus Thermometer module.
171	71	Device EEPROM access failure. (CONFIG_ACQUIRE_FAILURE)	Try another predict cycle. If problem persists, replace probe.
172	72	Device EEPROM access failure. (CONFIG_RELEASE_FAILURE)	Try another predict cycle. If problem persists, replace probe.
173	73	Device EEPROM access failure. (CONFIG_INVALID_PTR_FAILURE)	Try another predict cycle. If problem persists, replace probe.
174	E4.7	Device EEPROM initialization failure. (CONFIG_INITIALIZE_FAILURE)	If problem persists, replace the SureTemp Plus Thermometer module.
175	E0.7	Probe EEPROM is un-initialized. (CONFIG_UNINITIALIZED_PROBE)	Verify that the batteries are fresh. If problem persists, replace probe.
180	E5.0	Heater stuck on. (ERROR_HEATER_ON)	If problem persists, replace the SureTemp Plus Thermometer module.
181	E5.0	Heater stuck off. (ERROR_HEATER_OFF)	If problem persists, replace the SureTemp Plus Thermometer module.
182	E5.0	Heater on when should be off. (ERROR_HEATER_VOLTAGE_HIGH_Q)	If problem persists, replace the SureTemp Plus Thermometer module.
183	E5.0	Heater on when should be off. (ERROR_HEATER_VOLTAGE_Q_HIGH_IMPEDANCE)	If problem persists, replace the SureTemp Plus Thermometer module.
184	E5.0	Heater is off when it should be on. (ERROR_HEATER_VOLTAGE_LOW)	If problem persists, replace the SureTemp Plus Thermometer module.
185	E5.2	Heater hardware failsafe failure. (ERROR_HEATER_FAILSAFE)	If problem persists, contact Technical Support.

Table 5. SpO₂ Error Codes

Internal Event Log Code Number	Displayed Device Code	Internal Event Log Description	Corrective Action
1		Missing or disconnected sensor.	Adjust or replace sensor.
3	--	No pulse from sensor.	Adjust or replace sensor.

Table 5. SpO₂ Error Codes

Internal Event Log Code Number	Displayed Device Code	Internal Event Log Description	Corrective Action
4	E7	Communications failure.	Retake reading; contact Technical Support.
5		8-second timeout interval	
6	C8	Defective or bad SpO ₂ sensor.	Replace sensor.
	C9	SpO ₂ time limit exceeded.	Remove sensor from patient.

Table 6. Comms Errors

Internal Event Log Code Number	Displayed Device Code	Internal Event Log Description	Corrective Action
1000	Err	Invalid Operation in this Context.	Internal error, contact Technical Support.
1001	Err	Auto zero in progress.	Internal error, contact Technical Support.
1002	Err	Bad checksum.	Internal error, contact Technical Support.
1003	Err	Unimplemented command.	Internal error, contact Technical Support.
1004	Err	Buffer Overflow.	Internal error, contact Technical Support.
1005	Err	Overrun error.	Internal error, contact Technical Support.
1006	Err	Wrong data count.	Internal error, contact Technical Support.
1007	Err	FEPROM erase error.	Internal error, contact Technical Support.
1008	Err	FEPROM programming error	Internal error, contact Technical Support.
1009	Err	Bad Motorola record.	Internal error, contact Technical Support.
1010	Err	A/D channel locked.	Internal error, contact Technical Support.
1011	Err	RTC not present.	Internal error, contact Technical Support.
1012	Err	Attempt to reference nonexistent cycle.	Internal error, contact Technical Support.
1013	Err	Data range error.	Internal error, contact Technical Support.
1014	Err	Alarm pair range error.	Internal error, contact Technical Support.
1015	Err	No POST error to clear.	Internal error, contact Technical Support.
1016	Err	Can't clear this POST error.	Internal error, contact Technical Support.
1017	Err	Command not command type.	Internal error, contact Technical Support.
1018	Err	NAK from ST3800 protocol.	Internal error, contact Technical Support.
1019	Err	No wireless link.	Internal error, contact Technical Support.

Table 7. Comms Host Errors

Internal Event Log Code Number	Displayed Device Code	Internal Event Log Description	Corrective Action
2001	Err	Timeout.	Internal error, contact Technical Support.
2002	Err	Incorrect response header.	Internal error, contact Technical Support.
2003	Err	Incorrect response checksum.	Internal error, contact Technical Support.
2004	Err	Too much received data.	Internal error, contact Technical Support.
2005	Err	User cancelled.	Internal error, contact Technical Support.
2006	Err	User paused.	Internal error, contact Technical Support.

Table 8. Printer Errors

Internal Event Log Code Number	Displayed Device Code	Internal Event Log Description	Corrective Action
5400	Err	Problem with the printer	Check all options; if problem persists, contact Technical Support.
5401	Err	Printer is not responding.	
5402	Err	Displayed when print started and printer is out of paper.	Printer head will not shut all the way or too much paper.
5403	Err	Displayed when printing started and print head is not closed in place.	Add paper.

Table 9. Spot Vital Signs LXi Errors

Internal Event Log Code Number	Displayed Device Code	Internal Event Log Description	Corrective Action
5500		Unknown error code.	
5501	Err	Displayed when battery is too low for unit to continue operating.	Charge battery; use wall transformer.
5502	Err	Key stuck error causing the unit to be automatically shut down.	

Table 10. 802.11 b Radio Errors

LED	LED Color	Function
Power	Off	Bridge is not receiving power.
	Red	Bridge failed its Power On Self Test (POST) and is not configured for wireless communication.
	Amber	Bridge passed its POST but is not configured for wireless communication.
	Green	Bridge passed its POST and is configured for wireless communication.
Link	Off	Bridge is not receiving power.
	Red	Bridge is searching for an Access Point.
	Green	Wireless network and MAC have associated with an Access Point.
Comm	Off	No power or no wireless TCP session is established and no physical serial connection is detected.
	Red	No wireless TCP session is established; a physical connection is detected.
	Blinking Red	A physical serial connection was detected and there is serial traffic present on that connection, but no wireless TCP session is established.
	Amber	A wireless TCP connection is established but no physical serial connection is detected (i.e. no serial cable is attached to the Bridge).
	Blinking Green	A wireless TCP session is established, a physical serial connection is detected, and the Bridge is transmitting or receiving data across the wired serial port.
	Green	A wireless TCP session is established, a physical serial connection is detected, but there is no active data movement across the wired serial port.

NOTE:The 802.11a/b/g radio has no functional LED displays.

Radio Test

Refer to Manufacturer's Directions for Use.

Service Work Checklist

Spot Vital Signs

Model Number	Serial Number	BP Cycle Count	Technician	Date

Test	Test Data	Pass/Fail	Test Specification
Unit SW Version		N/A	N/A
SP02 SW Version		N/A	N/A
Thermometry SW Version		N/A	N/A
Unit Pressure @ 0 mmHg			0 mmHg (+/- 1 mmHg)
Unit Pressure @ 50 mmHg			50 mmHg (+/- 1 mmHg)
Unit Pressure @ 150 mmHg			150 mmHg (+/- 1.5 mmHg)
Unit Pressure @ 250 mmHg			+/- 2.0 mmHg
Test Voltage @ 5.5 V			+0.1 VDC
Current Test – Sleep State			< 0.5 A
Current Test – Patient DAQ			< 1.25 A
Current Test – Valve Pump			< 2.0 A
Noise Level			< 0.05 mmHg
Button Test			Pass/Fail
Interface Test			Pass/Fail
Leak Test			<= 6mmHg in 15 seconds
Dump Test			< 10 Seconds
Inflation Test			< 7 Seconds
Valve Control Test			Pass/Fail
Over Pressure Test			296 to 329 mmHg
SP02 Sensor - Masimo			81% +/- 3% 61bpm +/- 1bpm
SP02 Sensor - Nellcor			90% +/- 1% 60bpm +/- 1bpm
Temperature Calibration Suretemp Plus			96.8 +/- 0.2°F 105.8 +/- 0.2°F
Temperature Calibration Braun Pro 4000			96.8 +/- 0.2°F 105.8 +/- 0.2°F
Temperature Cal Key Suretemp Plus			97.3 +/- 0.2°F
Radio Ping Test	Pass or Fail		Pass

Spot LXi Radio Configuration Tool

This CD configures the Spot Vital Signs LXi Radio to a local network. See the Welch Allyn Spot LXi Radio Configuration Procedure (80012309) for further information.

9

Supplies and Accessories

Blood Pressure

Table 1. Reusable Blood Pressure Cuffs (1 per pack)

REF	Size	REF	Size
4500-01	Child	4500-03	Large Adult
4500-02	Adult	4500-04	Thigh

Table 2. Reusable Blood Pressure Cuffs (1 per pack)

REF	Size	REF	Size
REUSE-07-2MQ	Infant	REUSE-11-2MQ	Adult
REUSE-08-2MQ	Small Child	REUSE-12-2MQ	Large Adult
REUSE-09-2MQ	Child	REUSE-13-2MQ	Thigh
REUSE-10-2MQ	Small Adult		

Table 3. Disposable Blood Pressure Cuffs (5 per box)

REF	Size	REF	Size
SOFT-07-2MQ	Infant	SOFT-11-2MQ	Adult
SOFT-08-2MQ	Small Child	SOFT-12-2MQ	Large Adult
SOFT-09-2MQ	Child	SOFT-13-2MQ	Thigh
SOFT-10-2MQ	Small Adult		

Table 4. Miscellaneous Supplies and Accessories

REF	Description	REF	Description
4500-30	Blood Pressure Hose (5ft/1.5M)	4500-31	Blood Pressure Hose (10ft/3M)
4500-32	Blood Pressure Hose (8ft/2.4M)		

Temperature

Table 5. SureTemp Plus

REF	Description
02895-000	SureTemp Plus Oral Probe and Well (9 feet/2.7M)
02895-100	SureTemp Plus Rectal Probe and Well (9 feet/2.7M)
02894-0000	SureTemp Plus Oral Well
02894-1000	SureTemp Plus Rectal Well
06138-000	SureTemp Plus Temperature Calibration Key
01802-110	9600 Plus Calibration Tester
05031-101	Disposable SureTemp Plus Probe Covers (1,000 covers, packaged 25/box)
20500-025M	Probe Cover-Box 25
400194	Assy, Suretemp Plus Components, Spot Vital Signs LXi
400195	PCA, Suretemp Plus OEM without EDAC Calibrated
400196	PCA, EDAC, Spot Vital signs LXi

Table 6. Braun ThermoScan PRO 4000

REF	Description
04000-200	Braun ThermoScan PRO 4000 Thermometer (for North America, South America, and Asia Pacific)
04000-600	Braun ThermoScan PRO 4000 Thermometer (for Europe, Middle East, and Africa)
05075-800	Braun ThermoScan PRO 4000 Disposable Probe Covers (Case of 800 covers for North America, South America, and Asia Pacific)
04000-800	Braun ThermoScan PRO 4000 Disposable Probe Covers (Case of 800 covers for Europe, Middle East, and Africa)
01802-110	9600 Plus Calibration Tester
53020-0000	Braun ThermoScan PRO 4000 Rechargeable Battery Pack
4500-53	Braun Unlocking Key
4500-54	Repair-Braun with rechargeable batteries

Pulse Oximetry

Masimo Accessories

Table 7. Adhesive Sensors: Single-Patient Use

Catalog #	Description	Weight Range	Quantity
NEO-WRAP-RP	Replacement Wrap Neo Adhesive		
LNCS-INF-3	Disposable Adhesive Finger Sensor-Infant		
INF-WRAP-RP	Replacement Wrap Infant Adhesive		
YI-AD	Multisite Adhesive Wrap AD/PED/NEO, YI Sensor		
YI-FM	Multisite Foam Wrap AD/PED/NEO, YI Sensor		
LNCS-YI	Multisite Reusable Sensor		
LNCS-TC-I	Reusable Ear Sensor		
LNCS-NEO-L-3	Disposable Adhesive Finger Sensor- NEO/Adult		
LNCS-ADTX	Adhesive Finger Sensor - Adult (20 per case)	>30 kg	LNCS-ADTX
LNCS-PDTX	Adhesive Finger Sensor - Pediatric (20 per case)	10 to 50 kg	LNCS-PDTX
LNCS INF-L	Adhesive Finger Sensor - Infant (20 per case)	3 to 20 kg	LNCS INF-L
LNOP-ADT	Adult sensor	>66 lbs (30 kg)	20
LNOP-PDT	Pediatric sensor	22 to 110 lbs (10 to 50 kg)	20
LNOP-NEO	Neonatal sensor	<22 lbs (10 kg)	20
LNOP-NEOPT	SofTouch neonatal preterm sensor	<2.2 lbs (1 kg)	20

Table 8. Reusable Sensor

Catalog #	Description	Weight Range	Quantity
LNCS-TC-I	Reusable Ear Sensor		
LNCS-YI	Multisite Reusable Sensor		
LNCS-DCI	Finger sensor - adult	>66 lbs (30 kg)	1
LNCS-DCIP	Finger sensor - pediatric	10 to 50 kg	1
LNOP-DCI	Finger clip probe - adult	>66 lbs (30 kg)	1
LNOP-DCIP	Finger clip probe - pediatric	10 to 50 kg	1

Table 9. Sensor Cables

Catalog #	Description	Weight Range	Quantity
LNC-4-WA	4-foot cable with DB-9 connector for LNCS	NA	1
LNC-10-WA	10-foot cable with DB-9 connector for LNCS	NA	1
PC-04	4-foot cable with sensor connector	NA	1

Table 9. Sensor Cables

Catalog #	Description	Weight Range	Quantity
PC-08	8-foot cable with sensor connector	NA	1
PC-12	12-foot cable with sensor connector	NA	1

Nellcor Accessories

Table 10. OxiMax Adhesive Sensors: Single-Patient Use

Catalog #	Description	Weight Range	Quantity
MAX-AI	MAX-A Adhesive Sensor, adult	>66 lbs (30 kg)	Case of 24
MAX-PI	MAX-P Adhesive Sensor, pediatric	22 to 110 lbs (10 to 50 kg)	Case of 24
MAX-II	MAX-I Adhesive Sensor, infant	6.5 to 44 lbs (3 to 20 kg)	Case of 24
MAX-RI	MAX-R Adhesive Sensor, adult nasal	>110 lbs (50 kg)	Case of 24

Table 11. OxiMax OxiCliq[®] Sensors: Reusable Cable with Adhesive Sensor Bandage

Catalog #	Description	Weight Range	Quantity
OC-3	OxiCliq Sensor Cable (3 ft / 91cm)	N/A	1
OXCCLIQ-PI	OxiCliq P, pediatric	22 to 110 lbs (10 to 50 kg)	Case of 24

Table 12. OxiMax Reusable Sensors

Catalog #	Description	Weight Range	Quantity
DS-100A	Durasensor [®] DS-100A finger-clip sensor, adult	>88 lbs (40 kg)	1
OXI-A/N	Oxiband [®] OXI-A/N, adult/neonatal	< 6.5 lbs or > 88 lbs (<3 kg or >40 kg)	1
OXI-P/I	Oxiband OXI-P/I, pediatric/infant	6.5 lbs to 88 lbs (3 to 40 kg)	1
D-YS	Dura-Y [®] D-YS, multisite sensor	>2.2 lbs (1 kg)	1
D-YSE	D-YSE ear clip for Dura-Y sensor	>66 lbs (30 kg)	1
D-YSPD	PediCheck [™] D-YSPD pediatric spot-check sensor	6.5lbs to 88 lbs (3 to 40 kg)	1

Table 13. OxiMax Sensor Cables

Catalog #	Description	Weight Range	Quantity
DOC-10	DOC-10 (10 ft/3M)	N/A	1

Miscellaneous

REF	Description
4500-60	Mobile Stand, Spot Vital Signs LXi
4500-62	Wall Mount, Spot Vital Signs LXi
4500-84	Lead Acid Battery
705310	Directions for Use, Spot Vital Signs LXi English
705298	Quick Reference Card
4500-11	Child Inf. Bag, 2 Tube Monitor
4500-12	Adult Bag, 2 Tube Monitor
4500-13	Large Adult Inf. Bag, 2 Tube Monitor
4500-14	Thigh Inf. Bag, 2 Tube Monitor
4500-75	Kit, Desk Plate, Spot Vital Signs LXi
4500-89	Service Manual, Spot Vital Signs LXi
4500-150E	In-Service CD, Spot Vital Signs LXi
4500-100	Carrying Case, Spot Vital Signs LXi
4500-101A	AC Power Transformer (desktop transformer, line cord not included)
4500-200	Cuffkit, Child, Adult, Thigh, 2T Cuff & Bag
4500-202	Cuffkit, Small Child, Child, Small Adult 2T
4500-400	Line Cord (United States/Canadian/Japanese version)
4500-402	Line Cord (European version)
4500-404	Line Cord (United Kingdom version)
4500-406	Line Cord (Australian version)
4500-408	Line Cord (South African version)
4500-450	Transformer Mount, Spot Vital Signs LXi
4500-500	Kit, Printer, Spot Vital Signs LXi
4500-505	Printer Rechargeable Replacement Battery
4500-510	Printer Paper (10 rolls)
4500-520	Label Paper (10 rolls) and Cleaning Kit
4500-900	Kit, Dev Conn SDK Developers
4500-905	Repair Tool Software CD Kit
4500-906	Spot Vital Signs LXi Configuration CD
4500-907	Spot Vital Signs LXi Firmware Loader CD
4500-915	Image Team 4600 2D Bar Code Scanner Kit
4500-920	802.11b (DEPAC) Radio Kit
4500-921	Radio Directions for Use
4500-922	802.11 a/b/g Spot Vital Signs LXi Radio Kit
4500-923	Spot Vital Signs LXi a/b/g Radio Directions for Use

REF	Description
4500-925	USB 2.0 Cable for Wired Connectivity
4500-926	Cable for Wired Connectivity, Keyspan (USB to serial adapter)
4500-927	Spot Vital Signs LXi USB/serial Cable Kit
5200-08	Calibration T Fitting

Service Contracts

See the Welch Allyn Partners In Care™ web site (<http://www.welchallyn.com/promotions/services/default.htm>) for a description of the different service contracts offered.

10

Field Replaceable Units

The following list identifies the available FRUs for Spot Vital Signs LXi. To order an FRU, contact Welch Allyn Technical Support.

Table 1. Spot Vital Signs LXi Base Components

Component Number	Object Description
400163	ASSY, POWER HARNESS, Spot Vital Signs LXi
400170	ASSY, PUMP HARNESS
403912	PCA, MAIN, Spot Vital Signs LXi
400200	BASE UNIT, SURETEMP, NELLCOR - Spot Vital Signs LXi
400203	BASE UNIT COMPONENTS, Spot Vital Signs LXi
400207	LANGUAGE COMPONENTS, ENG, Spot Vital Signs LXi
400387	PBCA BP OEM, (MOD F)
4500-901	Spot Vital Signs LXi Pump and Pump Tubing Kit
4500-902	Spot Vital Signs LXi Pump Tubing Kit
4500-84	Lead Acid Battery
4500-101A	AC Power Transformer
400720	ASSY, BALLAST HARNESS, Spot Vital Signs LXi
400732	ASSY, BATTERY, Spot Vital Signs LXi
401082	Assy, Bezel and Window, Spot Vital Signs LXi
401250	Assy, Fan Unit Cooling
421051-12	TUBING, 1/8 X 1/4 X 2.50
421051-9	TUBING, 1/8 X 1/4 X 0.95
59P586	FOOT, RUBBER
620028-E	LABEL, CAUTION
620217	FITTING, "T", 1/8 X 1/16X 1/8
700101	HSG, HANDLE, LXi
700102	HSG, HANDLE INSERT, LXi Ultra
700103	HSG, REAR, LXi
700105	HSG, BATT DOOR, Spot Vital Signs LXi
700110	BUMPER, LCD, Spot Vital Signs LXi
707237	SWITCH ARRAY, Spot Vital Signs LXi-New
700119	INVERTER, LCD

Table 1. Spot Vital Signs LXi Base Components

705653	HOUSING, FRONT, Spot Vital Signs LXi
704423	HSG, PANEL, SPO2-BLANK, Spot Vital Signs LXi
4500-89	SERVICE MANUAL, Spot Vital Signs LXi
401427	LABEL, ICON ID, Spot Vital Signs LXi
700863	CBL,FLX, 1/2mm,15POS,1.0"
704375	FLEX, MAIN, Spot Vital Signs LXi
701040	FITTING, PLASTIC L, 1/16 X 1/16
701502	Valve,Pneumatic,6PSI,5V,TH
703077	STANDOFF, PCB, BROACHING, #4 X .500 LG
703118	BATTERY CLIP, AA, SINGLE
703354	DISPLAY, LCD, 320X240, BLITE, MONO, 3.3V, 5.7"
703355	FILTER, AIR, 1/8 BARBS
705284	Spot Vital Signs LXi Warranty Card English
705298	QRC, Spot Vital Signs LXi English
705310	DFU, Spot Vital Signs LXi English
703842	TUBING, SILICONE, .063ID X .125OD X 5.50
700847	TUBING, SILICONE, .125IDx.250Dx1.75LG
421023-501	ASSEMBLY, SPOT PUMP REPAIR
4500-500	KIT, PRINTER, SPOT ULTRA (LXi)
4500-501	Spot LXi PRINTER UPGRADE KIT
713703	SPOT LXi PRINTER POWER SUPPLY

Table 2. SureTemp Plus Components

Component Number	Object Description
02692-100	PROBE ASSY,ORAL 9FT
02894-0000	ASSY,PRB WLL,BLUE,OEM,M690_692
400194	ASSY, SURETEMP+, COMPONENTS, Spot Vital Signs LXi
400195	PCA, SURETEMP+, OEM W/O EDAC, CALIBRATED
400196	PCA, EDAC, Spot Vital Signs LXi
700111	HOUSING, THERM OEM POD, Spot Vital Signs LXi
700112	PLATE, POD MOUNTING, Spot Vital Signs LXi
700858	CBL,FLX,1MM,6POS
700859	CBL,FLX,1MM,8POS
70999-0000	LABEL,SURETEMP TECHNOLOGY
02692-100	PROBE ASSY,ORAL 9FT

Table 3. Braun ThermoScan PRO 4000 Components

Component Number	Object Description
400652	PCA, BRAUN INTERFACE, Spot Vital Signs LXi
400831	BRAUN COMPONENTS, Spot Vital Signs LXi
700112	PLATE, POD MOUNTING, Spot Vital Signs LXi
700820	HSG, BOTTOM, BRAUN POD, Spot Vital Signs LXi
700822	HSG, BRAUN POD, Spot Vital Signs LXi
704365	WINDOW, BRAUN POD, Spot Vital Signs LXi
700859	CBL,FLX,1MM,8POS
703161	SECURITY LOCK, BRAUN POD, Spot Vital Signs LXi
703162	LATCH, BRAUN POD, Spot Vital Signs LXi
703164	CONTACT, BRAUN POGO, Spot Vital Signs LXi
703165	SPRING, COMPRESSION
703192	COVER, BRAUN SECURITY, Spot Vital Signs LXi

Table 4. Masimo SpO₂ Components

Component Number	Object Description
008-0648-00	MASIMO LNCP-DCI ADULT REUSABLE SENSOR
008-0692-01	MASIMO - 8' INTERFACE CABLE
008-0960-00	MASIMO-LNCS-DCI ADULT REUSABLE SENSOR
008-1013-00	SPO2 CABLE, LNCS, MASIMO, MINI-D, 4', EXP
400192	PCA, MASIMO OEM, Spot Vital Signs LXi
400205	MASIMO SPO2 COMPONENTS, Spot Vital Signs LXi
400555	PCA, MASIMO ADAPTOR, Spot Vital Signs LXi
400610	ASSY, CABLE, FLAT FLEX, SPO2
704422	HSG, PANEL, SPO2-MASIMO, LXi
705651	HOUSING, FRONT MASIMO, Spot LXi
711350	MASIMO MS-11 SPO2, STD, SW V4.6.0.2
LNC-10-WA	MASIMO, 10' EXT CABLE, LNCS/DB-9
LNC-4-WA	MASIMO, 4' EXT CABLE, LNC/DB-9
LNCS-ADTX	MASIMO, LNCS-ADTX ADULT ADHSV, 20 CASE
LNCS-DCI	MASIMO, LNCS-DCI ADULT REUSABLE SENSOR
LNCS-DCIP	MASIMO, LNCS-DCIP PED REUSABLE SENSOR
LNCS-INF-L	MASIMO, LNCS-INF-L INFANT ADHSV, 20 CASE
LNCS-PDTX	MASIMO, LNCS-PDTX PED ADHSV, 20 CASE
LNOP-ADT	DISPOSABLE ADHESIVE FINGER CLIP PROBE-AD
LNOP-DCI	REUSABLE FINGER CLIP PROBE-ADULT
LNOP-DCIP	REUSABLE FINGER CLIP PROBE-PEDIATRIC
LNOP-NEO	DISP ADHESIVE FINGER CLIP PROBE-NEONATE

Table 4. Masimo SpO₂ Components

Component Number	Object Description
LNOP-NEOPT	DISPOSABLE FINGER SENSOR-NEONATE
LNOP-PDT	DISP ADHESIVE FINGER CLIP PROBE-PEDIATRIC
PC-04	4-FOOT CABLE W/ SENSOR CONN
PC-08	8-FOOT CABLE W/ SENSOR CONN
PC-12	12-FOOT CABLE W/ SENSOR CONN

Table 5. Nellcor SpO₂ Components

Component Number	Object Description
400183	PCA, NELCOR OEM, Spot Vital Signs LXi
400201	NELCOR SPO2 COMPONENTS, Spot Vital Signs LXi
400610	ASSY, CABLE, FLAT FLEX, SPO2
620377-1	"NELCOR WORKS HERE" LABEL
704421	HSG, PANEL, SPO2-NELCOR, LXi
704870	EVSPNELCOR NELL3 PULSE OXIMETRY
DOC-10	CABLE, SPO2 EXTENSION, NELCOR
DEC-4	EXTENSION CABLE 4 FT.
DS-100A	DURASENSOR,ADULT,DS-100A
D-YS	DURA-Y OXYGEN TRANSDER (1 sensor-40 wraps)
D-YSE	EAR CLIP (USE WITH DURA-Y SENSOR)
D-YSPD	PEDICHECK PEDIATRIC SPOT CHECK
MAX-AI	NELCOR OXIMAX ADULT SENSOR (SU CS/24)
MAX-II	NELCOR OXIMAX INFANT SENSOR (SU CS/24)
MAX-PI	NELCOR OXIMAX PED SENSOR (SU CS/24)
MAX-RI	NELCOR OXIMAX ADULT NASAL SEN (CS/24)
OC-3	NELCOR OXICLIQ SENSOR CABLE
OXI-A/N	NELCOR OXIBAND AD/NEO TRANSDUCER 1/50
OXICLIQ-PI	PEDIATRIC OXYGEN TRANSDUCER
OXI-P/I	NELCOR OXIBAND PED/INF TRANSDUCER 1/50

Table 6. Radio Components

Component Number	Object Description
708920	Spot Vital Signs LXi Wireless Radio (A/B/G)
703380	Spot Vital Signs LXi Wireless Radio Mounting Bracket
704622	Spot Vital Signs LXi Wireless Radio Mounting Instructions
4500-915	Image Team 4600 2D Barcode Scanner Kit
703878	Null Modem 9-Pin M/F 4-40
4500-920	Kit, Spot Vital Signs LXi 802.11b Radio
4500-921	802.11 b radio Directions for Use
4500-922	Kit, Wireless Spot Vital Signs LXi 802.11a/b/g Radio
4500-923	802.11a/b/g Radio Directions for Use
4500-905	Repair Tool CD, Spot Vital Signs LXi
4500-906	Spot Vital Signs LXi Configuration CD
4500-907	Spot Vital Signs LXi Firmware Loader CD
4500-925	Cable for wired connectivity
4500-926	Cable for wired connectivity, Keyspan (USB to serial adapter)
4500-927	USB 2.0/serial cable kit
404684	Spot Vital Signs LXi Firmware Upgrade CD in case
404685	Spot Vital Signs LXi Radio Configuration CD in case

11

Disassembly and Repair

This chapter provides the instructions for removing and replacing serviceable modules in the Spot Vital Signs LXi.

In general, re-assembly procedures are the reverse order of the disassembly procedures.



WARNING Electric shock hazard. There are no user-serviceable parts inside Spot Vital Signs LXi other than battery replacement (see “Battery Replacement” on page 46). Only an individual specifically trained and approved for the repair and/or verification of this specific Welch Allyn product may perform maintenance procedures specifically described in this manual. For service, refer the device to an Authorized Service Center.

Note Always disconnect the sealed lead-acid battery in the Spot Vital Signs LXi before performing any repair function.

Tool list

Description	Part Number	Qty	Source
Blood Pressure Test Volume Repair Fixture	407672	1	Welch Allyn
Spot LXi Service Tool Software	4500-905	1	Welch Allyn
Service Manual, Spot Vital Signs LXi	704432	1	Welch Allyn
Spot Vital Signs LXi Directions for Use	705310	1	Welch Allyn
802.11b Radio	4500-920	1	Welch Allyn
802.11b Radio Directions for Use	4500-921	1	Welch Allyn
802.11a/b/g Radio	4500-922	1	Welch Allyn
802.11a/b/g Radio Directions for Use	4500-923	1	Welch Allyn
Tester, Calibration, 9600 Plus	01802-110	1	Welch Allyn
SureTemp Oral Probe	02895-000	1	Welch Allyn
Blood Pressure Y-Tube, No Fittings 1/8 Tube	5082-183	1	Welch Allyn
Welch Allyn Cuff	Soft-11-2MQ	1	Welch Allyn
Welch Allyn Blood Pressure Hose, 5ft.	4500-30	1	Welch Allyn
Cable, USB A to 5 pin mini	704889	1	Welch Allyn
DPAC Wireless Module	706514	1	Welch Allyn
Needle Nose Pliers		1	Tool/Supply Store
Wire Cutter		1	Tool/Supply Store

Description	Part Number	Qty	Source
Tweezers		1	Tool/Supply Store
#2 Phillips Screwdriver		1	Tool/Supply Store
T10 Torx Driver		1	Tool/Supply Store
4" PVC Pipe		1	Tool/Supply Store
Soldering Station		1	Tool/Supply Store
Cable Tie Tool - T9921	GS2B	1	Marsh Electronics +1 800 877-8919
*Setra Pressure Meter	2270-01	1	Setra +1 800 257 3872
*Nitech Pressure Meter	2000 in	1	Nitech +1 800 547 6557
Nellcor Sensor Ext Cable (4' Cable)	Dec-4	1	Nellcor +1 800 635 5267
Nellcor Sensor Ext Cable (8' Cable)	Dec-8	1	Nellcor +1 800 635 5267
Nellcor Sensor	DS-100A	1	Nellcor +1 800 635 5267
Masimo SpO ₂ Tester	1795	1	Masimo +1 800 326-4890
Nellcor SRC-MAX SpO ₂ Tester	SRC-MAX	1	Nellcor +1 800 635 5267
Masimo Patient Cable	1005	1	Masimo +1 800 326-4890
Masimo Adult SpO ₂ Reusable Sensor	1269	1	Masimo +1 800 326-4890
Digital Volt Meter with 4 1/2 Digit Display		2	Electronics Supply Store
Power Supply: 0-20 Vdc adjustable with 0-3A output		1	Electronics Supply Store
Wireless Router		1	Electronics Supply Store
Ethernet Cable		1	Electronics Supply Store
IBM compatible computer Windows 2000, XP, NT4		1	

* Only requires one of the pressure meters

To disassemble Spot Vital Signs LXi:

1. Disconnect the power and all accessories from the Spot Vital Signs LXi.
2. Remove the four screws holding the battery door using a phillips-head screwdriver. Remove the battery door to expose the battery.

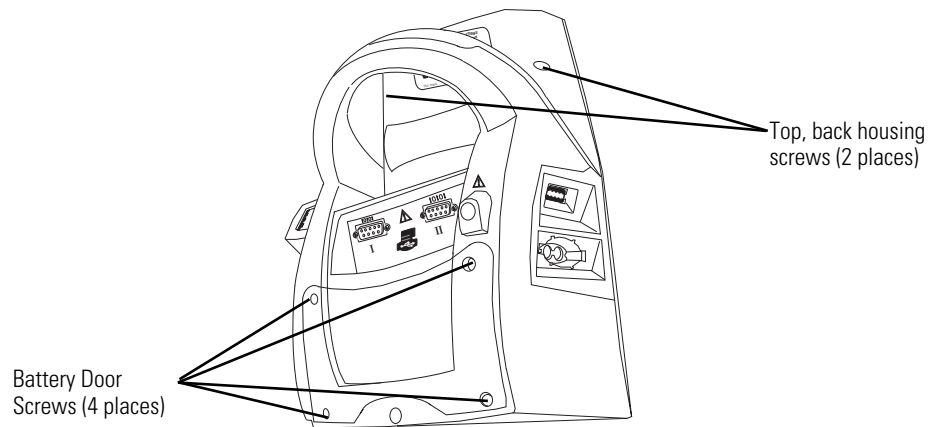

3. Tip the Spot Vital Signs LXi backward and slide the battery out. Disconnect the one-way connector.
4. Remove the two screws inside the battery housing that are identified with arrows molded into the housing and the two screws at the top of the back upper housing.
5. Hold the device together, lay the back housing on the bench, and carefully lift the top housing off.

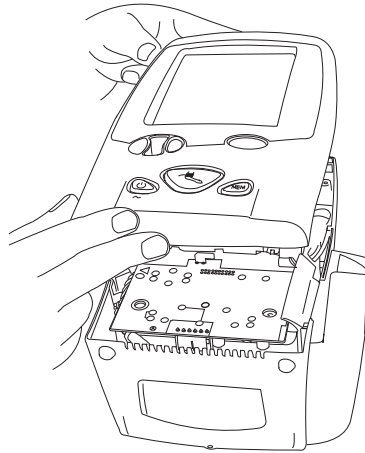

6. Remove the screw and slightly lift the circuit board from the right facing side and disconnect the flex cable (J103).

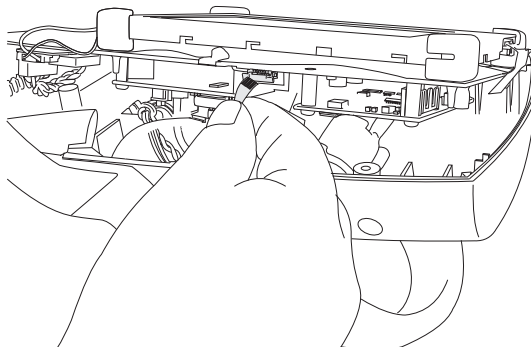

7. Observe the locations of the two tubes before disconnecting. Lift and disconnect the wire harnesses and the pneumatic tubing. The two wire harnesses are a 6-wire harness that connects to J104 and a 2-wire harness that connects to J80 on the small, mounted blood pressure board.

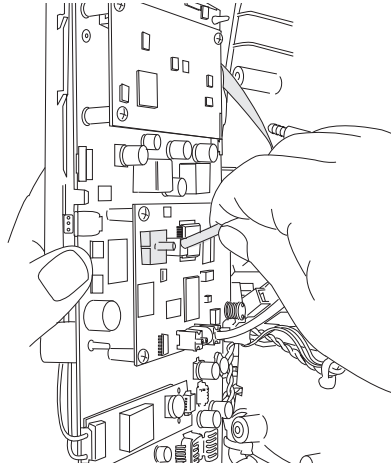

8. Disconnect the red electrical connector and the gold ribbon connector. This is located on the main board. Lift up the tab on the white cable retainer so cable can slide out after it is unplugged.

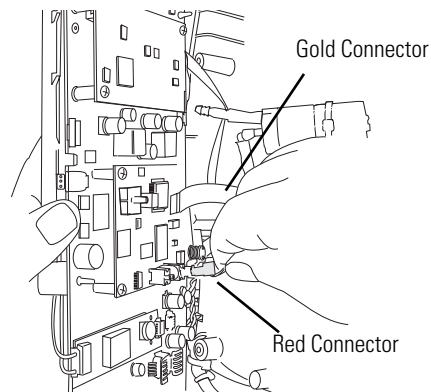

9. Lift the flap on the beige connector (large ribbon cable) to remove the main board. This releases the serial board cable from connector J108.

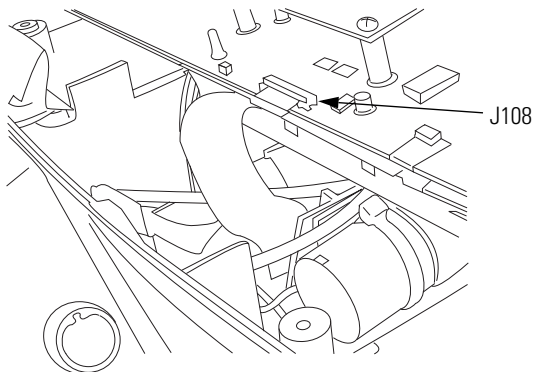

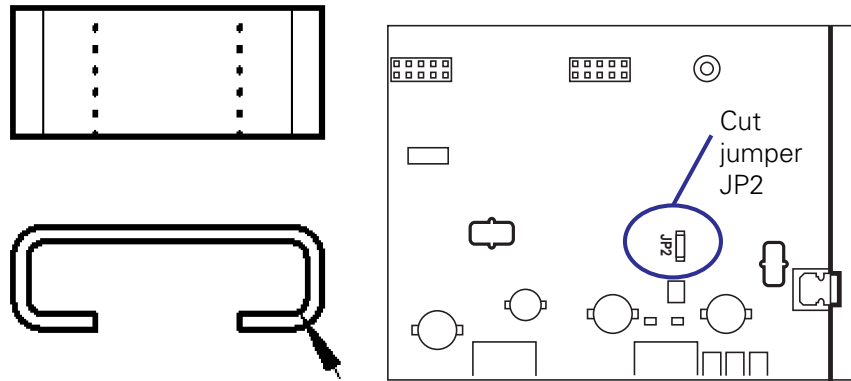

Note This step only applies to devices configured with Masimo SpO₂ sensors. Cut jumper JP2 with diagonal cutting pliers twice so that it is open. Cut it on each end on the dotted lines as illustrated, so that it is an open connection.

Key Pad Disassembly

1. Gently pull the button switch array out of the cover.
2. Align and push the new button switch array into place.

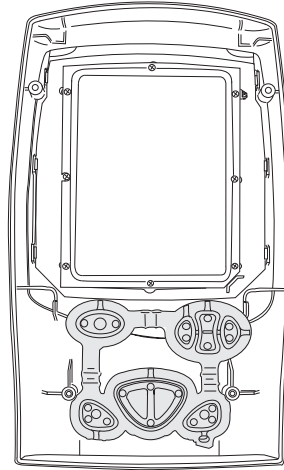

SpO₂ Circuit Board Disassembly

Note To assure proper SpO₂ operation, replace the SpO₂ board using only the Welch Allyn specified part.

To assure patient electrical isolation, after the main board is nearly back in position, verify that the SpO₂ flex cable is freely floating in space and is not pressed up against the main board.

Masimo

Note Masimo configurations ship with an EMI foil shield, copper tape, and Nomex insulator. These components are removed from the illustrations to show clarity of detail. These components must be reinstalled to comply with EMC requirements.

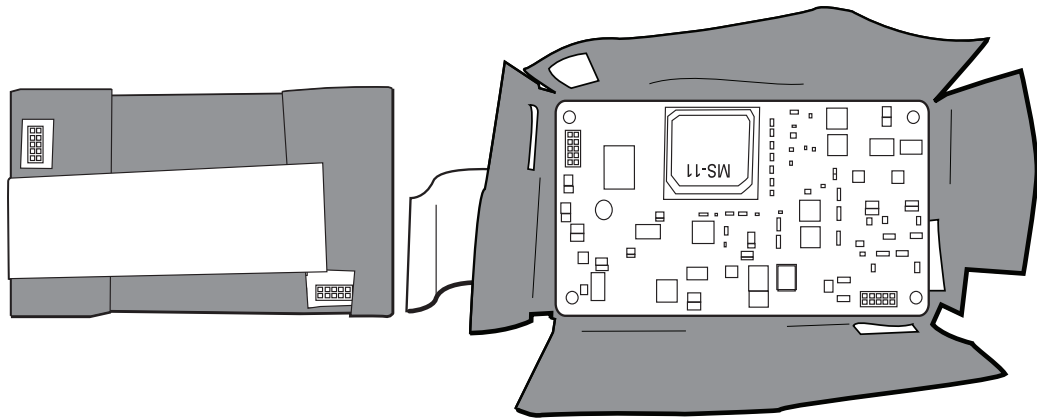

1. Lay the LCD flat on an ESD mat.
2. Find the double-stack of circuit boards and remove the four corners screws. Carefully lift the circuit board straight up.

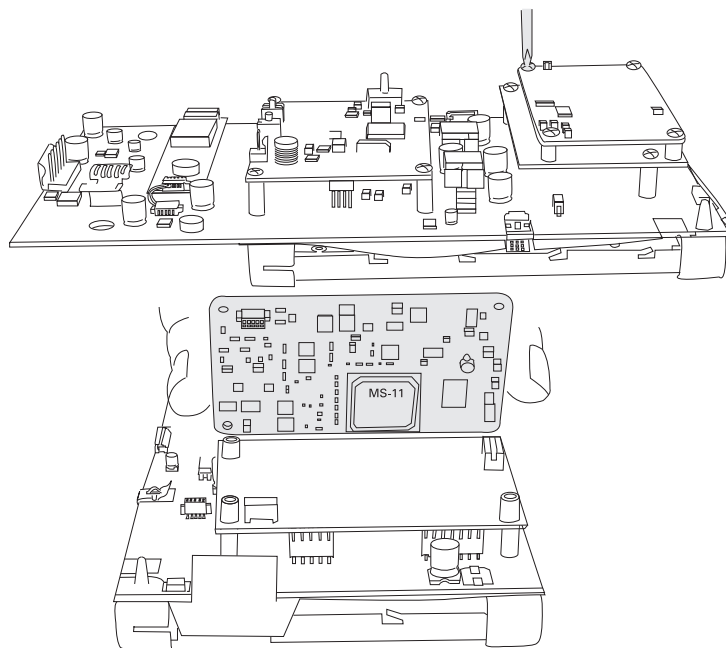

3. Remove the three screws on the circuit board located behind the LCD.

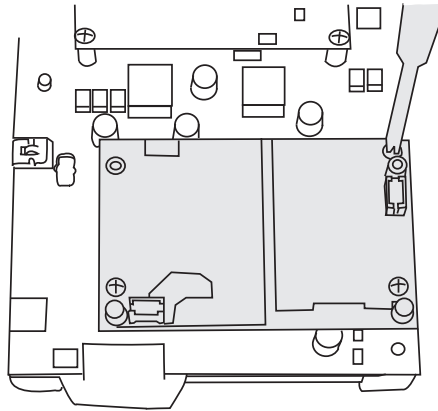

4. Slightly rock the circuit board back and forth while lifting straight up.

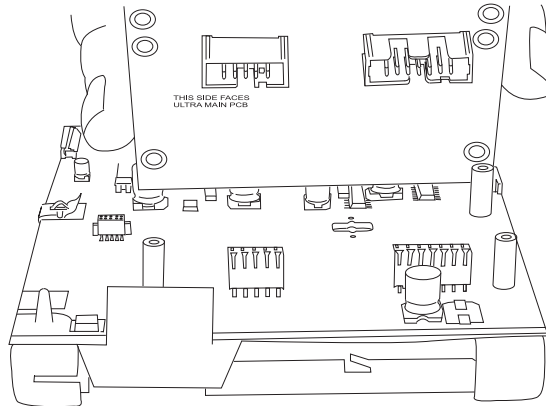

5. Replace with a new circuit board.

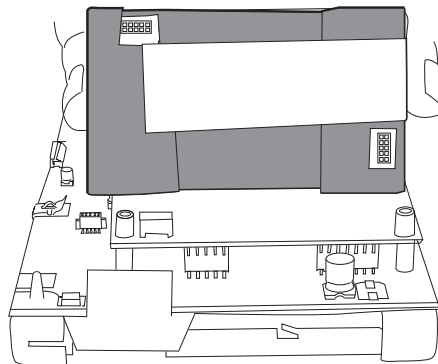

Nellcor

1. Lay the LCD flat on an ESD mat.
2. Remove the three screws on the circuit board located behind the LCD.

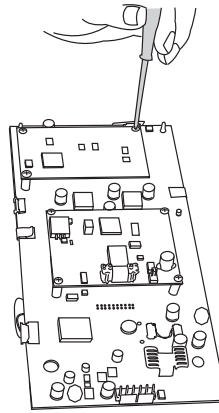

3. Slightly rock the circuit board back and forth while lifting straight up.

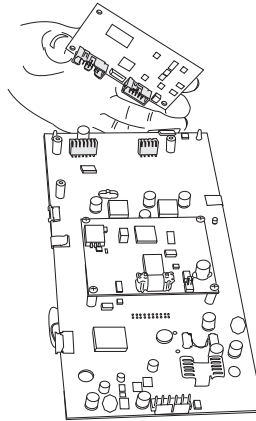

4. Replace with a new circuit board and set the dip switches to match the original board (dip 1 and 2: up / dip 3 and 4: down).

Blood Pressure Circuit Board Disassembly

Note When replacing the NIBP board see “NIBP board Initialization” on page 62 for instructions.

Remove the four screws and carefully lift the circuit board straight up. There is one stationary connector.

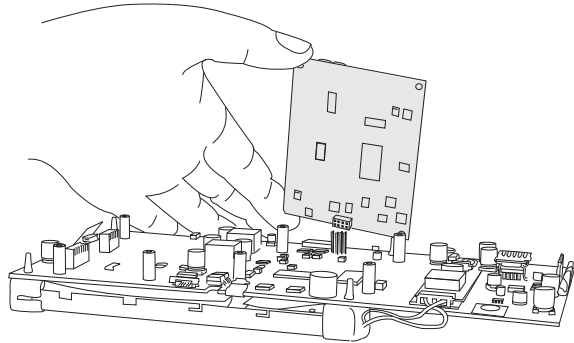
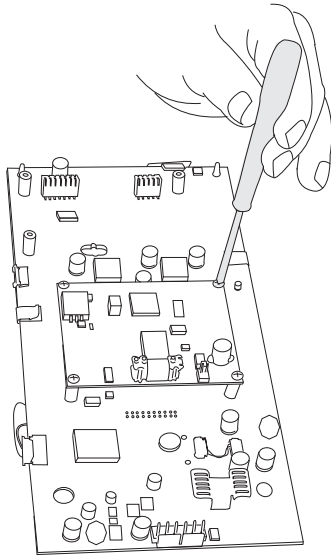

LCD Inverter Ballast Board Disassembly

This is a small board held in place with two-sided tape. It is located towards the bottom of the main board. Remove the connector at each end and pull straight up while taking care not to damage the board because the adhesive tape has considerable sticking strength.

LCD Disassembly

1. Remove the main board. At the bottom of this board is a circuit board with a pink connector at the bottom.

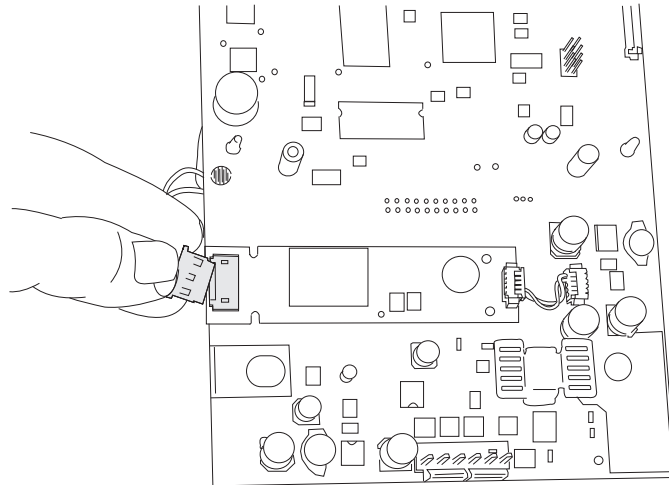

2. Pull the brown tabs of the top connector forward and remove the ribbon cable. Inspect connector tabs for wear and replace if worn.
3. Turn the board over and pull back the soft rubber holders. Pull the cable from the lug to remove the grounding strap and remove the LCD.

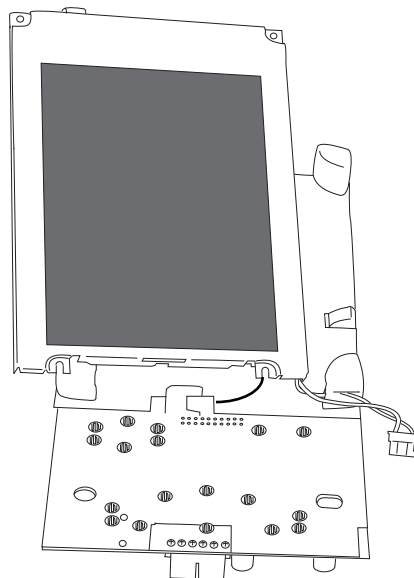

4. Replace with a new LCD.

Pump Disassembly

Note For proper blood pressure operation, replace the pump using only the Welch Allyn specified part.

To assure patient electrical isolation, route the pump wires through the rear housing clip feature (near the pump terminals) and held in place with a tie-wrap to the holes in the rear housing at the back of the battery compartment.

To assure patient electrical isolation, do not modify the length of the pump wires.

1. Snip the wire ties (2 places).

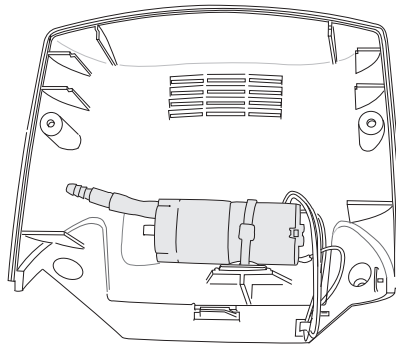

2. Disconnect the pneumatic tubing and unhook the wiring.
3. Replace with a new pump.

RS232-Communication Circuit Board Disassembly

1. Remove the pneumatic connector and associated hoses from the pump and the two screws in the rear housing. Remove the associated hoses.
2. Release the catch and remove the cover and inner handle assembly.
3. Remove the connection port panel.
4. Remove the two screws inside the back housing and the ribbon cable that hold the RS232 board in place. Take care since the connector is easily broken.
5. Slide the board straight out and remove the wire harness.

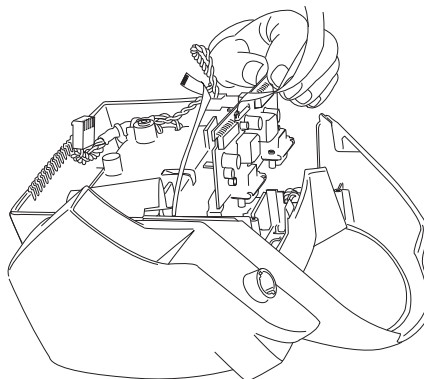

6. Replace with a new circuit board.

Fan and Power Circuit Board Disassembly

Note To prevent buildup of hydrogen gas, replace the fan using only the Welch Allyn specified part.

This is a small board held in place with two-sided tape and one connector. Remove the screw before disconnecting the connector.

Thermometry Circuit Board Disassembly



Caution To assure patient electrical isolation, trap the flex cable to the thermometer pod behind the clip on the main housing adjacent to the main board connection point.

Caution To assure patient electrical isolation, verify that the correct flex cable is used to connect the thermometer pod to the main board. The Braun and SureTemp Plus flex cables are slightly different in length and are not interchangeable.

Caution To protect the user from high voltage, properly install the thermometer pod insulating paper separating the LCD ballast wires from the housing crack.

SureTemp Plus



Caution Do not attempt to repair or clean the solder joints on either SureTemp Plus board. Incorrect flux or technique can degrade thermometer accuracy.

1. Remove the two screws located at the thermometer housing with a T-10 torx wrench. Save the Nomex.

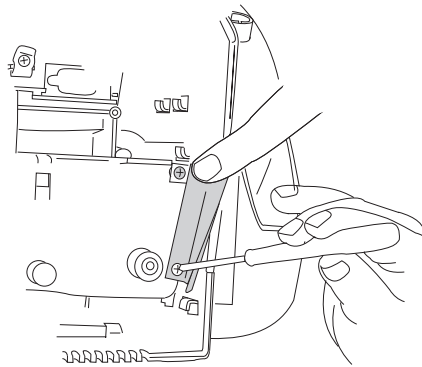

2. Locate the path of the notched tabs on the housing. Slide the housing up and out following this path and set the case aside.

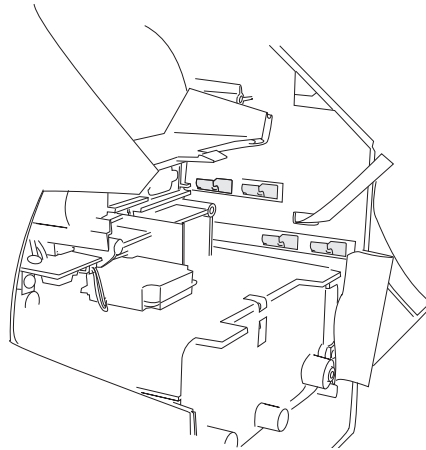

3. Remove the four screws from the mounting plate and save the Nomex. This exposes the circuit board.

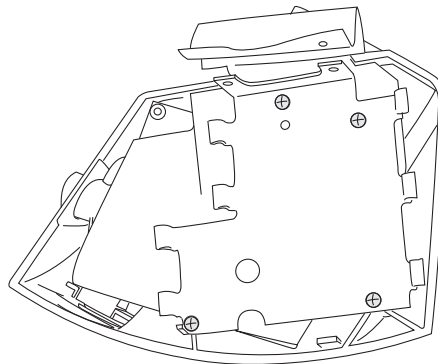

4. Remove the three Torx screws (T10) on the board (one on bottom and one on either side of the probe well cover) and lift the board out of the housing and orient the part as shown.

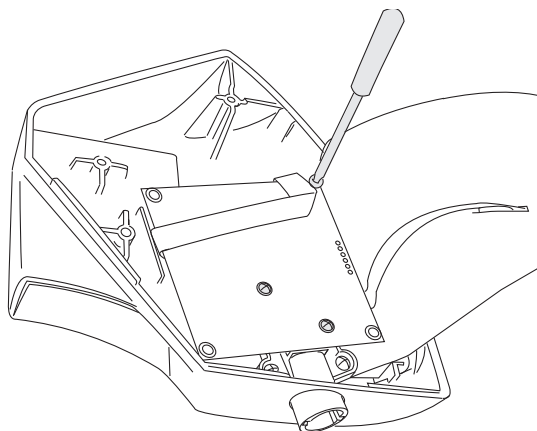

5. Disconnect all connectors and replace with a new board.

To replace the temperature connector, remove the one screw holding the temperature board and connector. Verify the Nomex is properly mounted upon reassembly.

When replacing the SpO₂/blood pressure housing, verify the orange and white twisted wire is pushed as far into the handle housing as possible. Failure to do so can cause the wires to stretch when the SpO₂/blood pressure housing is inserted.

Braun ThermoScan PRO 4000

1. Remove the two screws located at the thermometer housing with a T-10 torx wrench. Save the Nomex.

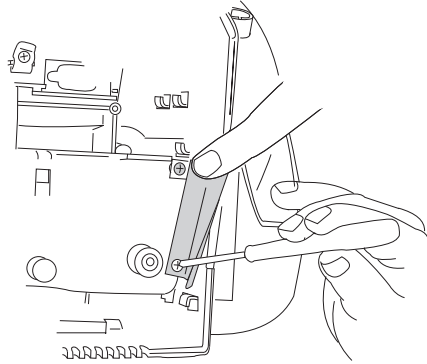

2. Locate the path of the notched tabs on the housing. Slide the housing up and out following this path and set the case aside.
3. Remove the four screws that hold the metal shield in place.

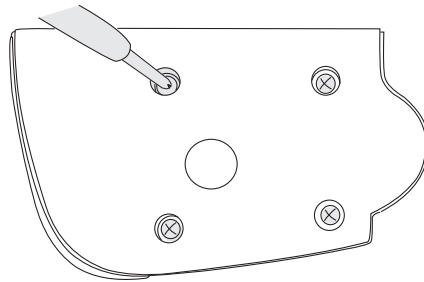

4. Remove the springs and posts. Carefully rock the board back and forth while lifting straight up.

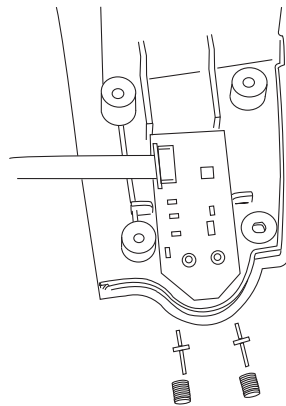

5. Disconnect all connectors and replace with a new board.
6. Reassembly is the reverse of disassembly.

12

Repair Test Specifications

This appendix refers to the Spot Vital Signs LXi without pneumatics (tubing and cuff), temperature probe, SpO₂ probe, or main battery attached, unless otherwise noted.

Use the Repair Software for the performing the tests on the Spot Vital Signs LXi. The standard test voltage, unless otherwise stated is 6.5 Vdc (+0/-0.25 Vdc). Unless otherwise stated, all calibrated volumes are ± 10 cc of the stated volume.

General Unit Test

A-D Noise Test

The A-D Noise Test is defined as the amount of noise on the Spot Vital Signs LXi A-D pressure channel; over a 1 second sample time while 0.0 mmHg is applied to the Device pressure port. The maximum limit is 0.050 mmHg.

Leak Test

The Leak Test is defined as the amount of pressure drop that is recorded over a 15-second interval with a 100cc cylinder attached to the Spot Vital Signs LXi pressure port and that volume having a stabilized pressure of 250 mmHg. The maximum limit is 6 mmHg.

Inflation Test

The Inflation Test is defined as the amount of time the Spot Vital Signs LXi pump can inflate a 250 cc cylinder from 5 mmHg to 210 mmHg. The maximum limit is 7 seconds.

Dump Test

The Dump Test is defined as the amount of time it takes Spot Vital Signs LXi to deflate a 500 cc cylinder from 260 mmHg to less than 15 mmHg. The maximum limit is 10 seconds.

Pneumatic Accuracy Test

Enter the Internal Configuration Mode to perform this test (see "Temperature Functional Check" on page 77).

Perform an Auto-zero before starting this test (see "Temperature Functional Check" on page 77). The Pneumatic Accuracy test is defined as the comparison of Spot Vital Signs LXi's pressure measurement and applied pressure at 0, 50, 150, and 250 mmHg. The

specification for each reading is within ± 3 mmHg of the target pressure except for the 0 mmHg reading which is within ± 1.0 mmHg.

Valve Control Test

Perform the valve control test using the Welch Allyn Spot LXi Service Tool, see “Valve control test” on page 67.

Voltage Calibration

Calibrate the Spot Vital Signs LXi battery voltage measurement circuit at $5.5 + 0.1V$ DC.

After performing a successful battery measurement circuit calibration, Spot Vital Signs LXi’s memory will store a calibration signature of up to four printable characters.

Blank Mode Current Test

The Blank Mode Current Test is defined as the amount of current drawn through the battery terminals. All LCD segments, the back light, and the SpO₂ mode are all turned off. The limit is 200 mA maximum.

Back Light (Idle) Current Test

The Back Light Current Test is defined as the amount of current drawn through the battery. All LCD segments and the back light are turned on while the SpO₂ mode is turned off. The limit is 400 mA maximum.

Valve/Pump Mode Current Test

The Valve/Pump Mode Current Test is defined as the amount of current that is drawn through the battery terminals; Spot Vital Signs LXi is in the Blank Mode while the valve and pump are actuated to on. The limit is 2.0 A maximum.

Interface Test

When given the proper commands, the Display Window will turn on or off all segments and turn on or off the back light. When given the proper command, the buzzer sounds to verify operation. The user determines the pass/fail criteria.

Temperature Option Requirements

Accuracy Test

Verify the accuracy of the temperature module is within $\pm 0.2^\circ$ F for readings with a normal temperature of 97.3° F (36.3° C) using a Cal Key (5200-25). Verify Spot Vital Signs LXi can read a temperatures of 96.4° F (35.8° C) and 106° F (41.1° C) within $\pm 0.3^\circ$ F/ $\pm 0.2^\circ$ C using a Welch Allyn 9600 Plus Calibrator.

Temperature Probe Test

Spot Vital Signs LXi displays “ORL” after you remove the blue thermometer probe from the blue probe well.

SpO₂ Option Requirements

These tests are only valid on Spot Vital Signs LXi models with the Masimo or Nellcor SpO₂ option.

SpO₂ Functional Test

See [“To begin functional verification of the Masimo SpO₂”](#) or [“To begin functional verification of the Nellcor SpO₂”](#) on page 87 for the functional test.

SpO₂ Mode Current Test

The SpO₂ Mode Current Test is defined as the amount of current, less the Blank Mode Current, that is drawn through the battery terminals, placing Spot Vital Signs LXi in the Blank Mode, actuating the SpO₂ mode and applying any SpO₂ signal to the device. The maximum limit is 120 mA maximum.

Fail Safe Test

Over Pressure Test

Verify that Spot Vital Signs LXi can detect over pressure on the pneumatic system between 296 mmHg and 329 mmHg.

Over 15 mmHg

Verify that Spot Vital Signs LXi can detect static pressure over 15 mmHg for 180 seconds.

Interconnect Diagram 2

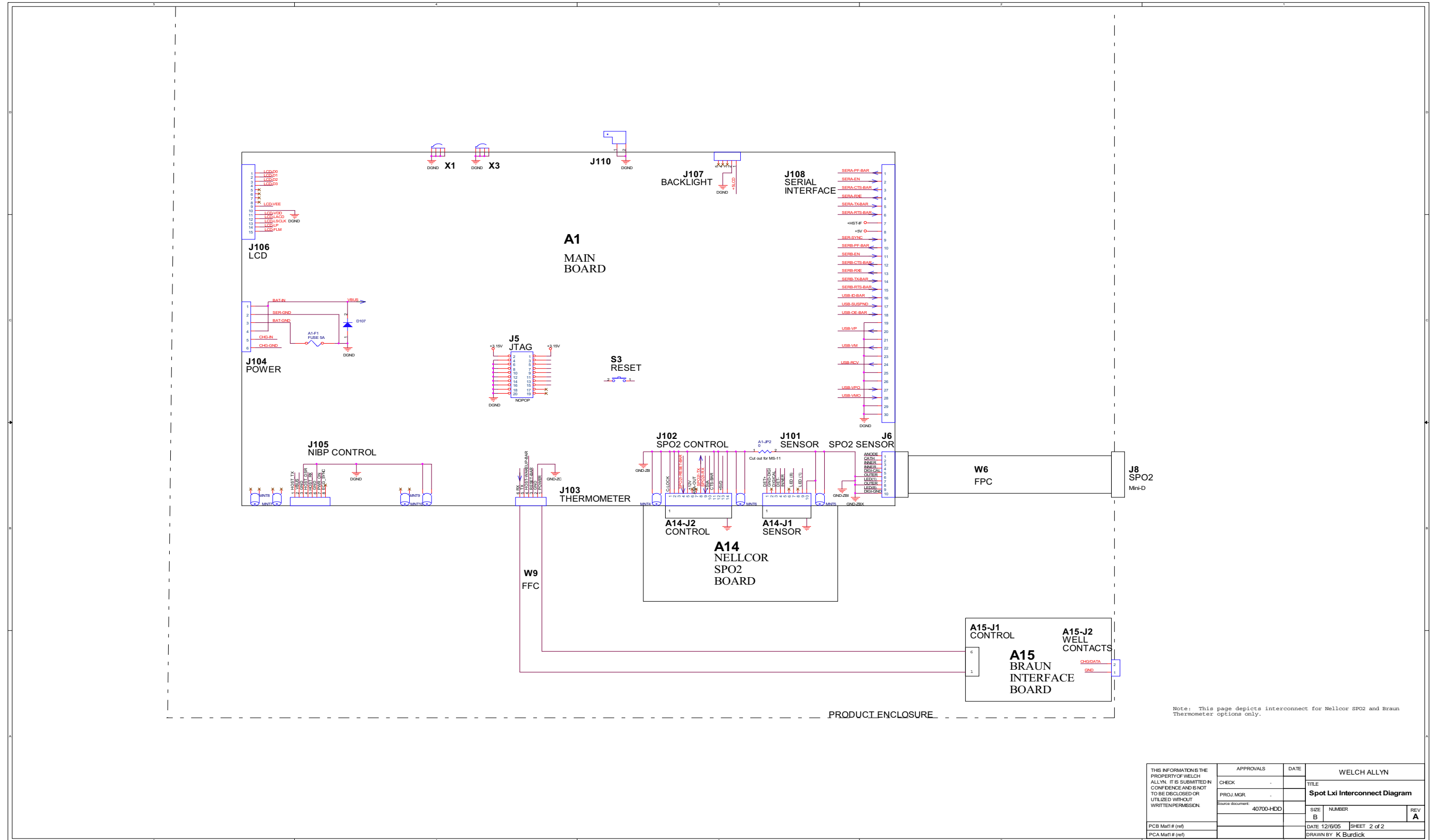

THIS INFORMATION IS THE PROPERTY OF WELCH ALLYN. IT IS SUBMITTED IN CONFIDENCE AND IS NOT TO BE DISCLOSED OR UTILIZED WITHOUT WRITTEN PERMISSION.	APPROVALS	DATE	WELCH ALLYN	
	CHECK	-	TITLE	Spot Lxi Interconnect Diagram
	PROJ.MGR	-	SIZE	NUMBER
	Source document: 40700-HDD		B	REV
PCB Mat# (ref)		DATE 12/6/05	SHEET 2 of 2	A
PCA Mat# (ref)		DRAWN BY K Burdick		

WelchAllyn®

Advancing Frontline Care™

Reorder No. 4500-89
Material No. 718440 Ver. A