

# Welch Allyn Connex<sup>®</sup> Vital Signs Monitor 6000 Series<sup>™</sup>

---



---

## Directions for use

Software version 2.0X

**WelchAllyn<sup>®</sup>**

Advancing Frontline Care<sup>™</sup>

© 2012 Welch Allyn. All rights are reserved. To support the intended use of the product described in this publication, the purchaser of the product is permitted to copy this publication, for internal distribution only, from the media provided by Welch Allyn. No other use, reproduction, or distribution of this publication, or any part of it, is permitted without written permission from Welch Allyn. Welch Allyn assumes no responsibility for any injury to anyone, or for any illegal or improper use of the product, that may result from failure to use this product in accordance with the instructions, cautions, warnings, or statement of intended use published in this manual.

Welch Allyn, Connex, SureTemp, FlexiPort, and SureBP are registered trademarks of Welch Allyn.

Vital Signs Monitor 6000 Series and PartnerConnect are trademarks of Welch Allyn.

Integrated Pulmonary Index is a trademark of , and Oridion and Microstream are registered trademarks of, Oridion Medical 1987 Ltd. No implied license. Possession or purchase of this device does not convey any express or implied license to use the device with unauthorized CO2 sampling products which would, alone, or in combination with this device, fall within the scope of one or more of the patents relating to this device and/or CO2 sampling products.

Radical-7R, Pulse CO-Oximeter, rainbow Acoustic Monitoring, RRA, and ReSposable are trademarks of, and SET, LNCS, SpHb, rainbow, and Masimo are registered trademarks of, Masimo Corporation. Possession or purchase of a Masimo-equipped device does not convey any express or implied license to use the device with unauthorized sensors or cables which would, alone or in combination with this device, fall within the scope of one or more of the patents relating to this device.

Nellcor and OxiMax are registered trademarks of Nellcor Puritan Bennett Inc.

Braun and ThermoScan are registered trademarks of Braun GmbH.

Health o meter is a registered trademark of Sunbeam Products, Inc., used under license.

Software in this product is Copyright 2012 Welch Allyn or its vendors. All rights are reserved. The software is protected by United States of America copyright laws and international treaty provisions applicable worldwide. Under such laws, the licensee is entitled to use the copy of the software incorporated with this instrument as intended in the operation of the product in which it is embedded. The software may not be copied, decompiled, reverse-engineered, disassembled, or otherwise reduced to human-perceivable form. This is not a sale of the software or any copy of the software; all right, title, and ownership of the software remain with Welch Allyn or its vendors.

For patent information, please visit [www.welchallyn.com/patents](http://www.welchallyn.com/patents).

For information about any Welch Allyn product, contact Welch Allyn Technical Support: [www.welchallyn.com/about/company/locations](http://www.welchallyn.com/about/company/locations).

**REF** 104730 (CD)  
DIR 80017136 Ver. H

**REF** 104731 (printed copy)  
Material Number 718079, DIR 80017136 Ver. H



Welch Allyn, Inc.  
4341 State Street Road  
Skaneateles Falls, NY 13153-0220 USA

[www.welchallyn.com](http://www.welchallyn.com)

**EC** **REP**

Regulatory Affairs Representative  
Welch Allyn Limited  
Navan Business Park  
Dublin Road  
Navan, County Meath  
Republic of Ireland



Advancing Frontline Care™

# Contents

---

<b>Introduction</b> .....	<b>1</b>
Indications for use .....	1
Contraindications .....	2
<b>Symbols</b> .....	<b>3</b>
<b>Screen elements</b> .....	<b>7</b>
<b>About warnings and cautions</b> .....	<b>11</b>
General warnings and cautions .....	11
<b>Physical design</b> .....	<b>17</b>
Controls, indicators, and connectors .....	18
<b>Setup</b> .....	<b>21</b>
Supplies and accessories .....	21
Insert the battery .....	21
Mount the monitor .....	22
Attach the probe well .....	23
Attach the temperature probe .....	24
Remove the temperature probe and well .....	24
Connect the NIBP hose .....	25
Disconnect the NIBP hose .....	25
Connect the SpO2 cable or the SpO2/RRa dual cable .....	25
Disconnect the SpO2 cable or the SpO2/RRa dual cable .....	27
Attach a USB accessory .....	27
Detach a USB accessory .....	28
Insert a new roll of paper .....	28
Connect AC power .....	29
Disconnect AC power .....	30
<b>Startup</b> .....	<b>31</b>
Power .....	31
Power up the monitor .....	32
Power down the monitor .....	33
Reset the monitor .....	33
Set the date and time .....	34
Enter clinician information .....	34
Set the default configuration .....	34
<b>Navigation</b> .....	<b>37</b>
Home tab .....	37

Device Status area .....	37
Content area .....	40
Navigation area .....	41
<b>Using the keypad, keyboard, and barcode scanner .....</b>	<b>43</b>
Open the numeric keypad .....	43
Numeric keypad .....	43
Enter a number .....	44
Close the numeric keypad .....	44
Open the keyboard .....	44
Keyboard .....	44
Enter a letter or number .....	46
Enter a symbol or special character .....	46
Enter a diacritical mark .....	46
Close the keyboard .....	47
Use a barcode scanner .....	47
<b>Connex CS .....</b>	<b>49</b>
Overview .....	49
Monitor tab .....	50
Connect to the central station .....	51
Disconnect from the central station .....	51
Continuous patient monitoring .....	52
Activate the Continuous Monitoring profile .....	52
Pause continuous monitoring (Standby mode) .....	52
Resume continuous monitoring .....	53
End continuous monitoring .....	53
Assign a patient and location .....	54
<b>Profiles .....</b>	<b>57</b>
Continuous Monitoring profile .....	57
Saving vital sign measurements (Continuous Monitoring profile) .....	58
Intervals Monitoring profile .....	59
Spot Check profile .....	59
Triage profile .....	60
Saving vital sign measurements (Intervals Monitoring, Spot Check, and Triage profiles) .....	60
Profile feature comparison .....	61
Select a profile .....	61
<b>Patient data management .....</b>	<b>63</b>
Add a patient to the patient list .....	63
Load patient data with the barcode scanner .....	64
Select a patient .....	64
Manage patient records (Continuous Monitoring profile) .....	65
Manage patient records (Intervals Monitoring, Spot Check, and Triage profiles) .....	66
Printer .....	67
Delete a patient from the list .....	67
<b>Alarms .....</b>	<b>69</b>
Reset (pause or turn off) audio alarms .....	72
Cancel a paused alarm .....	74

Adjust vital sign alarm limits .....	74
Modify audio alarm notification .....	75
Alarm messages and priorities .....	76
Nurse call .....	79
<b>Patient monitoring .....</b>	<b>81</b>
Capnography (CO2) .....	81
Respiration rate .....	85
IPI .....	86
Acoustic respiration rate (RRa) .....	89
NIBP .....	92
Temperature .....	103
SpO2 .....	114
SpHb .....	120
Pulse rate frame .....	124
Manual parameters frame .....	126
<b>Maintenance and service .....</b>	<b>129</b>
Perform periodic checks .....	129
Replace the printer paper .....	129
Change the battery .....	130
Clean the monitor .....	132
Clean the accessories .....	133
Clean the stand .....	133
<b>Advanced settings .....</b>	<b>135</b>
General .....	135
Parameters .....	139
Data management .....	145
Network .....	147
Service .....	149
<b>Troubleshooting .....</b>	<b>151</b>
CO2 messages .....	151
RRa messages .....	153
NIBP messages .....	153
SpO2 and SpHb messages .....	154
Temperature messages .....	155
Weight scale messages .....	156
Patient data management messages .....	156
Communications module messages .....	157
Radio messages .....	157
Ethernet messages .....	158
USB messages .....	158
System messages .....	158
Battery power manager messages .....	159
Configuration Manager messages .....	159
Printer messages .....	159
Network messages .....	160
Problems and solutions .....	160
<b>Specifications .....</b>	<b>163</b>
Physical specifications .....	163

Environmental specifications .....	173
Monitor radio .....	173
Configuration options .....	174
<b>Standards and compliance .....</b>	<b>175</b>
General compliance and standards .....	175
General radio compliance .....	176
<b>Guidance and manufacturer's declaration .....</b>	<b>179</b>
EMC compliance .....	179
Emissions and immunity information .....	179
<b>Warranty .....</b>	<b>181</b>

# Introduction

---

This directions for use describes the capabilities and operation of the monitor. The information, including the illustrations, covers all configuration options. If your monitor configuration lacks any of these options, some information in this manual might not apply.

Before using the monitor, you must familiarize yourself with all warnings and cautions, with the steps to power up the monitor, and with the sections of this directions for use that pertain to your use of the monitor. You must also familiarize yourself with all information that accompanies the accessories you use.

**Note** Some product features described in this publication might not be available in your country. For the latest information about products and features, please call Welch Allyn Customer Care.

## Indications for use

The Connex VSM 6000 series of monitors is intended to be used by clinicians and medically qualified personnel for monitoring of neonatal, pediatric, and adult patients for

- noninvasive blood pressure (NIBP)
- pulse rate (PR)
- noninvasive functional oxygen saturation of arteriolar hemoglobin (SpO<sub>2</sub>)
- body temperature in normal and axillary modes

The most likely locations for patients to be monitored are general medical and surgical floors, general hospital, and alternate care environments. Monitoring can be accomplished on the VSM 6000 series bedside monitor itself, and the VSM 6000 series bedside monitor also can transmit data continuously for secondary remote viewing and alarming (e.g., at a central station). Secondary remote viewing and alarming features are intended to supplement and not replace any patient bedside monitoring procedures.

The optional Masimo rainbow<sup>®</sup> SET Pulse CO-Oximeter<sup>™</sup> and accessories are indicated for the continuous noninvasive monitoring of functional oxygen saturation of arterial hemoglobin (SpO<sub>2</sub>), pulse rate (PR), total hemoglobin concentration (SpHb<sup>®</sup>), and/or respiration rate (RRa<sup>™</sup>). The Masimo rainbow SET Radical-7R<sup>™</sup> Pulse CO-Oximeter and accessories are indicated for use with adult, pediatric, and neonatal patients during both motion and no-motion conditions, and for patients who are well or poorly perfused in hospitals and hospital-type facilities.

The optional Oridion<sup>®</sup> module and accessories are intended for the continuous noninvasive measurement and monitoring of carbon dioxide concentration of the expired

and inspired breath (etCO<sub>2</sub> and FiCO<sub>2</sub>) and respiration rate (RR). It is intended for use with neonatal, pediatric, and adult patients in hospitals and hospital-type facilities.

The optional Oridion module also provides the clinician with an Integrated Pulmonary Index™ (IPI). The IPI is based on four parameters provided by the monitor: end-tidal carbon dioxide (etCO<sub>2</sub>), respiration rate (RR), oxygen saturation (SpO<sub>2</sub>), and pulse rate (PR). The IPI is a single index of an adult or pediatric patient's ventilatory status displayed on a scale of 1–10, where 10 indicates optimal pulmonary status. IPI monitoring displays a single value that represents the patient's pulmonary parameters and alerts clinicians to changes in the patient's pulmonary status.

The IPI is an adjunct to, and is not intended to replace, vital signs monitoring.

Optional compatible weight scales (e.g., Health o meter®) can be used for height, weight, and BMI input.

The Connex VSM 6000 series of monitors also contains the Welch Allyn Applications Framework ("Framework"). The Framework is general-purpose software that allows medical device and non-medical device software applications to be run on the monitor independently of, and isolated from, the monitor's vital signs monitoring functionality. All such applications are intended to be used on the monitor by trained professionals in a healthcare setting.

This product is available for sale only upon the order of a physician or licensed healthcare professional.

## Contraindications

This system is not intended to be used:

- on patients connected to heart/lung machines
- on patients being transported outside a healthcare facility
- within the controlled access area of MRI equipment
- in a hyperbaric chamber
- in the presence of flammable anesthetics
- in the presence of electrocauterization devices

For contraindications of patient sensors, consult the directions for use provided with the sensor.



# Symbols

---

## Documentation symbols



**WARNING** The warning statements in this manual identify conditions or practices that could lead to illness, injury, or death.



**CAUTION** The caution statements in this manual identify conditions or practices that could result in damage to the equipment or other property, or loss of data. This definition applies to both yellow and black and white symbols.



**WARNING** Hot surface. Do not touch.



Follow instructions for use — mandatory action.



Consult operating instructions.

## Power symbols



Power on/Display power-saving



Equipotential terminal



(on the display) monitor is plugged into Alternating Current power







Battery absent or faulty







(on the monitor, green indicator) Alternating Current power present, battery fully charged















Battery charge level

	(on the monitor, amber indicator) Alternating Current power present, battery is charging		Battery cover
	Alternating Current (AC)		Rechargeable battery
	Li-ion battery		







## Connectivity symbols

	USB		Ethernet RJ-45
	Wireless signal strength <ul style="list-style-type: none"> <li>• Best (4 bars)</li> <li>• Good (3 bars)</li> <li>• Fair (2 bars)</li> <li>• Weak (1 bar)</li> <li>• No signal (no bars)</li> <li>• No connection (blank)</li> </ul>		Nurse call

## Miscellaneous symbols

	CO2 sampling input		CO2 sampling output/exhaust
	Manufacturer		Limited rotation/Turn completely to right
	Reorder number		Serial number
	Do not reuse		China RoHS markings for control of pollution caused by electronic information products. XX indicates Environmentally Friendly Use Period in years.
	Nonionizing electromagnetic radiation		Recycle the product separate from other disposables
	Restrictions for use of wireless device in Europe. European Community's Class 2 radio equipment.		Call for maintenance

---

	Defibrillation-proof Type BF applied parts		Do not expose to open flame
	Altitude range		Not for injection
	Transport and storage temperature range		Authorized Representative of the European Community

---



# Screen elements

## Global navigation, controls, and indicators



Select option



Process indicator for activities like acquiring measurements and connecting to a central station

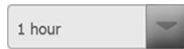

Select item from list



Display lock/unlock



Increase or decrease value

## Monitoring and connectivity



Connect to central station and retain patient data



Disconnect from central station but continue monitoring and retain patient data



Temporarily pause continuous monitoring but retain patient data



End continuous monitoring session for current patient and clear patient data



Connected to central station (Device Status area)



Not connected to central station (Device Status area)

**NIBP**

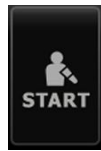

NIBP start



NIBP stop



Intervals status indicators



NIBP view toggle



**Temperature**



Temperature site control



Direct mode selector

**SpO2 and Pulse rate**



Pulse amplitude bar



SatSeconds timer (Nellcor feature only)



SpO2 view toggle



Response mode selector (Fast mode selected)



Pulse rate (in beats per minute)

**Total hemoglobin (SpHb)**



SpHbv view toggle



Averaging mode selector (Long mode selected)

**Capnography (CO2)**



CO2 pump start



CO2 pump stop

---

### Capnography (CO2)

---



etCO2 view toggle



IPI view toggle

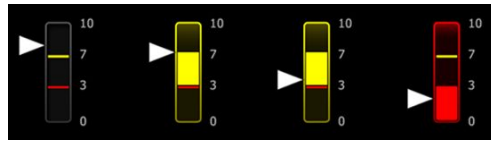

IPI graphic indicators

---

### RRa

---



Respiration indicator



Averaging mode selector  
(Fast mode selected)

---

### Manual parameters

---

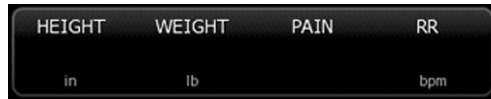

Manual parameter selector

---

### Alarm and information messages

---



Alarm limit control



Alarm On/Off toggle



Multiple alarms toggle

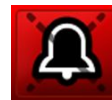

Alarm audio paused



Alarm active



Information message

---

### Patient data management

---













Diacritical marks key  
(available for languages that  
use diacritical marks;  
appearance differs based on  
language)









Symbols key

**Patient data management**

	Send patient data		Print patient data/patient trend data
	Cancel action		Add patient identifiers
	Retrieve patient list from the network		Select patient from List tab
	Delete patient from List tab		Clear patient context from Summary tab
	Forward or backward in Review tab		Proceed to the next field to input patient information

**Settings**

	Save configuration settings		Select state or view
	Save to USB flash drive		Configure from USB flash drive
	Restore factory default settings		Close Advanced settings



## About warnings and cautions

---

Warning and caution statements can appear on the monitor, on the packaging, on the shipping container, or in this document.

The monitor is safe for patients and clinicians when used in accordance with the instructions and the warning and caution statements presented in this manual.

Before using the monitor, you must familiarize yourself with all warnings and cautions, with the steps to power up the monitor, and with the sections of this directions for use that pertain to your use of the monitor.

- Failure to understand and observe any warning statement in this manual could lead to patient injury, illness, or death.
- Failure to understand and observe any caution statement in this manual could lead to damage to the equipment or other property, or loss of patient data.

## General warnings and cautions



**WARNING** Many environmental variables, including patient physiology and clinical application, can affect the accuracy and performance of the monitor. Therefore, you must verify all vital signs information before treating the patient. If there is any question about the accuracy of a measurement, verify the measurement using another clinically accepted method.



**WARNING** Alarm limits are patient-specific. For alarms to function properly, you must set or verify alarm limits appropriate for each patient. Each time the monitor is powered on, you must check that the alarm settings are appropriate for your patient before you start monitoring.



**WARNING** The monitor is not intended for use during patient transport outside of the medical facility. Do not use the monitor to take measurements on any patient in transit.



**WARNING** Do not use the monitor as an apnea monitor.



**WARNING** Use only Welch Allyn approved accessories, and use them according to the manufacturer's directions for use. Using unapproved accessories with the monitor can affect patient and operator safety and can compromise product performance and accuracy.



**WARNING** Inaccurate measurement risk. Do not connect more than one patient to a monitor.



**WARNING** Inaccurate measurement risk. Dust and particle ingress can affect the accuracy of blood pressure measurements. Use the monitor in clean environments to ensure measurement accuracy. If you notice dust or lint build-up on the monitor's vent openings, have the monitor inspected and cleaned by a qualified service technician.



**WARNING** Inaccurate measurement risk. Liquids and excessive moisture can damage patient sensors and cause them to perform inaccurately or fail.



**WARNING** Patient harm risk. Always remove sensors from patients and disconnect them completely from monitors before bathing.



**WARNING** Liquids can damage electronics inside the monitor. Prevent liquids from spilling on the monitor.  
If liquids are spilled on the monitor:

1. Power down the monitor.
2. Disconnect the power plug.
3. Remove battery pack from the monitor.
4. Dry off excess liquid from the monitor.

**Note** If liquids possibly entered the monitor, remove the monitor from use until it has been properly dried, inspected, and tested by qualified service personnel.

5. Reinstall battery pack.
6. Power on the monitor and verify that the monitor functions normally before using it.

If liquids enter the printer housing:

1. Power down the monitor.
2. Disconnect the power plug.
3. Remove battery pack from the monitor.
4. Remove and discard the paper roll.
5. Clean and dry the inside of the printer housing.

**Note** The printer housing has a drain tube that directs liquids down and out the bottom of the monitor. If liquids possibly entered other openings in the monitor, remove the monitor from use until it has been properly dried, inspected, and tested by qualified service personnel.

6. Install a new roll of paper.
7. Power on the monitor and verify that the monitor functions normally before using it.



**WARNING** Safety risk and potential shock hazard. Cords, cables, and accessories damaged from prior misuse can affect patient and operator safety. Inspect all cords, cables, and accessories for strain relief wear, fraying, or other damage according to the recommendations presented in the Maintenance and service section of this manual. Replace as necessary. Inspect the AC cord for exposed copper before touching the cord. Unplug the AC cord only by pulling on the plug, never the cord. Never lift the monitor by the power cord or patient connections.



**WARNING** Fire and explosion hazard. Do not operate the monitor in the presence of a flammable anesthetic mixture with air, oxygen, or nitrous oxide; in oxygen-enriched environments; or in any other potentially explosive environment.



**WARNING** Fire and shock hazard. Only connect LAN cables contained within the perimeter of a single building. Conductive LAN cables spanning multiple buildings may introduce fire or shock hazards unless they are fitted with fiber optic cables, lightning arrestors, or other applicable safety features.



**WARNING** The monitor may not function properly if dropped or damaged. Protect it from severe impact and shock. Do not use the monitor if you notice any signs of damage. Qualified service personnel must check any monitor that is dropped or damaged for proper operation before putting the monitor back into use.



**WARNING** Defective batteries can damage the monitor. If the battery shows any signs of damage or cracking, it must be replaced immediately and only with a battery approved by Welch Allyn.



**WARNING** Improper disposal of batteries may create an explosion or contamination hazard. Never dispose of batteries in refuse containers. Always recycle batteries according to local regulations.



**WARNING** Electric shock hazard. Do not open the monitor or attempt repairs. The monitor has no user-serviceable internal parts. Only perform routine cleaning and maintenance procedures specifically described in this manual. Inspection and servicing of internal parts shall only be performed by qualified service personnel.



**WARNING** Inaccurate measurement risk. Do not expose to temperatures higher than 122° F (50° C).



**WARNING** Inaccurate measurement risk. Do not use the monitor on patients who are on heart-lung machines.



**WARNING** Inaccurate measurement risk. If using patient sensors during full body irradiation, keep the sensor out of the irradiation field. If the sensor is exposed to the irradiation, the reading might be inaccurate or the monitor might read zero during the active irradiation period.



**WARNING** Use the monitor only as described in this directions for use. Do not use the monitor on patients as described in the Contraindications.



**WARNING** Inaccurate measurement risk. Do not use the monitor on patients who are experiencing convulsions or tremors.



**WARNING** Personal/patient injury risk. Wall-mounted equipment and accessories must be installed in accordance with accompanying instructions. Improper installation can result in the monitor falling off the wall and injuring someone. Welch Allyn is not responsible for the integrity of any installation not performed by authorized Welch Allyn service personnel. Contact an authorized Welch Allyn service representative or other qualified service personnel to ensure professional installation for safety and reliability of any mounting accessory.



**WARNING** Do not place the monitor in any position that might cause it to fall on the patient.



**WARNING** Welch Allyn is not responsible for the integrity of a facility's power. If the integrity of a facility's power or protective earth conductor is in doubt, always operate the monitor on battery power alone when it is attached to a patient.



**WARNING** Avoid continuously monitoring a patient when the device is operating on battery power. If only battery power is available, you must remain in the room with any patient whose vital signs are being monitored continuously. Actively monitor both patient and battery status to ensure patient safety.



**WARNING** Patient harm and equipment damage risk. Carefully route patient cabling to reduce the possibility of patient entanglement or strangulation. When transporting the monitor on a mobile stand, properly secure all patient cables and cords to keep them clear of the wheels and to minimize trip hazards.



**WARNING** For operator and patient safety, peripheral equipment and accessories that can come in direct patient contact must comply with all applicable safety, EMC, and regulatory requirements.



**WARNING** All signal input and output (I/O) connectors are intended for connection of only devices complying with IEC 60601-1, or other IEC standards (for example, IEC 60950), as applicable to the monitor. Connecting additional devices to the monitor may increase chassis or patient leakage currents. To maintain operator and patient safety, consider the requirements of IEC 60601-1-1. Measure the leakage currents to confirm that no electric shock hazard exists.



**WARNING** Equipment failure and patient harm risk. Do not cover the air intake or exhaust vents on the rear and base of the monitor. Covering these vents could cause overheating of the monitor or muffling of alarms.



**WARNING** This equipment is not suitable for use in the presence of electro-surgery.



**WARNING** Cross-contamination or nosocomial infection risk. Clean and disinfect the monitor on a routine basis according to your facility's protocols and standards or local regulations. Thorough hand-washing before and after contact with patients greatly reduces the risk of cross-contamination and nosocomial infection.



**WARNING** For patient safety, do not use the monitor or any accessory during MRI scanning. Induced current could cause burns.



**WARNING** When the monitor is not connected to a secondary alarm system during continuous monitoring, check the monitor regularly to receive patient data, alarms, and alerts.



**CAUTION** United States Federal law restricts this monitor to sale, distribution, or use by or on the order of a physician or licensed healthcare professional.



**CAUTION** Electromagnetic interference risk. The monitor complies with applicable domestic and international standards for electromagnetic interference. These standards are intended to minimize medical equipment electromagnetic interference. Although this monitor is not expected to present problems to other compliant equipment or be affected by other compliant devices, interference issues still may occur. As a precaution, avoid using the monitor in close proximity to other equipment. In the event that equipment interference is observed, relocate the equipment as necessary or consult manufacturer's directions for use.



**CAUTION** Use only a Class I (grounded) AC power supply cord for powering this monitor.



**CAUTION** Do not use a long press of  $\frac{1}{2}$  to power down the monitor when it is functioning normally. You will lose patient data and configuration settings.



**CAUTION** Never move the monitor or mobile stand by pulling on any of the cords as this may cause the monitor to tip over or may damage the cord. Never pull on the power cord when removing it from the power outlet. When disconnecting the power cord, always grasp the attachment plug and not the cord. Keep the cord away from liquids, heat, and sharp edges. Replace the power cord if the strain relief or cord insulation is damaged or begins to separate from the attachment plug.



**CAUTION** Use only the Welch Allyn USB client cable to connect a laptop computer to the USB client port. Any laptop connected to the monitor must be running on a battery, a 60601-1-compliant power supply, or a 60601-1-compliant isolation transformer. While monitoring a patient, you can only charge the laptop battery if it is connected to 60601-1-compliant, isolated AC power.



**CAUTION** If the touchscreen is not responding properly, refer to the troubleshooting section. If the problem cannot be resolved, discontinue use of the monitor and contact an authorized Welch Allyn service center or qualified service personnel.



**CAUTION** Verify patient identity on the monitor after manual or barcode entry and before printing or transferring patient records.



**CAUTION** Keep the monitor outside of MRI suites and any areas marked for high magnetic or electric field strength.



## Physical design

---

The monitor is available in two sizes: standard and extended. The primary difference between these models is the number of parameters they support.

**Note** Your monitor, based on size or configuration, might not contain all parameters or features illustrated in this section.

In a standard monitor, up to two parameter modules are installed on the left side. You can tell which modules are installed based on the connectors visible on the outside of the device. The following image shows a standard monitor with pulse-oximetry and blood-pressure modules.

### Standard monitor left side

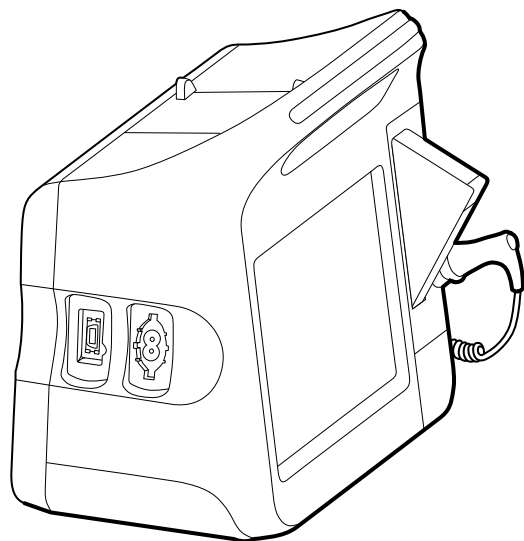

The extended version can have a maximum of three modules (such as CO2, pulse oximetry, and blood pressure) on the left side.

**Extended monitor left side**

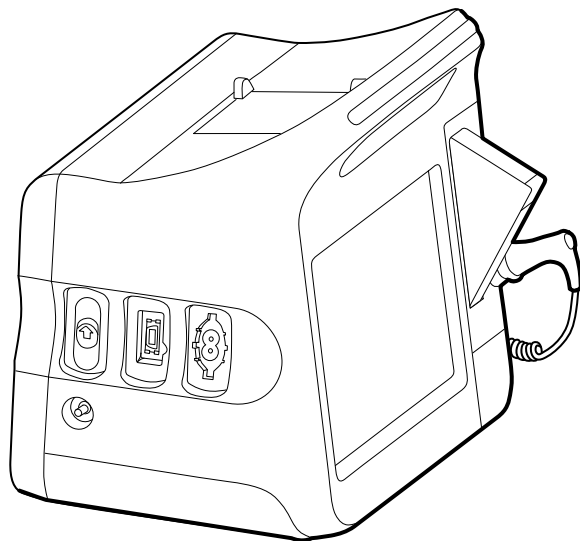

Equipment setup and basic monitor functions are the same for both models, unless otherwise noted in the directions for use.

## Controls, indicators, and connectors

The following diagrams show a full-featured monitor. Your monitor, based on size or configuration, might not contain all of these features.

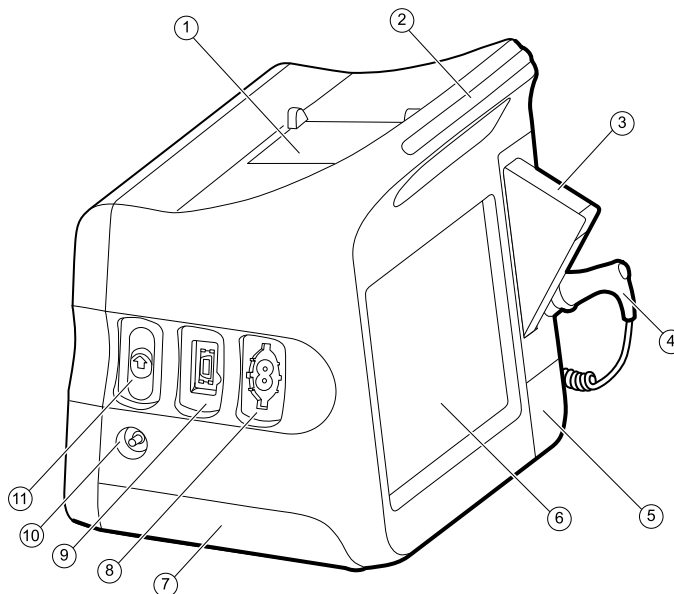

No.	Feature	Description
1	Printer	Printer provides a printout of patient and device information.



No.	Feature	Description
2	Light bar	Provides a visual alarm with red and amber LEDs.
3	Thermometry	Temperature probe cover box.
4	Thermometry	Temperature probe.
5	Thermometry (connector behind cover)	Secures the probe connection to the monitor.
6	LCD screen	1024 x 600 pixels color touchscreen provides a graphical user interface.
7	Battery compartment (behind cover)	Houses the lithium-ion battery.
8	Blood pressure	Supports dual-lumen or single-lumen hoses.
9	Pulse oximetry	Nellcor or Masimo rainbow SET module. The Nellcor module measures SpO2 and pulse rate. The Masimo module measures SpO2, pulse rate, SpHb, and RRa.
	<b>Note</b>	SpHb and RRa are optional parameters.
	<b>Note</b>	Monitors configured with RRa cannot be configured with CO2.
10	CO2	CO2 sampling exhaust port.
11	CO2	CO2 sampling input connector (behind cover).

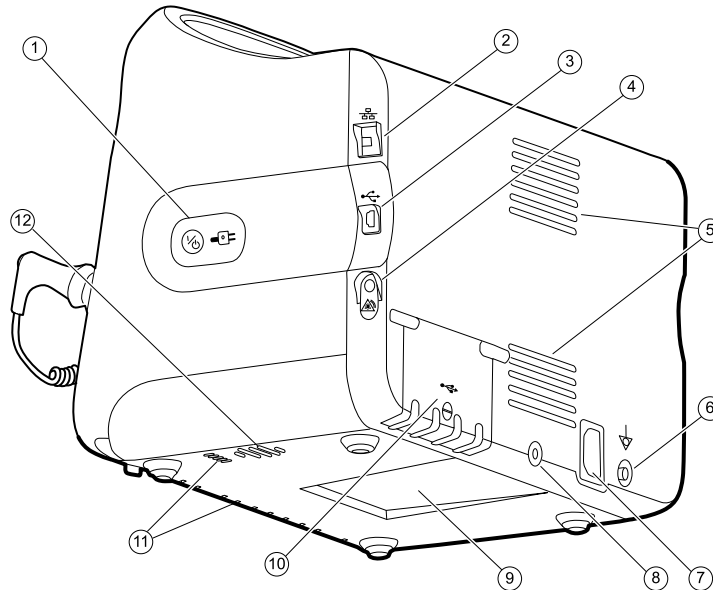

No.	Feature	Description
1	Power switch and LED	Power-on/Standby switch. The LED indicates the charging status when the monitor is connected to AC power:

No.	Feature	Description
		<ul style="list-style-type: none"><li>• Green: The battery is charged.</li><li>• Amber: The battery is charging.</li></ul>
2	Ethernet RJ-45	Provides a hardwired connection to the computer network.
3	USB client	Provides a connection to an external computer for testing and software upgrades.
4	Nurse call	Provides a connection to the hospital nurse call system. (Not available on the 6300 model.)
5	Fan exhaust	
6	Ground lug (equipotential terminal)	Provided for electrical safety testing and as a means for connection of a potential-equalization conductor.
7	Power connection	Provides an external AC power connection.
8	Mobile stand mounting hardware	Secures the mounting plate to the monitor.
9	Recess for mounting plate	Secures the monitor when the monitor is mounted on the mobile stand or wall.
10	USB connector door	Provides access to host USB connections for optional accessories.
11	Fan intake	
12	Speaker	Provides tones. A piezo beeper inside the monitor provides backup.

# Setup

---

## Supplies and accessories

For a list of all approved supplies and accessories, see *Approved Accessories* on your CD.

## Insert the battery

This procedure applies to first-time setup of the monitor.



**WARNING** Risk of fire, explosion, and burns. Do not short-circuit, crush, incinerate, or disassemble the battery pack.

1. Turn the monitor upside down to access the battery cover.
2. Locate the battery cover, indicated by .
3. Insert a coin into the slot and push to open. Choose a coin that fits comfortably into the slot.

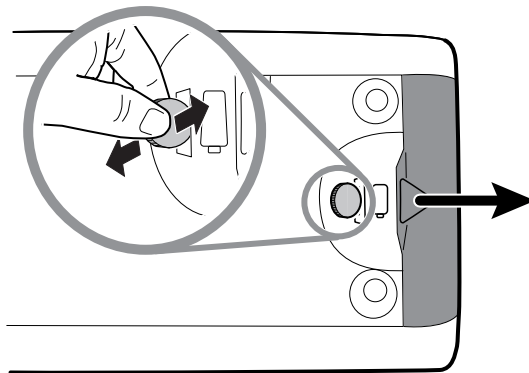

4. Slide in the battery.

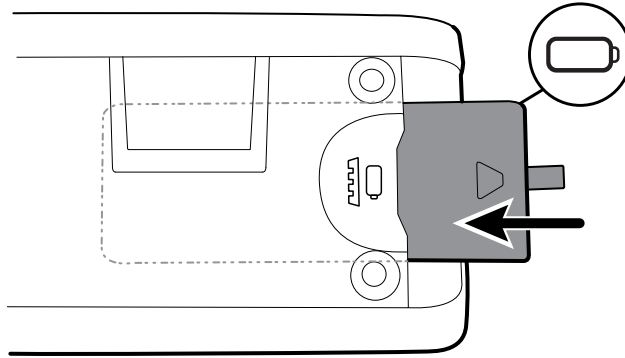

**Note** Do not remove the tab label from the battery. This tab helps you remove the battery from the compartment when you need to replace it.

5. Replace the battery cover by inserting one end into the notched access and then pressing firmly on the opposite end.

**Note** New batteries are only 30 percent charged. Therefore, connect the monitor to AC power immediately after inserting a new battery.

## Mount the monitor

You can install the monitor on a mobile stand or on an interior wall equipped with a Welch Allyn-approved wall-mount fixture.

## Check the mounting bracket

Before you mount the monitor, make sure the stand or wall-mount fixture has the mounting bracket designed for your monitor. Monitors with a standard housing require a small bracket. Monitors with an extended housing require a large bracket.

### Small bracket for standard housing

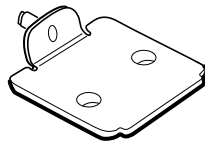

### Large bracket for extended housing

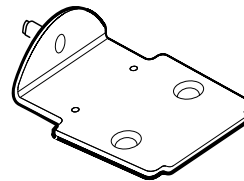

**Note** If your monitor has an extended housing but the small bracket is installed on your stand or wall-mount fixture, you must replace the small bracket with the large bracket. Follow the steps presented in the *Mounting Bracket Replacement Install Guide* shipped with the large bracket, and then proceed to mount the monitor.

## Mount the monitor on a stand

1. Align the monitor on the mounting bracket in the center of the stand tray. Slide the monitor into place, catching the bracket in the guides on the bottom of the monitor.
2. Ensure that the monitor is properly seated on the bracket. If you can raise either side of the monitor off the stand, it is not seated properly. Repeat step 1 until the monitor is mounted correctly.
3. Tighten the screw on the bracket into the screw hole on the back of the monitor.

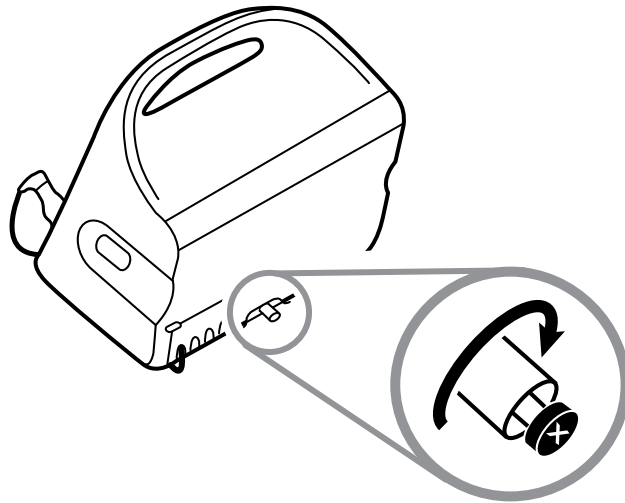

## Mount the monitor on the wall

For mounting instructions, see the wall mount manufacturer's directions for use.

## Attach the probe well

1. Align the probe well with the tabs facing up and down and insert the probe well into the temperature module.

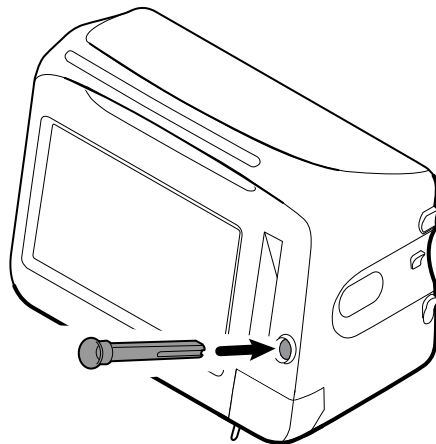

The probe well snaps into place when it is fully seated.

2. Insert the temperature probe into the probe well.

## Attach the temperature probe



**CAUTION** The temperature module only operates with the probe well properly in place.

1. Remove the cover of the temperature module by pressing the tab on the bottom and sliding the cover to the right. The cover is located at the bottom-right of the monitor, below the probe well.

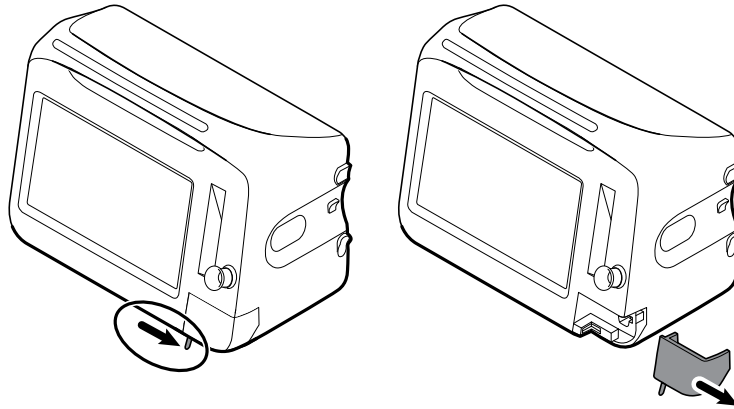

2. Hold the temperature probe cable connector with the spring tab on the right and insert it into the probe port of the temperature module.

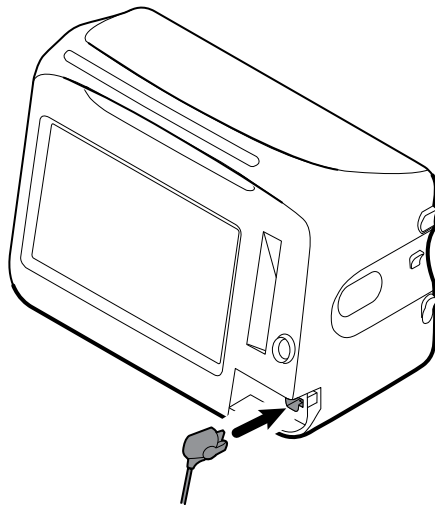

3. Push it into place until it clicks.
4. Reattach the cover. Use the alignment tab and slide the cover to the left to click it back into place.

## Remove the temperature probe and well

Follow these steps to disconnect the probe cable and remove the probe well.

1. Remove the cover of the temperature module by pressing the tab on the bottom and sliding the cover to the right. The cover is located at the bottom-right of the monitor, below the probe well.

2. Depress the spring tab on the temperature probe cable connector and withdraw it from the probe port.
3. Reattach the cover. Use the alignment tab and slide the cover to the left to click it back into place.

Grasp the probe well and pull it up to remove it from the monitor.

## Connect the NIBP hose

1. Place your thumb and forefinger on the hose connector and squeeze the side tabs.
2. Align the hose connector with the hose connector port on the side of the monitor.

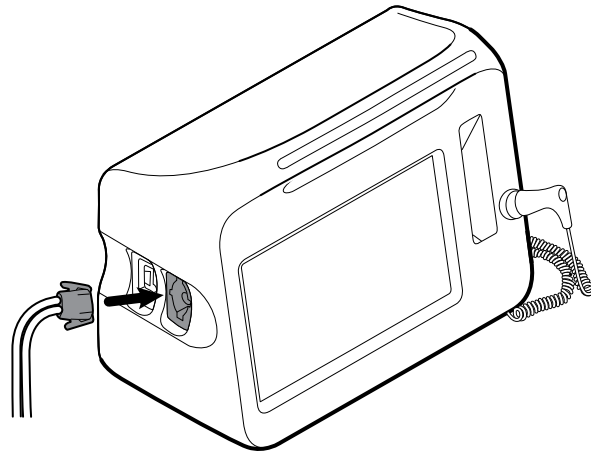

3. Insert the hose connector, pressing firmly until it clicks into place.

## Disconnect the NIBP hose

1. Place your thumb and forefinger on the hose connector.

**Note** Always grasp the hose by the connector. Do not pull on the hose itself.

2. Squeeze the side tabs until the connector releases.
3. Pull the connector away from the connector port.

## Connect the SpO2 cable or the SpO2/RRa dual cable



**WARNING** Patient injury risk. Do not use a damaged sensor or pulse oximetry cable or a sensor with exposed electrical or optical components.

Follow these steps to connect the SpO2 cable or the SpO2/RRa dual cable to the SpO2 port on the monitor. The location of the port on your monitor might differ from that shown in the images below.

**Note** For monitors configured with SpHb, the sensor used to monitor SpHb also measures SpO2.

### Connect the SpO2 cable

1. Place your thumb and forefinger on the cable connector and squeeze the side tabs.

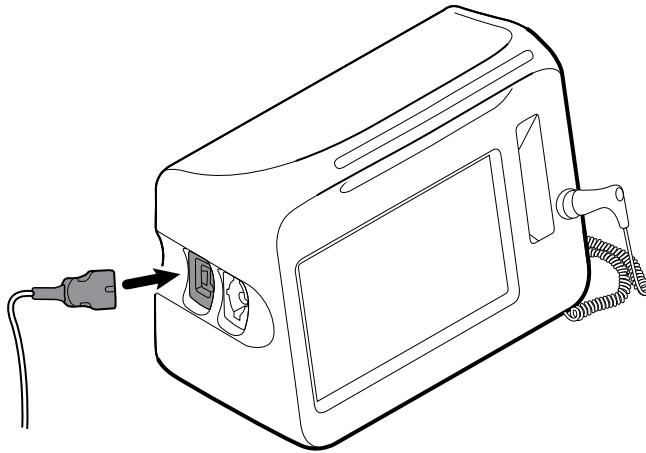

2. Align the cable connector with the cable connector port.
3. Insert the cable connector, pressing firmly until it clicks into place.

### Connect the SpO2/RRa dual cable

**Note** Monitors configured to measure acoustic respiration (RRa) require a dual cable as shown below. The dual cable has two ports, one for the SpO2 cable and the other for the RRa cable.

1. Connect the dual cable to the device as shown in the preceding steps. (The connector is the same as for the standard SpO2 cable.)

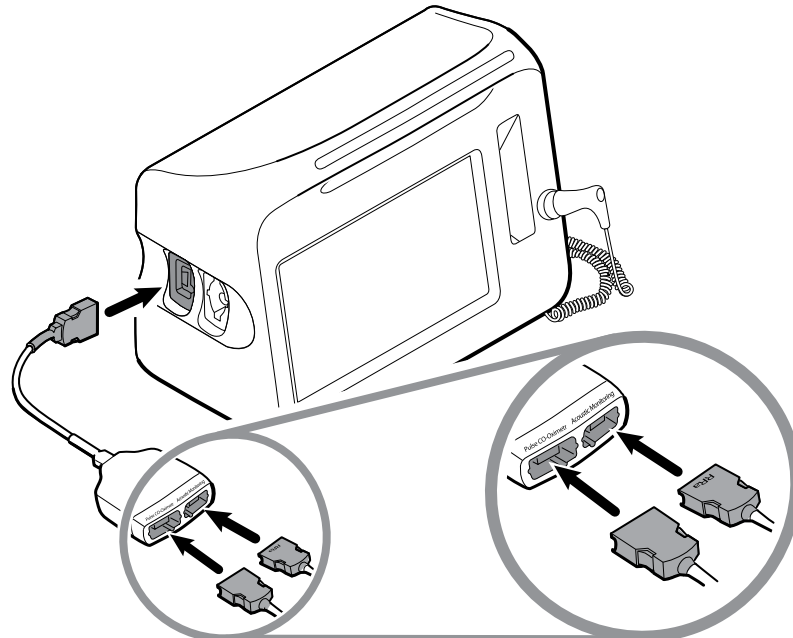

2. Connect the SpO2 cable to the Pulse CO-Oximetry port (the larger of the two ports with the red background).
3. Attach the RRa patient cable to the Acoustic Monitoring port (the smaller of the two ports with no colored background). See the dual cable manufacturer's directions for use for more information.



- Note** Labels appear on both the top and bottom of the dual connector as well as on the patient cables to help ensure proper connection of the patient cables to the dual cable.
- Note** Typically, a clinician will connect the single-use RRa sensor to the RRa patient cable at the start of acoustic respiration monitoring. See the sensor manufacturer's directions for use for more information. Also see the Acoustic Respiration rate (RRa) section of this directions for use.

## Disconnect the SpO2 cable or the SpO2/RRa dual cable

1. Place your thumb and forefinger on the cable connector.

**Note** Always grasp the cable by the connector. Do not pull on the cable itself.

2. Squeeze the side tabs until the connector releases.
3. Pull the connector away from the connector port.

## Attach a USB accessory



**CAUTION** Accessories attached to this monitor must run on battery power. Do not use any accessory's external power supply when it is attached to the monitor.

1. On the rear of the monitor, loosen the screw on the USB door and open it.

**Note** On some monitor stands, the monitor mounting bracket partially overlaps the USB door. If you observe this overlap, loosen the screw on the monitor mounting bracket and shift the monitor forward just enough on the bracket to open the USB door, then slide the monitor back on the mounting bracket.

2. Attach each accessory's USB cable into an unused USB port on the monitor. See the accessory's directions for use for any special instructions.



**CAUTION** Connect cables in a manner that minimizes entangling.

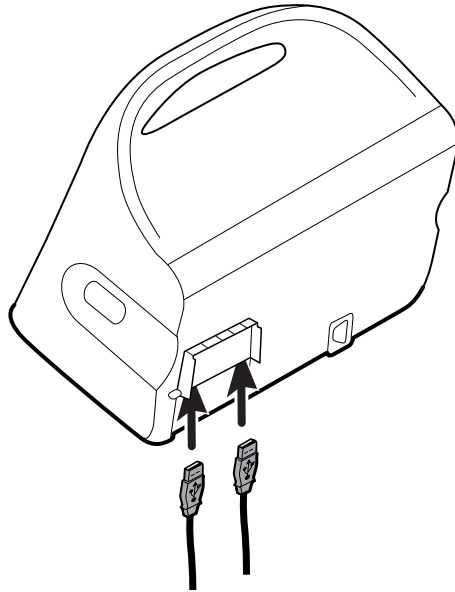

3. Close the door and tighten the screw.

**Note** If you loosened the monitor mounting bracket in order to open the USB door, shift the monitor forward on the bracket as you did in step 1, close the door, and then slide the monitor back into its mounted position. Ensure that the monitor is seated firmly on the bracket, then tighten the screw on the bracket into the screw hole on the back of the monitor. (See "Mount the monitor on a stand" in this section for more detail.)

**Note** Some accessories require a license to enable them for use. These accessories are packaged with an authorization code and instructions for activating the license using the Welch Allyn Service Tool. For more information, refer to the instructions and the service tool installation guide.

## Detach a USB accessory

1. On the rear of the monitor, loosen the screw on the USB door and open it.
2. Detach the accessory's USB cable from USB port on the monitor.
3. Close the door and tighten the screw.

## Insert a new roll of paper

The printer is located on the top of the monitor. Follow these steps to insert the roll of printer paper:

1. Grasp the two tabs on the printer door and pull up to open.
2. Insert a new roll of paper.

**Note** The paper roll must be installed so that it unwinds from the bottom of the roll, as illustrated. If the paper roll is not installed correctly, the printer will not print properly.

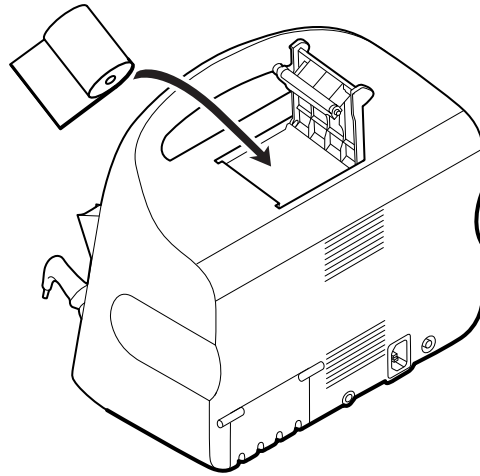

3. Advance the end of the roll past the roller so that it extends past the printer door, as shown.

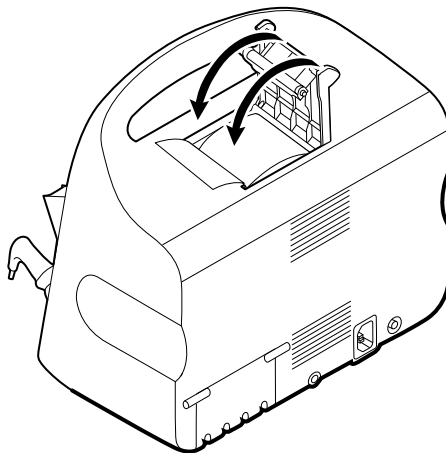

4. With one hand, pull lightly on the paper to take up any slack. With the other hand, close the printer door by pushing it down and into place until it clicks.

Be certain that the paper does not catch in the printer door.

## Connect AC power

You can use the monitor with AC or battery power (after fully charging the battery).



**WARNING** Shock hazard. Inspect the AC cord for exposed copper before touching the cord.



**CAUTION** During continuous monitoring, keep the monitor connected to AC power at all times. If only battery power is available, you must remain in the room with any patient whose vital signs are being monitored continuously. Actively monitor both patient and battery status to ensure patient safety.

1. Insert the power cord into the AC power connector port on the back of the monitor.

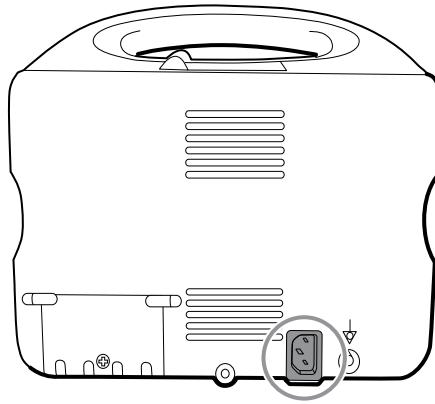

2. Insert the power plug into an electrical outlet to power the monitor and to charge the battery.

## Disconnect AC power

Carefully grasp the power plug and disconnect it from the power outlet. To avoid damaging the power cord, do not pull on the cord itself.

# Startup

---

## Power

The power button, located on the side of the monitor, performs the following functions:

- Powers up the monitor
- Sets the monitor into Display power-saving mode, except when an alarm condition is active (brief press)
- Resets the monitor (press and hold for 6 seconds)



**CAUTION** Do not use a long press of  to power down the monitor when it is functioning normally. You will lose patient data and configuration settings.

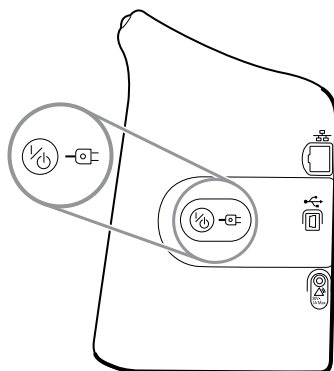

The LED in the center of the power plug symbol indicates the battery charging status:

- Green indicates that AC power is present and that the battery is fully charged.
- Amber indicates that AC power is present and that the battery is charging.

The monitor has distinct power states.

### Monitor on

The monitor is operating on battery power or AC power. You can utilize the monitor's features, and the display is active.

### Display power-saving mode

The monitor is operating on battery or AC power, but the display is off to conserve power. A brief press of the power button sets the monitor into Display power-saving

mode from the active state. Settings for this mode can be changed in the Advanced Settings Display tab.

Battery-powered accessories connected to the monitor continue to charge while the monitor is in this mode and connected to AC power.

**Note** The monitor will not enter the Display power-saving mode while an alarm condition is active or when NIBP intervals are in progress. In addition, the monitor will exit this mode if an alarm occurs.

The following actions will return the monitor display to the active state:

- Touch the screen
- Remove the temperature probe from the probe well
- Attach the SpO2 sensor to a patient
- Attach a sampling line to a patient
- Press 

## Power up the monitor

The monitor runs a brief diagnostic self-test each time it powers up.



**WARNING** Equipment failure risk. The monitor includes a fan that circulates air through the device. If the fan does not run when you power up the device, remove it from use and inform qualified service personnel immediately. Do not use the monitor until the problem is corrected.



**WARNING** To ensure patient safety, listen for two audible indicators (a piezo beeper and a speaker tone) and watch for visual alerts at power-up at least once daily. Correct any system errors before using the monitor. In addition to the audible indicators, the monitor LED light bar illuminates to alert you of alarms. Amber indicates a low-level alarm. Flashing amber indicates a medium-level alarm. Flashing red indicates a high-level alarm.



**WARNING** Always observe the monitor during power-up. If any display fails to illuminate properly, or if a system fault code or message displays, inform qualified service personnel immediately, or call your nearest Welch Allyn Customer Service or Technical Support facility. Do not use the monitor until the problem is corrected.



**CAUTION** Always use the monitor with an adequately charged and properly functioning battery.



**CAUTION** During continuous monitoring, keep the monitor connected to AC power at all times.





**CAUTION** Use only a Class I (grounded) AC power cord for powering this monitor.

1. Press  to power up the monitor.

Following a successful self-test, the monitor displays the Welch Allyn logo, the LED light bar (located on the handle) flashes, and a power-up tone sounds. The startup screen then appears with the following banner across the bottom.



If a system error is detected, the monitor becomes inactive until you press  or until the monitor shuts down automatically. The monitor displays a system fault message that contains a wrench icon  and a system fault code to aid service personnel and engineers in diagnosing the problem.

**Note** If patient data was saved during the most recent power down, a Confirm patient and location dialog appears with the following options:

- Same patient and location
- Same patient, new location
- New patient

2. If the Confirm patient and location dialog appears, select the desired option and touch **OK**.

## Power down the monitor

1. Touch the **Settings** tab.
2. Touch the **Device** tab.
3. Touch **Power down**.

This power-down method ensures that patient measurements are retained in the monitor memory for a maximum of 24 hours. (These saved measurements are available for recall, printing, or to send electronically to the network.) This method also ensures that any configuration settings you have changed and saved will be maintained at the next startup.

**Note** If the monitor is in the Continuous Monitoring profile, a Power down options dialog appears with the following options:

- Save patient data on the device with a temporary Patient ID
- Remove patient data from the device

4. If the Power down options dialog appears, select the desired option and then touch **Power down**.

**Note** If your monitor is configured with a Braun thermometer, avoid powering down the monitor between patient measurements to help maintain an adequate charge to the Braun dock.

## Reset the monitor

If the monitor stops functioning, you can press and hold  for approximately 6 seconds to allow the hardware to completely cycle off and to reset the monitor configuration settings to the last saved default power-up configuration. The button is located on the side of the monitor.



**CAUTION** Do not use a long press of  to power down the monitor when it is functioning normally. You will lose patient data and configuration settings.

## Set the date and time

1. Touch the **Settings** tab.
2. Touch the **Device** tab.
3. Touch the **Date/Time** vertical tab.
4. To change the date and time values: Touch the up and down arrow keys or touch  and enter a value.

Repeat for each value you want to change.

**Note** The date and time stamps on saved patient measurements will adjust in response to new date and time settings.

## Enter clinician information

1. Go to the Clinician tab using one of these methods:
  - On the Home tab, touch the Clinician ID section of the Device Status area (top left corner of the screen).
  - Touch the **Settings > Clinician** tab.
2. To enter the clinician name, touch , located at the right of the text field, and enter characters.
 

You can enter up to 32 characters for the clinician's first and last name. Enter only 1 character for the middle initial.
3. To enter the clinician ID, use one of these methods:
  - Touch  and enter the ID.
  - Scan the clinician's barcode with a barcode scanner. The scanned ID appears in the field.
4. If prompted, enter your system password in the Authentication pane.
5. Touch **OK** to save your entries and return to the Home tab.

## Set the default configuration

1. Enter or adjust the settings you want to add or change on the device.
 

**Note** The new settings appear as they are completed but are temporary until they are saved.
2. Touch the **Settings** tab.
3. Touch the **Device** tab.
4. Touch the **Defaults** vertical tab.
5. Touch **Save as default**.



6. Touch **OK** to confirm that you want to overwrite your previous settings and replace them with your current settings in the default startup configuration. Or touch **Cancel** to retain the previous settings.

The new settings are stored as the default startup settings once you restart the monitor.

**Note** To enable or disable this control, navigate to the Device tab in Advanced settings and select or deselect **Enable save as default**. (This requires the Advanced settings access code.)

**Note** If the device is connected to Connex CS, the date and time settings are synchronized with the Connex CS settings.

**Note** The date and time stamps on saved patient measurements will adjust in response to new date and time settings.



# Navigation

The monitor screen provides the interface that you use to complete your workflow. You access the monitor's features by touching the screen.

## Home tab

The Home tab includes the following areas:

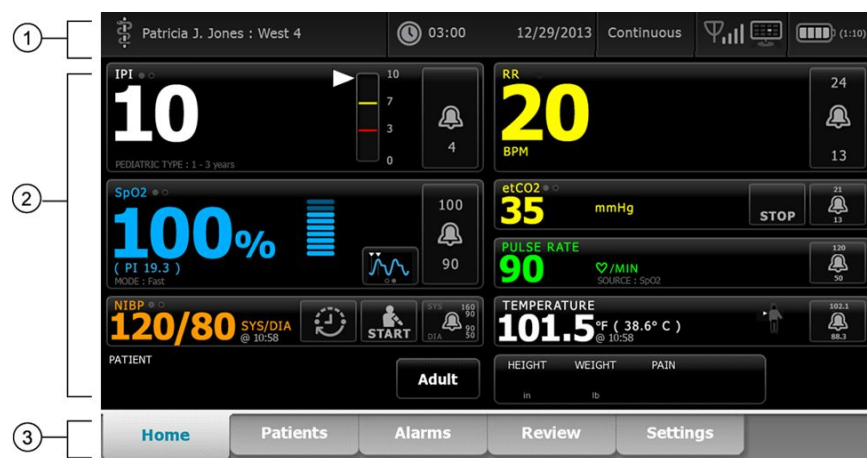

Item	Area
1	Device Status
2	Content
3	Navigation



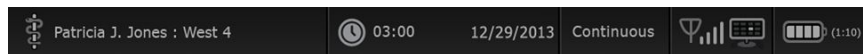



## Device Status area



The Device Status area, located at the top of the Home screen, displays the following monitor information, from left to right:

- Clinician identification. The format can be a name, ID number, or icon. Touch this area to navigate to the Clinician login.
- Device location.

- Time and date. Touch this area to navigate to date and time settings.
- Current profile. Touch this area to navigate to the Profiles vertical tab (on the Device tab), which displays available profiles.
- Connection status (wired or wireless, and central station). The icons indicate which connections, if any, are currently attempted or active.

Icon	Connection type or indicator
	Ethernet
	USB
	Wireless
	Wireless signal strength
	Attempting to connect to the central station
	Connected to central station
	Not connected to central station
Blank	No connection

- Battery condition. Estimated battery capacity is displayed in hour(s):minute(s) format. Touch this area to navigate to the Device tab, where you can power down the device.

This area also provides interactive alarm and information messages, including a Demo mode active indicator.

## Battery status

The battery status indicator displays the state of the battery.

The battery status is represented by icons in the right corner of the Device Status area:

- The monitor is connected to a power outlet and the battery is charging or is fully charged. The estimated charge rate is displayed as a percentage of capacity.

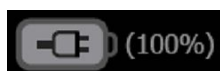

- The monitor is not connected to a power outlet and is running on battery power. The estimated charge time remaining is displayed in the hour(s):minute(s) format. Each section of the battery status indicator represents a percentage of remaining charge.



- The monitor is connected to a power outlet but the battery does not maintain a charge or has been removed.



When the battery is not being recharged and power becomes low, a very low-priority alarm appears in the Device Status area.



**Note** Observe the remaining battery charge in the battery status indicator and plug the monitor into a power outlet as soon as you are able.

If the very low-priority alarm is dismissed or if you take no action to charge the battery, a high-priority alarm appears when battery power is critically low. Plug the monitor into a power outlet immediately to prevent it from powering down.



Failure to plug in the monitor before the remaining charge runs out causes the monitor to power down and lose all unsaved data.

## Alarm and information messages

The Device Status area provides alarm and information messages that are either temporary or exist as long as the condition to which the message applies remains. Alarm or information messages may also include controls and/or behavior that you can use to manage alarm and information messages.

When the monitor detects an alarm condition, an alarm message appears. When multiple alarms occur, the device provides options to manually toggle or autoscroll through a stack of messages. You can cycle through each alarm message in sequence of priority by touching the multiple alarm toggle. Alternatively, the autoscroll option displays messages in the stack for approximately 4 seconds. These messages are stacked in order of priority: the monitor displays the highest priority messages first followed by each successive alarm message in order of priority. After presenting the entire stack of alarm messages, the autoscroll feature loops back to the top priority message and repeats the entire stack unless specific alarms auto-dismiss or you reset or cancel specific alarms. In both the manual toggle and autoscroll options, when multiple alarm messages of the same priority exist at the same time, the device displays the most recent of those alarm messages first.

Information messages instruct you to interact with the monitor in a specific way or provide information that does not require action. You can dismiss an information message by selecting the control associated with the message or waiting for the message to time out. Information messages rank the lowest in priority.

When the monitor is operating in Demo mode, which requires access to Advanced settings, the Device Status area displays an information message indicating that the Demo mode is active, as shown below.



Any alarm messages that occur in Demo mode include a clear "DEMO MODE:" prefix as well.



## Content area

The Content area displays current vital sign measurements and patient identification. It also provides relevant controls.

The Content area includes the following:

- A frame for each available parameter
- The Patient frame
- The Manual parameters frame (height, weight, pain, temperature, respiration, and BMI, depending on configuration)

In the Triage, Spot Check, and Intervals Monitoring profiles, the Content area also includes a Save button, which you use to manually save current measurements to the Review tab. If your monitor is connected to an external system, you can send these patient measurements to that external system as well. You can configure your monitor to automatically send these measurements any time you press Save, or you can navigate to the Review tab and then select specific records to send to the external system.

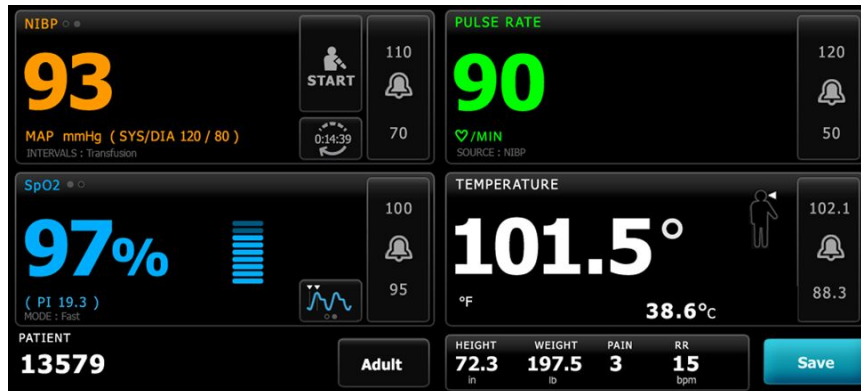

In the Continuous Monitoring profile, patient measurement data is automatically saved to the Review tab. Consequently, there is no Save button on the Home tab. If the monitor is connected to the Connex central station, the monitor automatically sends these patient measurements to the central station as well.



## Navigation area



The Navigation area includes the following tabs:

- **Home:** Displays vital-sign measurements and provides shortcuts to several controls.
- **Patients:** Accesses the patient list, patient summary, and manual parameters.
- **Alarms:** Accesses global alarm response and settings controls, plus alarm limit settings (available only in the Intervals Monitoring and Continuous Monitoring profiles).
- **Review:** Prints, deletes, and sends patient data.
- **Settings:** Accesses device configuration settings.

To navigate to a tab, touch the tab in the Navigation area with the corresponding name. The active tab is highlighted.

## Display lock

The display lock prevents clinician input, which may be useful when cleaning the display.

**Note** The lock feature is not a security mechanism.

The display locks when any of the following occur:

- You touch **Lock display now**.
- No interaction with the monitor occurs for the period specified in the Display tab. Use the Advanced tab to set or change the time it takes for the display to lock. (This requires the Advanced settings access code.)

## Lock the display

Follow these steps to touch the screen without activating the controls.

1. Touch the **Settings** tab.
2. Touch the **Device** tab.
3. Touch **Lock display now**.

The following occurs:

- The Home screen appears.

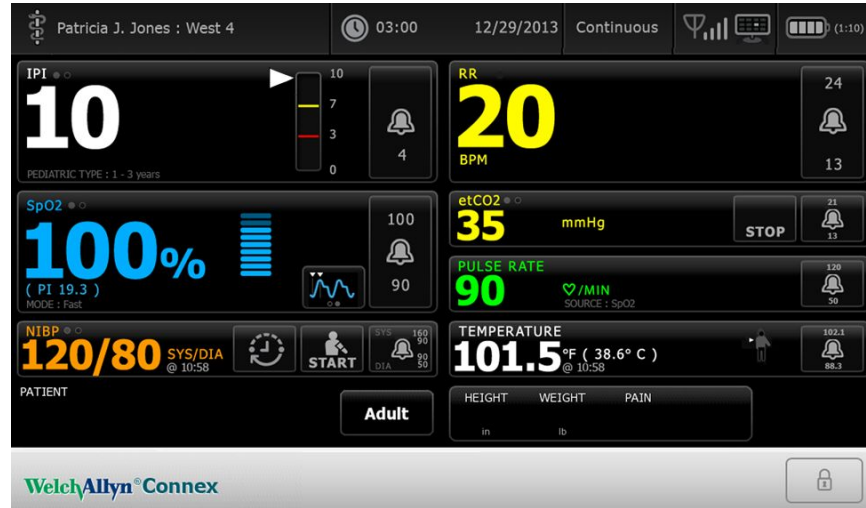

- A title bar with a lock icon (🔒) replaces the Navigation area at the bottom of the screen.
- Patient information no longer appears at the bottom left of the screen.
- All controls on the screen are locked, except for 🔒 on the title bar. If you select any area of the screen other than 🔒, a message appears.

## Unlock the display

On the locked screen, touch 🔒 in the title bar (located at the bottom of the screen).

The following occurs:

- Patient information appears in the Patient frame.
- The Navigation area appears.
- Home tab controls are available for use.

The display also unlocks when the following occur:

- An alarm condition.
- An externally initiated action, such as taking or stopping an NIBP measurement or upgrading software.
- Connecting a sampling line.



# Using the keypad, keyboard, and barcode scanner

---

## Open the numeric keypad



Touch any field that includes the numeric keypad icon .

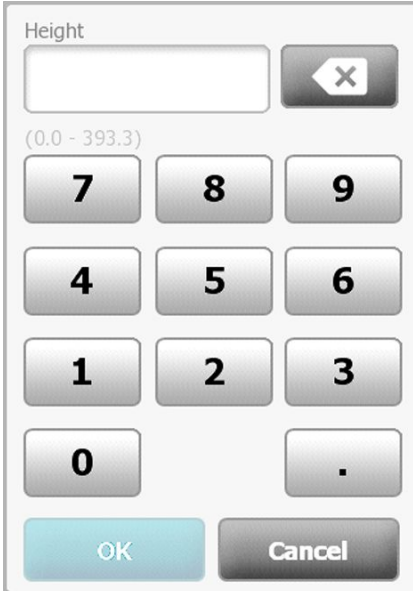

The numeric keypad appears.

## Numeric keypad



The numeric keypad includes the following components:

Component	Name	Description
	Data field	Displays the numbers you enter. The field name appears above and the range of values you can enter appears below this field.
	Backspace key	When touched, removes the rightmost number from the data field.

Component	Name	Description
	Cancel button	When touched, the numeric keypad disappears and the selected number does not change.
	OK button	When touched, the numeric keypad disappears and the entered number appears in the associated frame or data field.

## Enter a number

- With the numeric keypad open, touch a number or numbers.  
The value must be within the range that appears below the data field.
- Touch **OK**.
  - If the value is within the required range and format, the numeric keypad disappears and the entered numbers replace the previous numbers.
  - If the number is not within the required range and format, **OK** remains inactive until you enter a valid number.

## Close the numeric keypad

Touch one of the following:

- OK**: Exits the numeric keypad and inserts the number.
- Cancel**: Exits the numeric keypad without saving entered numbers.

## Open the keyboard







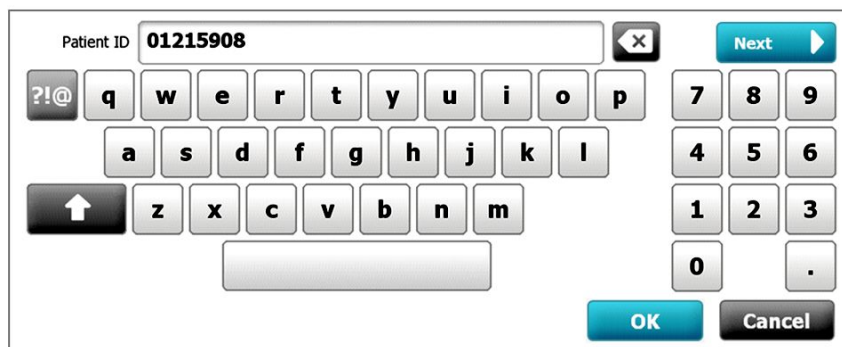



Touch any field that includes the keyboard icon .

The keyboard appears.

## Keyboard



The keyboard includes the following components:

Component	Name	Description
	Data field	Displays the characters you enter.
	Backspace key	When touched, removes the rightmost character from the data field.
	Space bar	When touched, enters a space in the data field.
	Shift key	When touched, enters the next letter as uppercase.
	Letters key	When touched, returns to the primary keyboard layout. The keyboard changes from normal layout when you touch one of these: <ul style="list-style-type: none"> <li>The symbols key</li> <li>The diacritical marks key</li> </ul>
	Symbols key	When touched, the keyboard displays symbols. The keyboard returns to its normal layout when you touch one of these: <ul style="list-style-type: none"> <li>Any symbol</li> <li>The letters key</li> <li>The symbols key</li> </ul> <p><b>Note</b> The symbols that display match the selected language.</p>
	Diacritical marks key (appearance varies in some languages)	When touched, the keyboard displays letters with diacritical marks. The keyboard returns to its normal layout when you touch one of these: <ul style="list-style-type: none"> <li>Any letter</li> <li>The letters key</li> <li>The diacritical marks key</li> </ul> <p><b>Note</b> This key appears only when the selected language uses diacritical marks.</p>
	Next button	When touched, accepts the entry for the current field, then clears the field to allow data entry for the next field.
	Cancel button	When touched, the keyboard disappears and the content of the data field remains the same.
	OK button	When touched, the keyboard disappears and the entered characters appear in the data field.

## Enter a letter or number

1. With the keyboard open, touch letters or numbers.
2. Do one of the following:
  - Touch **Next**. This control accepts the entry for the current field, then clears the data field to allow data entry in the next field.
  - Touch **OK**. The keyboard disappears and the entered characters appear in the data field.

## Enter a symbol or special character

**Note** To return to the keyboard's normal layout, touch .

1. With the keyboard open, touch . Symbols and special characters for the selected language appear.

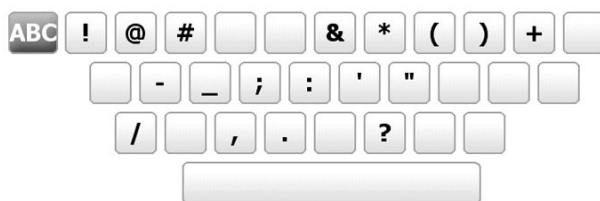



2. Touch the appropriate symbol or special character. The keyboard returns to its normal layout.



## Enter a diacritical mark

**Note** Keyboards with diacritical marks are available only for languages that use diacritical marks.

**Note** To return to the keyboard's normal layout without saving changes, touch



Diacritical marks key	Language(s)
None (Not applicable)	Danish, English, Dutch, German, Italian
	French
	Finnish, Norwegian, Spanish, Swedish
	Portuguese

Diacritical marks key	Language(s)
	Polish
	Greek

1. With the keyboard open, touch the diacritical marks key. This key varies based on the language, as noted above.

The keyboard displays diacritical marks for the selected language and therefore varies from one language to another. On each diacritical marks keyboard, the letters key in the top left corner returns you to the standard keyboard.

2. Touch a diacritical mark.

The keyboard returns to its normal layout.

## Close the keyboard

Touch one of the following:

- **Next:** Accepts the entry for the current field, then clears the field to allow data entry for the next field.
- **OK:** Exits the keyboard and inserts the data.
- **Cancel:** Exits the keyboard without saving entered data.

## Use a barcode scanner

The monitor enables the scanning of patients' and clinicians' barcodes to enter ID information. The barcode scanner supports linear and two-dimensional barcodes.

If you haven't done so already, attach the barcode scanner to the monitor. Use the instructions to attach an accessory.

**Note** Refer to the manufacturer's directions for use to ensure that the scanner is set to USB Com Emulation mode.

1. Remove the barcode scanner from its holder.
2. Hold the scanner approximately 6 inches (15.4 cm) from the barcode and squeeze the trigger so that the light from the scanner appears on the barcode.

Once the scanner completes a successful barcode reading, the ID appears in the targeted area (Patient frame, data field, or Device Status area). See additional notes below.

If the scanner has difficulty reading the barcode, slowly adjust the distance and the angle between the scanner and the barcode while squeezing the scanner trigger. If it continues to have difficulty, verify that the barcode is as flat as possible.

- Note** You can scan a patient's barcode from the Home tab or the Summary tab. The scanned ID appears in the Patient frame on the Home tab and in the Patient ID field on the Summary tab.
- Before you scan a barcode on the Summary tab, touch the keyboard icon in the Patient ID field. To return to the Home tab and begin taking patient measurements, touch **OK**.
- Note** Scanning a clinician ID while the Clinician ID pane is open places the scanned ID into the Clinician ID section of the Device Status area. Touch **OK** to return to the Home tab and to begin taking patient measurements.
- Note** Use the Advanced settings Data Management tab to change the appearance of the Clinician ID if you do not want your ID to appear in the Device Status area. (This requires the Advanced settings access code.) However, this information is still retained in the monitor memory for recall, printing, or to send measurements electronically to the network.

# Connex CS

## Overview

A monitor can be used as standalone device or be networked to a central station (Connex CS). This section describes communication between the monitor and the central station.

Monitors communicate with the central station through hardwired Ethernet and wireless networks. The diagram below shows monitors connected to the central station.

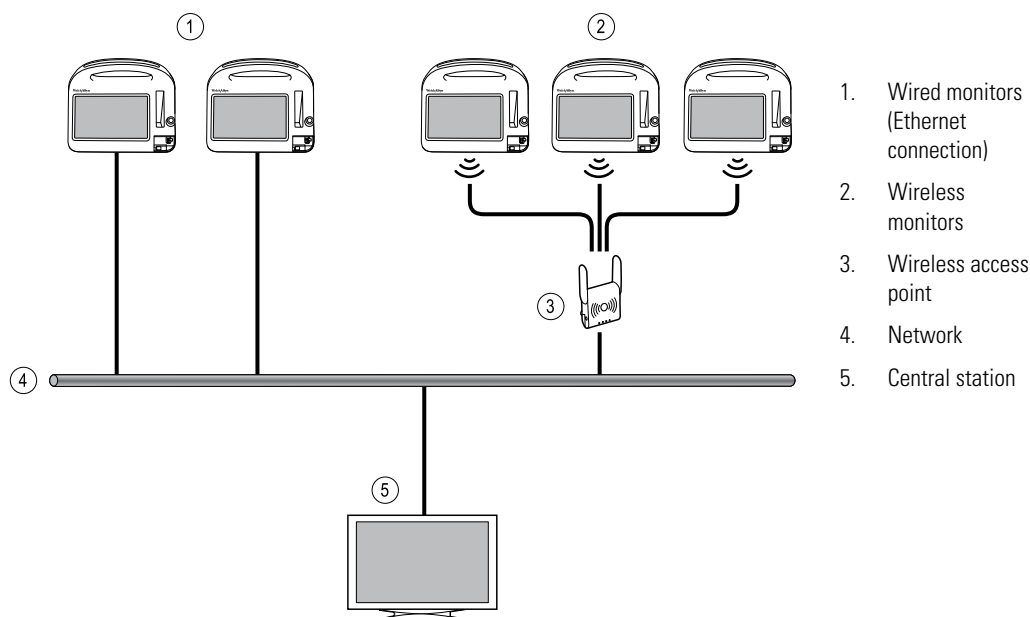

The central station provides centralized monitoring of connected monitors. This central monitoring system supports the communication of continuously monitored and intermittently acquired (episodic) data, patient vital-sign alarms, and technical equipment alerts, as well as the review and printing of all stored data.

Communication between the monitor and the central station is bi-directional but varies based on the active profile and selected advanced settings. In all profiles, for example, episodic patient data can be saved and sent to the central station, but in the Continuous Monitoring profile, patient vital-signs data streams to the central station automatically when the monitor is connected. You can enable or disable automatic connection to the

central station in Advanced settings. Furthermore, in all profiles but Triage (see Note), patients can be added to a patient list on the monitor and then sent to the central station, and patient lists also can be retrieved from a central station. In the Intervals Monitoring and Spot Check profiles, retrieving the patient list requires user action. In the Continuous Monitoring profile, the patient list on the monitor updates automatically when the monitor is connected to the central station. In all profiles, once you assign a patient to a monitor and send this information to the central station, you can only change this information at the central station—not on the monitor.

**Note** The Triage profile does not include a Patients tab and therefore does not provide a patient list.

If a monitor loses its connection to the central station, the device continues to monitor the patient, display patient data, and generate alarms and messages. When connectivity is restored, the monitor resumes sending vital-signs trends and episodic data.

## Monitor tab

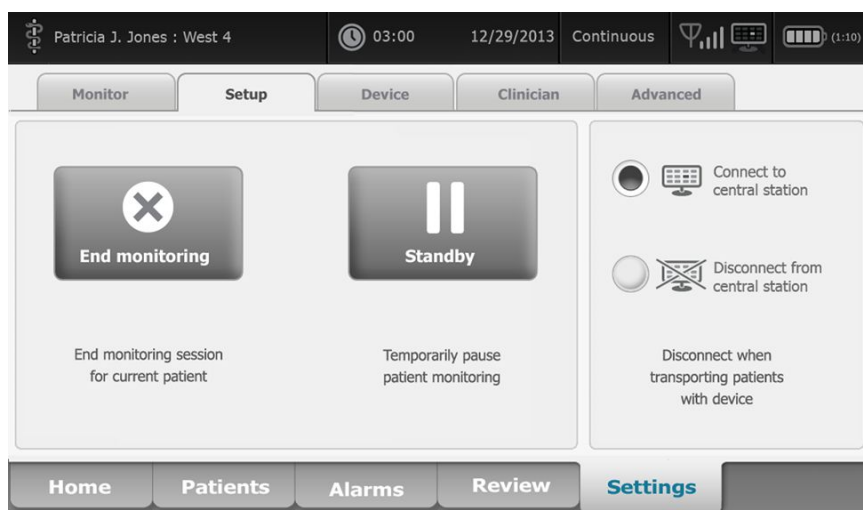

The Monitor tab provides the following controls related to continuous patient monitoring at the device and the streaming of patient vital-signs data to a central station:

- End Monitoring – Stop continuous monitoring on the current patient and clear patient data on the device.
- Standby – Pause continuous monitoring as well as alarms for a specified period and retain patient data on the device.
- Connect to central station – Manually connect to a central station and start or resume the streaming of patient vital-signs data when the device does not connect automatically.
- Disconnect from central station – Manually disconnect the device from a central station yet continue monitoring the patient and retain patient vital-signs data on the device. This control is only available after connecting to a central station.

The sections which follow provide instructions for using these controls.

**Note** This tab is visible only when the Continuous Monitoring profile is active. It is not available in the Triage, Spot Check, or Intervals Monitoring profiles.



**Note** The Continuous Monitoring profile is available only on devices with a Continuous Monitoring profile license.

## Connect to the central station

To connect the monitor to a central station over a wireless or Ethernet network connection while in the Continuous Monitoring profile, you must first enable the **Connect to CS** option in Advanced settings. When this control is enabled, the monitor automatically attempts to connect to the central station and continues to do so until a connection is achieved.

If the Continuous Monitoring profile is active but your device has been disconnected

from the central station (you will see the  indicator in the Device Status area), you can restore the connection manually.

1. Touch the **Settings** tab.  
The Monitor tab appears.
2. Select  **Connect to central station**.

As the monitor attempts to connect to the central station, a  appears in the Device Status area until a connection is achieved. When the monitor connects to the

central station, the  indicator appears.

The Connect to CS control described above only impacts the Continuous Monitoring profile, but you can configure Intervals Monitoring and Spot Check profiles to communicate with a central station as well in Advanced settings. In these configurations, if either the Intervals Monitoring or Spot Check profile is active, your device connects to the central station when you retrieve a patient list or load a patient's previously saved records with a barcode scanner. In addition, you can send episodic data to the central station when you touch Send on the Patient Review tab.

## Disconnect from the central station

Disconnecting from the central station enables you to stop streaming data to the central station yet continue monitoring your patient, retaining patient vital signs data on the monitor. Select this option when you need to transport a patient yet continue monitoring them.

1. Touch the **Settings** tab.  
The Monitor tab appears.
2. Select  **Disconnect from central station**.

If reasons for disconnecting from the central station have been configured in Connex CS, a Disconnect dialog appears with a list box of reasons.

3. Select a reason for disconnecting, if applicable, then touch **OK**.  
The Home tab appears.

## Continuous patient monitoring

Your device must be configured with the Continuous Monitoring profile to perform continuous patient monitoring.

### Key terms

Patient context	Condition in which a patient ID and patient type have been selected on a device.
Location context	Condition in which a room or a room and bed have been selected on a device.

You have the option to continuously monitor patients on the device alone (primary monitoring) or to stream continuous patient data to a central station as well (secondary monitoring).

If Continuous Monitoring has been configured as the default profile, then the device starts up in this profile. If the Continuous Monitoring profile is active, you can proceed with an existing patient and/or location context, or you can assign a patient and location.

## Activate the Continuous Monitoring profile

If the Continuous Monitoring profile is not active, follow these steps:

1. Touch the **Settings** tab.
2. Touch the **Device** tab.

The Profile vertical tab appears.

3. Select **Continuous Monitoring**.

If you have stored patient context or patient measurement data, a confirmation dialog appears with the following message: "Changing to the Continuous Monitoring profile deletes all measurement data from the device. Continue anyway?"

4. Touch **Yes** to confirm or **No** to cancel the profile change.

**Note** Selecting No enables you to send captured vitals data on the device before changing profiles. After you complete that task, if applicable, repeat steps 1–4.

5. After confirming the profile change, touch the **Home** tab.

You can now start monitoring a new patient in the Continuous Monitoring profile.

## Pause continuous monitoring (Standby mode)

You can temporarily pause continuous monitoring and retain patient data on the device when your patient needs to ambulate, use the restroom, or go off the unit for a test.

**Note** If a low-battery alarm occurs on the device, Standby mode is not available.

**Note** While in standby mode, the device retains previously stored patient data, but it does not display this data or store additional patient measurements until you exit standby mode.

1. Touch the **Settings** tab.  
The Monitor tab appears.

2. Touch **Standby**.

A "Standby" dialog appears, indicating that you have paused continuous monitoring. Controls on this screen provide options to resume or end monitoring. A countdown timer displays the time remaining before continuous monitoring resumes.

**Note** You can configure the Standby Mode timeout in Advanced settings.

## Resume continuous monitoring

You can resume continuous monitoring after a standby when patient sensors are connected to a patient. The status of the standby timer determines your next step.

### Standby time remaining

If the standby time limit has not expired (time remains on the countdown timer), resume monitoring as follows:

1. Reconnect patient sensors to the patient as needed.
2. Touch **Resume monitoring**.

The Home tab appears and continuous monitoring resumes.

### Standby time limit expired (patient sensors connected)

If the standby time limit has expired and you have already reconnected patient sensors to the patient and/or the device, the Home tab appears and continuous monitoring automatically resumes.

### Standby time limit expired (patient sensors disconnected)

If the standby time limit runs out before you have reconnected patient sensors to the patient, the monitor returns to the Home tab, and the associated alarms occur.

Reconnect patient sensors to the patient and/or device and acknowledge alarm and information messages as needed.

Continuous monitoring resumes.

## End continuous monitoring

When you no longer need to monitor a patient continuously, follow these steps to end monitoring:

1. Touch the **Settings** tab.  
The Monitor tab appears.
2. Touch **End monitoring**.

An "End monitoring" dialog appears with the following options:

- New patient – Clears patient and location context and review data after you remove patient sensors

- Power down – Clears patient and location context and review data, and powers down the device
  - Cancel – Retains patient data and returns to Home tab
3. Select the desired option.

**Note** After approximately 20 seconds of inactivity, the "End monitoring" dialog disappears. If you do not respond to this dialog and continuous monitoring is interrupted, the "Confirm patient and location" dialog appears. You must respond to this dialog before continuous monitoring resumes.

4. If you select New patient, follow the onscreen prompt to remove sensors from your patient (and the device, if applicable), and then touch **OK**.

The Home tab appears.

## Assign a patient and location

You can assign a patient and location after you have begun to monitor a patient's vital signs.

When you start to continuously monitor a patient on a device that has no patient context, the following information message appears in the Device Status area: "Assign patient and location."

1. In the top right corner of the screen, touch **Assign**.

The Patients > List tab appears.

**Note** When the monitor is connected to a central station, the monitor automatically retrieves the patient list when you navigate to the Patients tab.

2. If you see your patient's name on the patient list, select that patient entry, and then touch **Select**.

The Home tab appears with patient and/or location information filled in according to your monitor's settings.

**Note** If patient name or location information is missing, the monitor will prompt you to "Assign patient" or "Assign location" until that information is complete. You can monitor the patient without entering all of these details.

3. If your patient's name does not appear on the patient list, touch **Add**.

4. In the Patient pane, touch  in a field and enter patient information. Touch



to cycle through the patient data fields.

**Note** You can use a barcode scanner to enter a patient ID in the Patient ID field. Touch  in the Patient ID field, scan the barcode, and touch **OK**.

5. In the Location pane, select an available room and bed from the list box.

**Note** The Location list only presents locations that are not already assigned to a continuous monitoring device.

"No location assigned" appears in the list box until you select a room and bed.

6. Touch **OK** to return to the Home tab.

The information is saved.

**Note** You have the option to leave some fields blank on the Patient > Summary tab. However, if patient name or location information is missing, the monitor will prompt you to "Assign patient" or "Assign location" until that information is complete. You can monitor the patient without entering all of these details.



# Profiles

Profiles are variations of the Home tab. Each profile gives you access to a different set of features. Choose the profile that best suits your needs.

The monitor offers multiple profiles—including Continuous Monitoring, Intervals Monitoring, Spot Check, and Triage—based on the configuration and any upgrade licenses you purchase.

## Continuous Monitoring profile

The Continuous Monitoring profile is designed for continuous patient monitoring. Monitors configured with Oridion Microstream Capnography provide continuous monitoring of end-tidal CO<sub>2</sub> (etCO<sub>2</sub>), fraction of inspired CO<sub>2</sub> (FiCO<sub>2</sub>), respiration rate (RR), pulse rate, and Integrated Pulmonary Index (IPI). Monitors configured with the Nellcor pulse oximetry option provide continuous monitoring of oxygen saturation of hemoglobin (SpO<sub>2</sub>) and pulse rate. Monitors configured with the Masimo rainbow SET option may provide continuous monitoring of oxygen saturation of hemoglobin (SpO<sub>2</sub>), total hemoglobin (SpHb or SpHbv), Acoustic Respiration (RRa), and pulse rate.

The Continuous Monitoring profile also enables you to take manual temperature or NIBP readings, to use alarms and timed intervals, and to use bi-directional controls to transmit data between the monitor and a central station.

**Note** Patient data continuously streams to a central station only in the Continuous Monitoring profile.

### Oridion CO<sub>2</sub>-based Home tab



### Masimo RRa-based Home tab



## Saving vital sign measurements (Continuous Monitoring profile)

In the Continuous Monitoring profile, measurements are automatically saved as follows:

- Continuous measurements (SpO2, SpHb, pulse rate, etCO2, FiCO2, IPI, and respiration rate) are saved once per minute.
- When any measurements fall outside of alarm limits, all continuous measurements are saved.
- NIBP and predictive temperature measurements are saved when acquired.
- Manual parameters are saved when you touch the OK button on the Manual tab.
- Modifiers are set when you complete parameter setup and return to the Home tab. These modifiers do not appear on the Review tab.

After 24 hours of data has been saved for the selected patient, any data older than 24 hours is deleted from the monitor.

**Note** The monitor does not retain Direct mode temperatures in memory. Therefore, it is important to note the temperature before removing the probe from the measurement site and then manually record it in the patient record.



# Intervals Monitoring profile

The Intervals Monitoring profile enables you to use alarms and timed NIBP intervals for patient monitoring.



**Note** Patient vital signs data streams to a central station only in the Continuous Monitoring profile.

# Spot Check profile

The Spot Check profile is optimized for clinicians who take spot-check vitals readings and do not need automatic reading or alarm features.

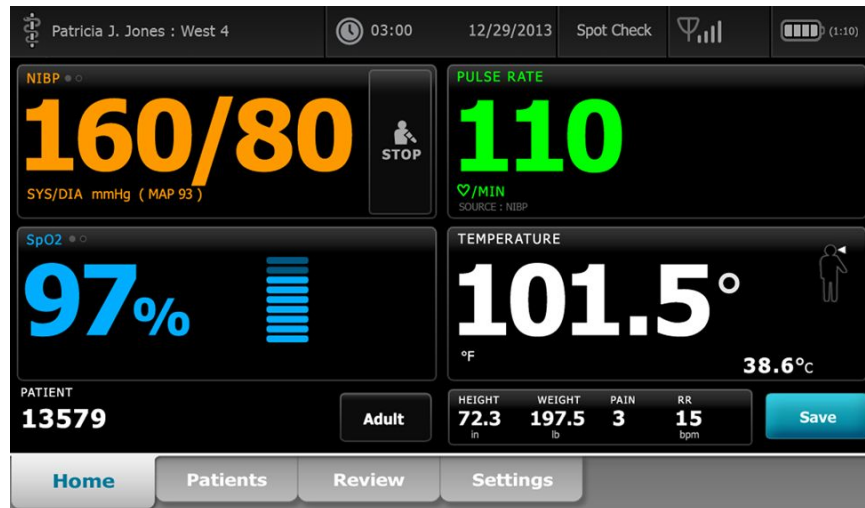

## Triage profile

The Triage profile allows for vital signs capture without alarms or access to the Patients tab.

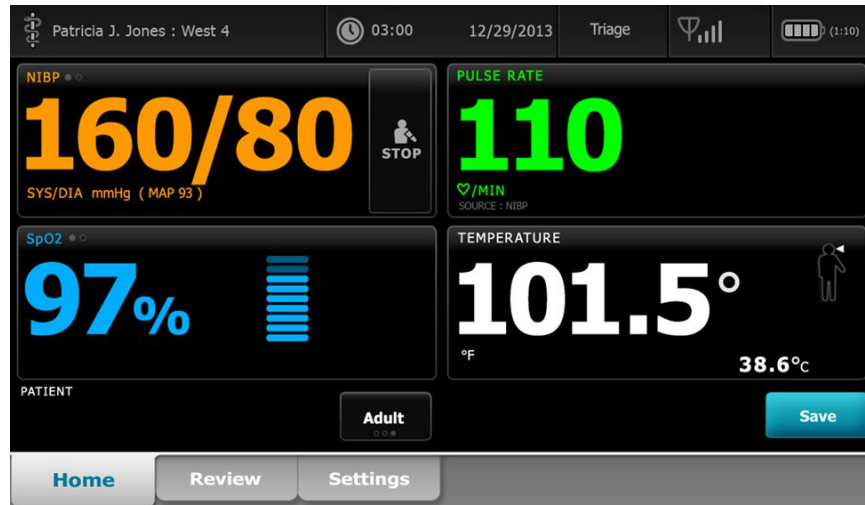

## Saving vital sign measurements (Intervals Monitoring, Spot Check, and Triage profiles)

In the Intervals Monitoring, Spot Check, and Triage profiles, you can manually save vital sign measurements to the monitor. This procedure saves measurements displayed on the Home tab, along with associated patient identification and modifiers.

After taking a patient reading, touch **Save**.

A message appears indicating a successful or failed save.

**Note** During intervals, measurements displayed on the Home tab, along with associated patient identification and modifiers, are automatically saved after each interval measurement is acquired and when some alarm conditions occur. You can manually save measurements as well.

**Note** The monitor does not retain Direct mode temperatures in memory. Therefore, it is important to note the temperature before removing the probe from the measurement site and then manually record it in the patient record.

## Profile feature comparison

The following table compares the features of the profiles.

Feature	Continuous Monitoring	Intervals Monitoring	Spot Check	Triage
Take NIBP, SpO2, temperature, and pulse rate measurements	X	X	X	X
Take SpHb measurements (Masimo only)	X	X		
Monitor etCO2, FiCO2, IPI, and RR (Oridion only)	X			
Monitor RRa (Masimo only)	X			
Configure and use interval timing setting	X	X		
Observe and configure alarm limits	X	X		
Observe and respond to physiological alarms	X	X		
Change patient type (adult, pediatric, neonate)	X	X	X	X
View and enter manual parameters (height, weight, pain, respiration, temperature*, BMI**)	X	X	X	
Save currently displayed vital signs data to device memory	X	X	X	X
Review saved vital signs data	X	X	X	X
Use bi-directional controls between monitor and external systems	X	X	X	X

\* Braun IR thermometers configured to work with the monitor transfer temperature data automatically to the Temperature frame. You can enter temperature manually if you take a patient temperature with a thermometer that is not connected to the monitor, and you have selected temperature as one of the four manual parameters to display.

\*\* Body Mass Index (BMI) is calculated and transferred to the monitor only by an attached weight scale. You cannot enter or adjust BMI values. BMI displays on the Manual tab and in the Manual parameters frame if you have selected it as one of the four parameters to display.

## Select a profile

Follow these steps to select a profile, which controls the appearance and functionality of the device.

1. Touch the selected profile indicator in the Device Status area.

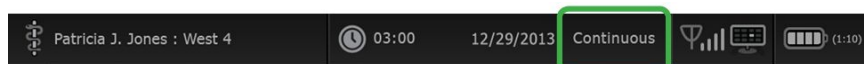

The Profile vertical tab appears.

**Note** When the device is in the Continuous Monitoring profile, and episodic or continuous trend data has been stored on the device, the profile control is disabled.

**Note** You cannot change profiles while acquiring patient measurements or while unsaved patient measurements are on the device.

2. To change from the Continuous Monitoring profile to any other profile, complete the following steps:

- a. Touch **End monitoring**.

An "End monitoring" dialog appears with the following options:

- New patient – Clears patient and location context and review data after you remove patient sensors
- Power down – Clears patient and location context and review data, and powers down the device
- Cancel – Retains patient data and returns to Home tab

**Note** Ending monitoring removes unsaved patient measurement data from the device.

- b. Select the desired option and touch **OK**.

The Profile tab appears to confirm your profile selection.

- c. Touch **Home** to return to the Home tab.

3. To change from any profile to the Continuous Monitoring profile, complete the following steps:

- a. Select the desired option.

A confirmation dialog appears.

**Note** Changing profiles removes unsaved patient measurement data from the device.

- b. Touch **Yes** to continue or **No** to stop the process and return to the Profile vertical tab.

If you select Yes, a "Confirm patient and location" dialog appears with the following options:

- New patient – Clears patient and location context and review data after you remove patient sensors
- Power down – Clears patient and location context and review data, and powers down the device
- Cancel – Retains patient data and returns to Home tab

- c. Select the desired option and touch **OK**.

The Home tab appears.

# Patient data management

---

Patient demographic data is managed on the Patients tab.

From this tab, you can do the following:

- Retrieve a patient list from the network (for example, electronic medical records (EMR) or a central station).
- Select a patient from the list.
- Manually create patient entries and a patient list.
- Scan a patient ID with the barcode scanner and return a patient name match from your host system.

**Note** The patient name match could come from EMR or a central station.

- Enter additional patient information such as manual parameters.
- Assign a patient and location to device only or to a central station during continuous monitoring.





**CAUTION** Verify patient identity on the monitor after manual or barcode entry and before printing or transferring patient records.

## Add a patient to the patient list

**Note** If the monitor is configured to retrieve the patient list from the network and is in the Spot Check or Intervals Monitoring profile, you cannot manually add a patient to the patient list.

**Note** If the monitor is configured to retrieve the patient list from the central station and is in the Continuous Monitoring profile, you can add a patient to the patient list and transfer it to the central station.

1. Touch the **Patients** tab.
2. Touch **Add**.

3. Touch  and then enter patient information. Touch  to cycle through the patient data fields.

**Note** You can use a barcode scanner to enter a patient ID in the Patient ID field. Touch  in the Patient ID field, scan the barcode, and touch **OK**.

4. Touch **OK** to return to the Home tab.

The information is saved.



**CAUTION** Verify patient identity on the monitor after manual or barcode entry and before printing or transferring patient records.

## Load patient data with the barcode scanner

You can use a barcode scanner to query existing patient records and perform a patient name match with the host system.

**Note** If the monitor is connected to the network, the monitor can receive a patient name from patient records associated with a scanned ID number.

1. Ensure that you are on the Home tab.
2. Scan the patient's barcode with the barcode scanner.

The Patient ID appears in the Patient frame.



**CAUTION** Verify patient identity on the monitor after manual or barcode entry and before printing or transferring patient records.

## Select a patient

1. Touch the **Patients** tab.
2. If the monitor is connected to the network, touch **Retrieve list** on the List tab.

The monitor retrieves the patient list from the network.

**Note** When the monitor is connected to a central station, the monitor automatically retrieves the patient list when you navigate to the Patients tab.

3. From the patient list, touch the patient's identifier (name, ID number, or location).  
The patient's identifier is determined in Advanced settings.
4. Touch **Select**.

**Note** In the Spot Check and Triage profiles, previous patient data will be overwritten by a new save. In the Intervals and Continuous profiles, selecting a new patient will clear the current patient data and measurements.

Patient data can be sorted in ascending or descending order by selecting the heading row and touching ▲ or ▼.

## Manage patient records (Continuous Monitoring profile)

In the Continuous Monitoring profile, the Review tab enables access to a trend table of all readings for the currently selected patient. You can configure the time intervals displayed, and you can scroll through the last 24 hours of patient measurements. Trend data can be printed from this tab.

1. Touch the **Review** tab.



**Note** Measurements that triggered a physiological alarm are highlighted on this tab.

Barker, David	14:00	15:00	15:04	16:00	17:00	18:00	18:51	19:00
IPI	9	10	9	9	9	9	9	10
RR bpm	15	19	15	15	19	15	19	18
SpO2 %	97	98	97	97	99	97	85	100
etCO2 mmHg	46	45	46	46	45	46	45	40
Pulse rate /MIN	70	68	200	70	64	70	64	71
NIBP SYS/DIA kPa	122/73		122/73	122/73		122/73	124/82	121/73

2. Modify the trend interval (the progression of time displayed horizontally in the table) by using the View drop-down menu. Trend interval options are 1, 5, 15, 30, and 60 minutes; 2, 4, or 8 hours; and alarms only. The default trend interval is 1 minute.

**Note** By modifying the trend interval, you can view additional "events" (e.g., physiological alarms, manual NIBP or temperature measurements, Manual parameter entries) between the currently configured time intervals.

3. Use the scroll bar on the right to view patient measurements for any parameters that do not fit in the display area.

4. Touch the page forward  and page backward  controls in the table header to view additional measurements for this patient. The most recent measurements appear on the right of the table, with older measurements to the left.

5. Touch **Print** to print the patient's record.

A Print options dialog appears.

6. Select the desired Timespan and touch **Print**.

**Note** If no patient is selected and continuous monitoring is not active, all table cells in the Review tab remain blank.

**Note** In the Continuous Monitoring profile, you cannot delete saved patient measurements. Patient measurements older than 24 hours are automatically deleted from the Review tab.

**Note** The date and time stamps on saved patient measurements will adjust in response to new date and time settings.

**Note** In the Continuous Monitoring profile, the Send option is not available on the Review tab.

## Manage patient records (Intervals Monitoring, Spot Check, and Triage profiles)

Patient records can be sent to the network, printed, or deleted in these profiles.

**Note** Because the Patient tab is not available in the Triage profile, records saved in the Triage profile contain only vital signs measurements. Even without patient identification, these records can be sent to the network, printed, or deleted.

1. Touch the **Review** tab.

**Note** Measurements that triggered a physiological alarm are highlighted on this tab.

Patient name	Date / Time	NIBP	Temp	PR	SpO2	SpHb	Ht	Wt	P	RR
Barker, David A	12/29/2011 11:22	145/100 (101)	100.8	90	99	11.8	54.1	123.5	4/38	
<input checked="" type="checkbox"/> Smith, David A	<input type="checkbox"/> 12/29/2011 10:00	132/98 (96)	101.1	101	98	12.1	61.2	213.5	5/28	
<input type="checkbox"/> 204 A	<input type="checkbox"/> 12/29/2011 9:31	135/99 (100)	99.8	98	98	13.6	48.7	196.9	1/22	
<input type="checkbox"/> 8704330177	<input type="checkbox"/> 12/29/2011 8:44	120/80 (96)	101.1	97	97	14.9	68.5	271.4	1/28	
<input type="checkbox"/> Carter, Grace C	12/29/2011 7:55	145/100 (101)	101.1	98	99	15.1	74.1	200	3/23	
<input type="checkbox"/> Murphy, Michael	<input type="checkbox"/> 12/29/2011 6:58	132/98 (96)	99.8	97	97	16.8	72.4	188.2	8/40	

2. Select patients by touching the check box next to their names.
3. Touch **Send** to transmit the records to the network, **Print** to print the records, or **Delete** to permanently remove the records as desired.



**CAUTION** Verify patient identity on the monitor after manual or barcode entry and before printing or transferring patient records.



**CAUTION** Always visually verify the printed patient records.

**Note** The  icon indicates the records have been sent to the network.

**Note** You can configure some profiles and settings to automatically send measurements to the network.



**Note** Patient measurements older than 24 hours are automatically deleted from the Review tab.

**Note** The date and time stamps on saved patient measurements adjust in response to new date and time settings.

## Printer

The monitor prints to a strip to create printouts of patient information and data.

**Note** The sample printouts below are English, but the language in the printouts is defined by the language selected on the monitor.

Patient:				
ID: 13579				
Room/Bed:				
Clinician:				
SYS/DIA (MAP) PR	SpO2	Temp		
(mmHg)	(BPM)	(%)	(°F)	
-----				
12/31/2011 @ 07:46				
	78	97		
12/31/2011 @ 07:46				
86/55 (65)	78	97		
12/31/2011 @ 07:46				
110/71 (84)	82	97		
12/31/2011 @ 07:46				
102/63 (76)	78	97		
12/31/2011 @ 07:46				
105/67 (79)	80	96		
12/31/2011 @ 07:46				
100/64 (76)	77	97		

Intervals Monitoring report

Patient:		
ID: 13579		
Room/Bed:		
Clinician:		
12/31/2011 @ 08:53		
SYS	106	mmHg
DIA	68	mmHg
MAP	81	mmHg
PR	71	BPM
SpO2	??	
Temp	97.8	°F
Height	177.8	cm
Weight	68.0	kg
Pain	0	
RR	12	bpm

Spot Check report

Patient:	Page 1	09/11/2012	23:57	23:58	23:59	00:00	00:01	00:02	*
ID: 13579									*
Type: Adult	NIBP	mmHg	111/69(83)	120/80(90)					*
Room/Bed: 256 B	SpO2	%	93	100	94	95	96	99	*
Clinician: 987-65-4321	SpHb	g/dL	10.7	7.4	7.0	7.2	9.3	13.1	*
	PR	/MIN	58	60	56	71	60	56	*
	etCO2/FiCO2	mmHg	11(1)	33(0)	35(0)	34(0)	37(0)	38(0)	*
Vital Signs Table	IPI		9	9	10	9	9	8	*
09/12/2012 00:02	RR	/MIN	19	13	13	14	15	14	*
View: 1 min	Temp	°F		98.5					*
Timespan: 5 min	Weight	lb	168						*
	Pain		4	10			3		*

Continuous Monitoring trend data report

## Delete a patient from the list

1. Touch the **Patients** tab.
2. From the List tab, touch the patient record you want to delete.
3. Touch **Delete**.

At the Delete Confirmation window, touch **OK** to permanently delete the selected patient. Touch **Cancel** to cancel the deletion.

**Note** Deleting a patient from the Patients List does not delete saved records. Touch the **Review** tab to see or delete saved records.

**Note**

For monitors connected to the network, deleting a patient on the monitor does not affect data on the network.

# Alarms

---

The monitor presents physiological alarms and technical alarms. Physiological alarms occur when vital sign measurements fall outside of set alarm limits, but they occur only in the Continuous Monitoring and Intervals Monitoring profiles. Technical alarms occur when there is a problem with the monitor, an accessory connected to the monitor, or the network. Technical alarms occur in all profiles.

The monitor can communicate alarms to the following external systems:

- Nurse Call systems
- Welch Allyn software systems (Connex CS and Connex VM)



**WARNING** The monitor is the primary alarming source for the patient, and any external system (such as a Nurse Call or Connex CS) is a backup alarm source. The external system is only as reliable as its network and can be relied on only as a backup alarming device.



**WARNING** When the monitor is not connected to a secondary alarm system during continuous patient monitoring, check the monitor regularly to receive patient data, alarms, and alerts.

**Note** USB is not intended for remote communication of continuous parameters and continuous alarms. Ethernet and wireless are intended for communication of vital signs parameters, patient data, and alarms (including continuous and episodic parameters and alarms) to secondary remote viewing and alarming systems.

## Alarm types

Type	Priority	Color	Alarm audio tone
<ul style="list-style-type: none"> <li>• NIBP, SpO<sub>2</sub>, SpHb, etCO<sub>2</sub>, respiration, pulse rate, or IPI limit exceeded</li> <li>• No breath detected</li> <li>• Some technical alarms</li> </ul>	High	Red	10-pulse tone
<ul style="list-style-type: none"> <li>• Temperature or FiCO<sub>2</sub> limit exceeded</li> <li>• Some technical alarms</li> </ul>	Medium	Amber	3-pulse tone
<ul style="list-style-type: none"> <li>• Some technical alarms</li> </ul>	Low	Amber	2-pulse tone or 1-pulse tone at 30-second intervals

Type	Priority	Color	Alarm audio tone
<ul style="list-style-type: none"> <li>Technical alarms that don't impact patient safety</li> <li>Some calibration information messages</li> </ul>	Very low	Cyan	2-pulse tone or 1-pulse tone at 5-minute intervals

## Alarm notification locations on the monitor



**WARNING** Whenever possible, do not rely on visual alarm notifications alone while monitoring patients. If you must rely on visual alarm notifications, maintain a clear line of sight with the monitor. For audio alarm notifications, set the volume as needed considering the environment and ambient noise levels. Verify that the alarm is audible to a clinician working at the maximum distance from the monitor.

### LED light bar

The light bar on the handle of the monitor illuminates as follows:

- Flashing red for high-priority alarms
- Flashing amber for medium-priority alarms
- Constant amber for low-priority and very low-priority alarms

The light bar darkens when the alarm tone is reset.

### Home tab

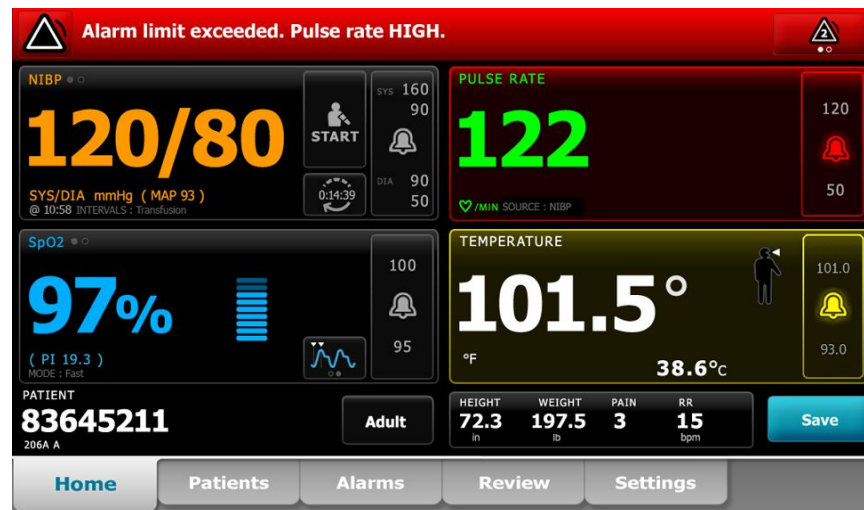

### Home tab notifications

Notification	Description
Device Status area	<p>The area changes color and displays a message with an accompanying status icon or button. If the alarm tone is in a pause interval, a timer countdown appears.</p> <p>If multiple alarms are active, the device provides options to manually toggle or autoscroll through the alarms. You can cycle through each alarm message in sequence of priority by touching the multiple alarm toggle. Alternatively, the autoscroll option displays each alarm message in sequence of priority for approximately 4 seconds, and then loops back</p>

---

## Home tab notifications

---

Notification	Description
	<p>to the top priority message. In either option, when multiple alarm messages of the same priority exist at the same time, the device displays the most recent of those alarm messages first.</p> <p>Information messages instruct you to interact with the monitor in a specific way or provide information that does not require action. You can dismiss an information message by selecting the control associated with the message or waiting for the message to time out.</p>
Parameter frame	<p>The background color changes. Touch this area to reset (pause or turn off) the alarm tone.</p> <p> <b>WARNING</b> Do not pause or turn off an audible alarm if patient safety might be compromised.</p> <p>After the tone is reset, visual indicators remain until the condition is corrected, the next measurement is taken, or the alarm is cancelled.</p>
Alarm Limit control	<p>The control appears in each parameter frame.</p> <p>The icon in this control indicates the status of the alarm limit settings. Red and amber icons indicate measurements that have exceeded alarm limits.</p> <p>Touch this control to navigate to a parameter-specific tab where you can modify alarm limit settings. The control also displays alarm limits in some device configurations.</p>

---

## Icons on the Home tab



### Icons in parameter frames

The icons in the parameter frames indicate alarm notification settings. When alarm limits are on, the icons are black and white until an alarm occurs. Then, the icons change color to indicate the priority of the alarm. Red icons represent high-priority alarms, and amber icons represent medium- or low-priority alarms.

---

### Icons in parameter frames

---

Icon	Name and status
	<p>Alarm off.</p> <p>No visual or audio alarms occur for this parameter.</p> <p>You are fully responsible for maintaining awareness of the patient's condition.</p>
	<p>Alarm on.</p> <p>Audio and visual notifications are enabled.</p>
	<p>Alarm audio off.</p> <p>Only visual notifications occur.</p> <p>If the patient is being monitored continuously, maintain a clear line of sight with the monitor while audio alarms are disabled.</p>

---

---

**Icons in parameter frames**

---

**Icon****Name and status**

Alarm audio paused.

The audio tone is paused. The icon remains until the paused time counts down to 0.

---

**Icons in the Device Status area**

The icons in the Device Status area are black and white, but the background area changes colors to indicate the alarm priority. Messages accompany these icons. These icons can be controls or status indicators.

---

**Icons in the Device Status area**
**Icon****Name and status**

Alarm active.

One or more alarms are active. Touch this icon to reset (pause or turn off) the alarm tone.



**WARNING** Do not pause or turn off an audible alarm if patient safety might be compromised.

---



Alarm audio off.

Audio signals are disabled, but alarm limits and visual alarm signals remain active.

If the patient is being monitored continuously, maintain a clear line of sight with the monitor while audio alarms are disabled.

---



Multiple alarms toggle.

Touch this icon to cycle through the messages for each active alarm.

---



Alarm audio paused.

The audio tone is paused. The icon remains until the paused time counts down to 0. Touch this icon to start the user-configured pause interval (set in the Advanced tab).

---

## Reset (pause or turn off) audio alarms







**WARNING** Do not pause or turn off an audible alarm if patient safety might be compromised.

**Audio alarm characteristics**

- After you reset an audio alarm, some tones do not return, but others return after a pause interval if the condition that caused the alarm persists.
- If a new alarm condition occurs during a pause interval, a new audio tone occurs.
- If an audio alarm is not paused or turned off after a period of time, a buzzer accompanies the tone.

**Pause or turn off an audio alarm**

1. In the Device Status area, touch .
  - Visual indications remain in the parameter frame until the condition is corrected, the next measurement is taken, or the alarm is cancelled.
  - In the Device Status area, if the icon changes to  and the message remains, the timer counts down a fixed pause interval of 60 seconds. The alarm tone returns after the pause interval. A longer pause interval can be configured in the Advanced tab. You start the configured pause interval by touching .
 

If you responded to an NIBP alarm and multiple NIBP limits have been exceeded, the alarm tone pauses, the first message clears, and the next NIBP limit message appears with a countdown timer. A new NIBP alarm tone sounds after the countdown unless you touch  to dismiss each remaining NIBP limit message.
2. If multiple alarms are active, a multiple alarm toggle appears in the Device Status area. The monitor will either autoscroll through the alarm messages, displaying each for approximately 4 seconds in order of priority, or you can move through the alarms manually. Respond to multiple alarms manually as follows:

- a. Touch  to pause all audio alarms.

The alarm icon changes to  and the timer counts down a fixed pause interval of 60 seconds. The alarm tone returns after the pause interval.

- b. Touch  in the Device Status area to view each alarm in the stack.

**Note** The multiple alarm toggle button displays the number of active alarms inside the alarm icon. A set of dots indicating the display order of alarms from highest (left) to lowest (right) priority (as well as the most recent in the case of multiple alarms of the same priority) appears below it.

## Cancel a paused alarm

You can clear a paused alarm from the Home tab. If the condition that caused the alarm persists, a new alarm appears with visual and audio notification.

1. On the Home tab, touch the alarm limits control in the selected parameter frame.  
The Alarms tab for that parameter appears.



2. Touch .

The alarm clears.



3. Touch .

4. Touch the Home tab and confirm that  appears in the parameter frame.

## Adjust vital sign alarm limits

You can adjust vital sign alarm limits or turn off alarm limit checking for individual parameters.



**WARNING** Alarm limits are patient-specific. For alarms to function properly, you must set or verify alarm limits appropriate for each patient. Each time the monitor is powered on, you must check that the alarm settings are appropriate for your patient before you start monitoring.



**CAUTION** Loss of power will cause the monitor to return to default settings. Each time you power up the monitor, you must set alarm limits appropriate for your patient.

1. On the Home tab, touch the alarm limits control in the selected parameter frame. For





example, to adjust the NIBP alarm limits, touch

2. Adjust vital sign alarm limits.

- To adjust a limit: Enter the desired upper and lower alarm limits using the up/down arrow keys or the keypad.



- To turn alarm limits off or on for the vital sign: Touch  or . This button toggles to display the current alarm state. If you turn off alarm limit checking for a vital sign, no visual or audio alarm signals will occur for those limits. If alarm limit checking is off, the icon changes to



on the Home tab in the parameter frame.



# Modify audio alarm notification

You can modify the volume of all audio alarms.

**Note** If the *Allow user to turn off general audio* option is selected in Advanced settings, you can turn off audio alarms. Whenever possible, however, do not rely on visual alarm notifications alone while monitoring patients. If the patient is being monitored continuously, maintain a clear line of sight with the monitor while audio alarms are disabled.



**WARNING** If you are relying on audio alarm notifications, set the volume as needed considering the environment and ambient noise levels. Verify that the alarm is audible to a clinician working at the maximum distance from the monitor.

As you are working in the Alarms tab, parameter measurements appear across the top of the tab.

1. Touch the **Alarms** tab.

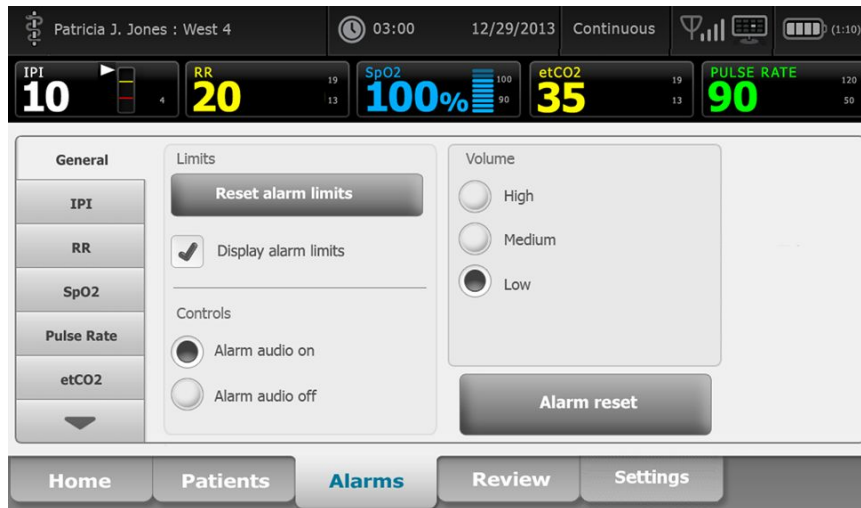

2. On the **General** tab, modify audio alarm notification.
  - To enable or disable audio alarms, select **Alarm audio on** or **Alarm audio off**. If you turn off audio alarms, visual alarm signals still occur in the LED light bar, Device Status area, and on the Home tab in parameter frames.



The  in the Device Status area indicates alarm audio turned off, and a



similar bell appears in the parameter frames . If an alarm condition occurs, the bell is red or amber in the alarming frame, according to the priority of the

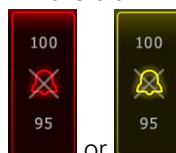

alarm, as shown here:  or .

- To modify the volume of audio alarms: Select a volume level. An audio tone sounds briefly to indicate the volume level.

## Alarm messages and priorities

The following tables list the physiological and technical alarm messages and their priority.

### Physiological alarms

<b>Alarm messages</b>	<b>Priority</b>
Alarm limit exceeded. etCO2 HIGH.	High
Alarm limit exceeded. etCO2 LOW.	High
Alarm limit exceeded. FiCO2 HIGH.	Medium
Alarm limit exceeded. IPI LOW.	High
No breath detected. Exceeded time limit since last breath.	High
No breath detected.	High
Alarm limit exceeded. Respiration HIGH.	High
Alarm limit exceeded. Respiration LOW.	High
Alarm limit exceeded. NIBP systolic HIGH.	High
Alarm limit exceeded. NIBP systolic LOW.	High
Alarm limit exceeded. NIBP diastolic HIGH.	High
Alarm limit exceeded. NIBP diastolic LOW.	High
Alarm limit exceeded. NIBP MAP HIGH.	High
Alarm limit exceeded. NIBP MAP LOW.	High
Alarm limit exceeded. SpO2 HIGH.	High
Alarm limit exceeded. SpO2 LOW.	High
Alarm limit exceeded. SpHb HIGH.	High
Alarm limit exceeded. SpHb LOW.	High
Alarm limit exceeded. Pulse rate HIGH.	High
Alarm limit exceeded. Pulse rate LOW.	High
Alarm limit exceeded. Temperature HIGH.	Medium
Alarm limit exceeded. Temperature LOW.	Medium

## Technical alarms

<b>Alarm messages</b>	<b>Priority</b>
Low battery 5 minutes or less remaining.	High
Searching for pulse signal.	High
Communications module did not power on properly. Power down the device.	High
Occlusion in gas line.	High
Network not found; check network cable connection.	Very low
Battery is absent or faulty.	Very low
Battery is absent or faulty. Call for service.	Very low
NIBP air leak; check cuff and tubing connections.	Very low
NIBP not functional. Call for service.	Very low
Unable to determine NIBP; check connections and tubing for kinks.	Very low
Incorrect NIBP cuff size; check patient type.	Very low
Inflation too quick; check NIBP cuff and tubing connections.	Very low
Unable to determine NIBP; check connections; limit patient movement.	Very low
Unable to determine NIBP; check inflation settings.	Very low
SpO2 not functional. Call for service.	Very low
Attach SpO2 sensor to monitor.	Very low
Replace the SpO2 sensor.	Very low
Set date and time.	Very low
Maximum number of patient records saved. Oldest record overwritten.	Very low
Connect temperature probe.	Very low
Insert correct color-coded probe well.	Very low
Replace temperature probe.	Very low
Temperature not functional. Call for service.	Very low
Retry temperature measurement.	Very low
Temperature time limit exceeded. Retry temperature measurement.	Very low
Low battery, unable to print; plug into outlet.	Very low

<b>Alarm messages</b>	<b>Priority</b>
Printer door is open; close to continue.	Very low
Printer not functional. Call for service.	Very low
Out of paper.	Very low
Printer too hot; wait to retry.	Very low
Radio not functional. Call for service.	Very low
Radio error. Power down and restart.	Very low
Radio error. The radio has restarted.	Very low
Unable to establish network communications. Radio out of network range.	Very low
Unable to establish network communications. Call for service.	Very low
Radio software upgrade failed.	Very low
Unable to load configuration; using factory defaults.	Very low
Functional error. Call for service.	Very low
External device not recognized.	Very low
Incompatible Welch Allyn device.	Very low
USB Communication failure. Call for service.	Very low
Low battery 30 minutes or less remaining.	Very low
Low SpHb signal quality. Check sensor.	Very low
Low SpO2 signal quality. Check sensor.	Very low
Low perfusion. Check sensor.	Very low
Replace the SpO2 cable.	Very low
SpO2 mode only. Check sensor or cable.	Very low
SpO2 sensor expires in...	Very low
Unexpected restart occurred. Call for service.	Very low
Weight scale not functional. Call for service.	Very low
CO2 not functional. Call for service.	Very low
Filter line disconnected.	Very low
CO2 module temperature is out of range. CO2 might not be accurate.	Very low

<b>Alarm messages</b>	<b>Priority</b>
CO2 is not calibrated.	Very low
Check exhaust port for occlusion.	Very low
Check for occlusion in gas line.	Very low
Connect or clear filter line.	Very low
Purging filter line.	Very low
Check calibration gas concentration.	Very low
Check calibration gas flow.	Very low
Calibration is overdue. CO2 might not be accurate.	Very low
Factory service is overdue. CO2 might not be accurate.	Very low
Calibration failed.	Very low
Calibration completed successfully.	Very low
Calibration aborted.	Very low
RRa low signal strength.	Very low
RRa write config error.	Very low
RRa respiratory pause.	Very low
No new RRa calculation.	Very low
CO2 auto-zero in progress.	Very low
Respiratory freshness timeout expired.	Very low
Replace RRa sensor.	Very low
Background interference detected.	Very low
Patient interference detected.	Very low
File system formatted on first-time startup.	Very low
Lost connectivity with host.	Low

## Nurse call

The monitor can be connected to a Nurse Call system through a cable that connects to the Nurse Call connector.

When the Nurse Call cable is connected and Nurse Call is enabled, the monitor notifies the Nurse Call system when an alarm that exceeds the preset threshold occurs. Nurse Call notification persists until one of the following occurs on the monitor:

- The alarm clears.
- You reset (pause or turn off) the alarm tone.

For paused alarms, Nurse Call notification returns after the pause interval if the condition that caused the alarm persists.

Nurse Call thresholds are set in the *Advanced Settings*.

To connect the monitor to a Nurse Call system, you must have a cable that has been adapted to your Nurse Call system (REF 6000-NC), rated 25V AC or 60V DC maximum at 1A maximum. For ordering information, see *Approved Accessories* on the CD.



**WARNING** The monitor is the primary alarming source for the patient, and any external system (such as a Nurse Call or software system) is a backup alarm source. The external system is only as reliable as its components (e.g., wiring, hardware, light bulbs, connections) and can be relied on only as a backup alarming device.

# Patient monitoring

---



**WARNING** When the monitor is not connected to a secondary alarm system during continuous monitoring, check the monitor regularly to receive patient data, alarms, and alerts.

## Capnography (CO<sub>2</sub>)

Monitors configured with Oridion Microstream® capnography continuously measure or indicate the following:

- End-tidal CO<sub>2</sub> (etCO<sub>2</sub>): the level of CO<sub>2</sub> in a patient's exhaled breath
- Fraction of inspired CO<sub>2</sub> (FiCO<sub>2</sub>): the level of CO<sub>2</sub> in a patient's inhaled breath
- Respiration rate (RR)
- Integrated Pulmonary Index (IPI): a numerical value that integrates four parameters (CO<sub>2</sub>, respiration rate, SpO<sub>2</sub>, and pulse rate) and indicates a patient's overall respiratory status

**Note** Monitors configured with Oridion Microstream capnography cannot be configured with Acoustic Respiration (RRa).

## etCO<sub>2</sub> frame

The etCO<sub>2</sub> frame displays data and controls used in monitoring the level of CO<sub>2</sub> in a patient's breath (etCO<sub>2</sub> and FiCO<sub>2</sub>). Controls to pause or restart the CO<sub>2</sub> pump as well as to pause CO<sub>2</sub> alarms also appear in the frame.

**Note** CO<sub>2</sub> monitoring is available only with the Continuous Monitoring profile.

The frame provides a numeric view and a waveform view of CO<sub>2</sub> data. You can toggle between views by touching the left side of the frame.

### etCO<sub>2</sub> numeric view

The numeric view displays end-tidal CO<sub>2</sub> (etCO<sub>2</sub>) and fraction of inspired CO<sub>2</sub> (FiCO<sub>2</sub>) in mmHg or kPa. The size of the etCO<sub>2</sub> frame and displayed measurements varies based on your configuration.



## CO2 waveform view

The CO2 capnogram waveform view displays the CO2 waveform, enabling you to observe a patient's breathing patterns and to determine adequate, hyperventilation, or hypoventilation conditions.

The size of the etCO2 frame and displayed measurements varies based on your configuration.



## Set up etCO2

Follow these steps to configure etCO2 parameter options.

1. Touch the **Settings** tab.
2. Touch the **Setup** tab.
3. Touch the **etCO2** vertical tab.
4. Adjust the following settings as desired:
  - Sweep speed. Select the desired speed. You can set the default in Advanced settings.
  - Waveform scale. Select the scale using the toggle button. You can set the default in Advanced settings.
  - Pump standby time. Select the time using the toggle button.
5. Touch the **Home** tab.

The new settings take effect immediately.

## Configure etCO2 and FiCO2 alarms

Follow these steps to set alarm limits for CO2 measurements.

**Note** FiCO2 appears only if selected in Advanced settings.

1. Verify that you are using the Continuous Monitoring profile.
2. Touch the **Alarms** tab.
3. Touch the **etCO2** vertical tab.
4. Ensure that the etCO2 and FiCO2 alarm limit controls are set to ON.

**Note** If any parameter's alarm limit control is set to OFF, you cannot adjust alarm limits on the Alarm tab, and no visual or audio signals occur for that specific parameter.



5. Adjust the following settings as desired:
  - etCO<sub>2</sub> limits. Enter upper and lower alarm limits for etCO<sub>2</sub> using the up/down arrow keys or the keypad next to the Limits control.
  - FiCO<sub>2</sub>. Enter the desired upper alarm limit for FiCO<sub>2</sub>, if activated, using the up/down arrow keys or the keypad next to the FiCO<sub>2</sub> control.
  - High alarm delay. Select the duration using the list box. This alarm delay specifies the minimum duration of a high alarm limit condition to activate an alarm signal. You can set the default in Advanced settings.
6. Touch the **Home** tab.  
The new alarm settings take effect immediately.

## Measure CO<sub>2</sub>

Before you begin, read the Microstream CO<sub>2</sub> sampling line's directions for use.



**WARNING** Loose or damaged connections can compromise ventilation or cause an inaccurate measurement of respiratory gases. Securely connect all components and check connections for leaks according to standard clinical procedures.



**WARNING** When using a sampling line for intubated patients with a closed suction system, do not place the airway adapter between the suction catheter and endotracheal tube. This is to ensure that the airway adapter does not interfere with the functioning of the suction catheter.



**WARNING** Do not cut or remove any part of the sampling line. Cutting the sampling line could lead to erroneous readings.



**WARNING** Inaccurate measurement or equipment malfunction risk. If too much moisture enters the sampling line (e.g., from ambient humidity or breathing unusually humid air), the message "Purging filter line" will appear in the Device Status area. If the sampling line cannot be cleared, the message "Occlusion in gas line" will appear. Replace the sampling line when this message appears.



**WARNING** The sampling line might ignite in the presence of O<sub>2</sub> when directly exposed to lasers or high heat. When performing head and neck procedures involving lasers or high heat, use with caution to prevent combustion of the sampling line or surrounding surgical drapes.



**CAUTION** Only use Welch Allyn-approved CO<sub>2</sub> sampling lines to ensure the monitor functions properly.



**CAUTION** Microstream CO<sub>2</sub> sampling lines are designed for single patient use and are not to be reprocessed. To prevent damage to the monitor, do not attempt to clean, disinfect, or blow out the sampling line.



**CAUTION** Dispose of Microstream CO<sub>2</sub> sampling lines according to standard operating procedures or local regulations.

1. Verify that you are using the Continuous Monitoring profile.
2. Touch the patient type control on the right side of the Patient frame.  
The Patient Summary tab appears.
3. Select the patient type, then touch **OK**.

4. Select the appropriate sampling line based on the following considerations:
  - Whether the patient is intubated or non-intubated
  - Whether the patient is on mechanical ventilation
  - Duration of use
  - Patient's size and weight
5. Connect the sampling line to the monitor.
  - a. Slide open the door that protects the sampling line port on the monitor.
  - b. Connect the sampling line.

**Note** The CO<sub>2</sub> pump starts as soon as the pump sensor recognizes the sampling line. This can occur before you completely connect the sampling line.

- c. Turn the connector completely to the right until tight.

An etCO<sub>2</sub> sampling line dialog appears on the screen to reinforce this instruction (unless the dialog is disabled in Advanced settings).



**WARNING** You must connect the sampling line correctly. Ensure that the connector is tight to accurately monitor CO<sub>2</sub>.

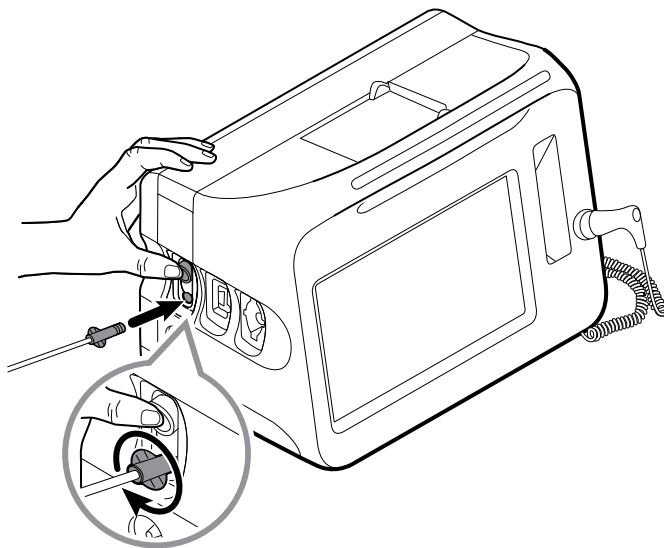

**Note** This secure connection prevents gases from leaking at the connection point during measurement and is essential to ensure accurate measurements.

6. If the etCO<sub>2</sub> sampling line dialog appears on your screen, watch the animation and confirm that you have connected the sampling line correctly, then touch **OK** to dismiss the dialog.
7. Connect the sampling line to the patient as described in the directions for use supplied with the sampling line.
8. Perform the following checks:
  - a. Check that CO<sub>2</sub> values appear on the monitor.
  - b. Check the patient type. Make sure it is correct to ensure accurate sampling.
  - c. Touch the alarm control to ensure the alarms are set appropriately.

- d. Toggle to the waveform view to ensure that a complete waveform appears.

- Note** When the cannula is not on the patient, the etCO<sub>2</sub> value is 0.
- Note** After you connect the sampling line, the monitor immediately searches for breaths, but it does not indicate a No Breath condition before any valid breaths have been detected.
- Note** To avoid moisture buildup and sampling line occlusion during suction or nebulization of intubated patients, stop the CO<sub>2</sub> pump and remove the sampling line luer connector from the monitor.
- Note** Replace the sampling line according to hospital protocol or when a blockage is indicated by the device. Excessive patient secretions or a buildup of liquids in the airway tubing might occlude the sampling line, requiring more frequent replacement.
- Note** When the message "Occlusion in the gas line" appears on the screen, indicating that the sampling line attached to the monitor is blocked, the monitor's CO<sub>2</sub> pump will stop. Follow the instructions in the Troubleshooting section of this manual to correct the problem.

## Stop and restart the CO<sub>2</sub> pump

Stopping the CO<sub>2</sub> pump prevents the ingress of fluids into the CO<sub>2</sub> module during certain patient procedures (such as suction or lavage). In addition, this pump-stop condition pauses the monitoring of all parameters obtained from the CO<sub>2</sub> module for a configured period of time or until you restart the CO<sub>2</sub> pump.

1. To temporarily pause or stop CO<sub>2</sub> monitoring, touch the pump-stop button  in the etCO<sub>2</sub> frame.

- Note** This button is a toggle. When you stop the CO<sub>2</sub> pump, the Start button with a countdown timer appears.

2. To resume CO<sub>2</sub> monitoring, touch the pump-start button .

The CO<sub>2</sub> pump restarts, the current timer clears, and the Stop button appears in the frame.

## Respiration rate

### RR frame

The RR frame displays the following:

- Respiration rate in breaths per minute (BPM)
- Alarm limit control

- Note** RR monitoring is available only in the Continuous Monitoring profile.

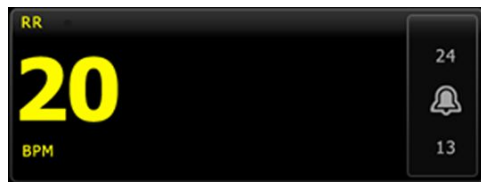

## Set up RR

Default settings for the **RR** parameter can be changed only in Advanced settings.

## Configure RR alarms

Follow these steps to set alarm limits for RR measurements.

1. Verify that you are using the Continuous Monitoring profile.
2. Touch the **Alarms** tab.
3. Touch the **RR** vertical tab.
4. Ensure that the RR alarm limit control is set to ON.

**Note** If any parameter's alarm limit control is set to OFF, you cannot adjust alarm limits on the Alarm tab, and no visual or audio signals will occur for that specific parameter.

5. Adjust the following settings as desired:
  - RR limits. Enter upper and lower alarm limits for RR using the up/down arrow keys or the keypad.
  - High alarm delay. Select the duration from the list box. This alarm delay specifies the minimum duration of a high alarm limit condition to activate an alarm signal. You can set the default in Advanced settings.
  - No breath detected alarm delay. Select the duration from the list box. This alarm delay specifies the minimum duration of a no-breath condition to activate an alarm signal. You can set the default in Advanced settings.
6. Touch the **Home** tab.

The new alarm settings take effect immediately.

## IPI

The Integrated Pulmonary Index (IPI) integrates four parameters and their interactions to provide a numeric value indicating a patient's overall respiratory status. The integrated parameters are etCO<sub>2</sub>, RR, SpO<sub>2</sub>, and PR. The additional status information provided by IPI enables you to intervene before values of individual parameters reach levels of clinical concern.

**Note** IPI is available for adult patients as well as three groups of pediatric patients (1–3 years, 3–6 years, and 6–12 years), but it is not available for neonatal/infant patients.

**Note** Pediatric patient subtypes appear on the Patient Summary tab and on the Home tab as a label in the IPI frame, but they do not appear in the Patient frame.

**Note** IPI is available only with the Continuous Monitoring profile.

The range of IPI is 1–10. These values can be interpreted as indicated in the following table.

Index range	Patient status
10	Normal
8–9	Within normal range
7	Close to normal range; requires attention
5–6	Requires attention and may require intervention
3–4	Requires intervention
1–2	Requires immediate intervention

Source: *The microMediCO2 Module - OEM Manufacturers' Integration Guide* (p. 13), Oridion Medical 1987 Ltd.

**Note** The interpretation of a patient's IPI value might change in different clinical conditions. For example, patients who have a history of respiratory difficulties might require a lower IPI Low Alert threshold that takes into account their diminished respiratory capacity.

## IPI frame

The IPI frame displays a numeric value from 1–10 as well as an alarm threshold and control.

The frame provides a numeric view and a graphical trend view of IPI data. You can toggle between views by touching the left side of the frame.

### IPI numeric view

This view displays the numeric value for the integrated parameters.

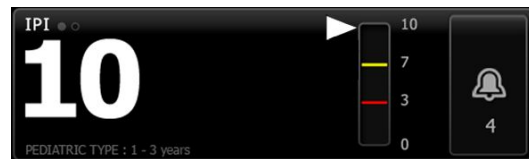

The numeric view also includes a graphic indicator of the patient's current IPI value. As shown in the examples below, when the IPI value is 8, 9, or 10, the outline of the vertical bar is gray. When the IPI value is 4, 5, 6, or 7, the outline of the bar is yellow, and the middle section of the bar is shaded yellow. When the IPI value is 1, 2, or 3, the outline of the bar is red, and the lowest section of the bar is shaded red.

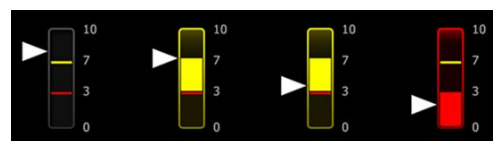

## IPI trend graph view

This view presents a graph of the IPI numeric values over a user-selected period and thus can alert you to changes in the patient's respiratory status. In Advanced settings, you can select the period displayed.

The size of the IPI frame and displayed trend data varies based on your configuration.

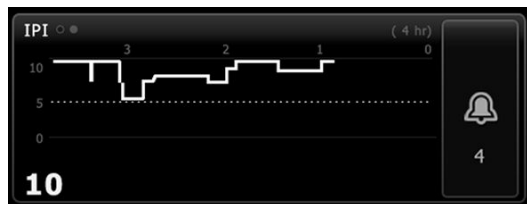

The graph shows the IPI value on the y-axis and time on the x-axis (oldest calculations on the left and newest calculations on the right). IPI values update once every second.

## Set up IPI

Follow these steps to configure IPI parameter options.

1. Touch the **Settings** tab.
2. Touch the **Setup** tab.
3. Touch the **IPI** vertical tab.
4. Adjust the Trend period as desired. You can set the default in Advanced settings.
5. Touch the **Home** tab.

The new settings take effect immediately.

6. Touch the patient type control on the right side of the Patient frame.

The Patient Summary tab appears.

**Note** IPI is available for adult patients as well as three groups of pediatric patients (1–3 years, 3–6 years, and 6–12 years), but it is not available for neonatal/infant patients.

**Note** If you are monitoring a pediatric patient, the following additional considerations apply when you select patient type: Pediatric patients fall into one of three types based on their age: Ped 1–3, Ped 3–6, Ped 6–12. Because these age ranges overlap, consider details such as patient size and birth date to select Pediatric patient type.



**CAUTION** The characteristics of a breath are calculated differently for different patient types. Incorrect patient type selections cause inaccurate monitoring of the patient's respiration rate and affect the patient's IPI value.

7. Touch the Type list box and select patient type.

The screenshot shows a software interface for patient monitoring. At the top, a blue banner contains an information icon and the text "Age range required to monitor IPI". Below this are three tabs: "List", "Summary", and "Manual". The "Summary" tab is active. The interface is divided into several sections:
 

- Patient Information:** Includes fields for "Last name" (Barker), "First name" (David), and "Middle initial" (A).
- Age Range Selection:** A dropdown menu is open, showing options: "Adult", "Pediatric", "Pediatric 1-3", "Pediatric 3-6", "Pediatric 6-12", and "Neonate".
- Location:** A dropdown menu shows "Room and bed" with the value "200B".
- Buttons:** "OK" and "Clear" buttons are located at the bottom right of the form area.
- Navigation Bar:** At the bottom, there are tabs for "Home", "Patients", "Alarms", "Review", and "Settings".

**Note** As shown here, an information message prompts you to select a pediatric age range when you monitor IPI on pediatric patients.

8. Touch **OK**.

The Home tab appears.

**Note** Pediatric patient subtypes appear on the Patient Summary tab and on the Home tab as a label in the IPI frame, but they do not appear in the Patient frame.

## Configure IPI alarms

Follow these steps to set alarm limits for IPI.

1. Verify that you are using the Continuous Monitoring profile.
2. Touch the **Alarms** tab.
3. Touch the **IPI** vertical tab.
4. Ensure that the Limits control is set to ON.

**Note** If any parameter's alarm limit control is set to OFF, you cannot adjust alarm limits on the Alarm tab, and no visual or audio signals will occur for that specific parameter.

5. Adjust the IPI limits setting as desired. Enter the desired lower alarm limit for IPI using the up/down arrow keys or the keypad.
6. Touch the **Home** tab.

The new alarm settings take effect immediately.

## Acoustic respiration rate (RRa)

Monitors configured with Masimo rainbow Acoustic Monitoring technology continuously and noninvasively measure respiration rate based on respiratory sounds produced in the upper airway. Respiratory sounds are detected through a sensor applied to the patient's neck.

- Note** RRa is available only in the Continuous Monitoring profile.
- Note** Masimo SpO2 monitoring is required when monitoring RRa.
- Note** RRa monitoring is only for adult patients who weigh more than 66 pounds (30 kilograms).
- Note** Monitors configured with RRa cannot be configured with CO2.

## RRa frame

The RRa frame displays the following:

- Respiration rate in breaths per minute (BPM)
- Respiration Indicator
- Alarm limit control
- Averaging control toggle providing the options of slow, medium, fast, trending, and off

**Note** RRa is available only when the Continuous Monitoring profile and Adult patient type are selected.



## Respiration Indicator

The Respiration Indicator displays the level of sound detected by the RRa sensor. A higher level of sound causes more bars to illuminate.



## Averaging selector

The averaging selector enables you to choose the desired visibility of subtle variations in RRa measurements. You can adjust averaging in the RRa frame by touching the

averaging selector . Use this control toggle to select an averaging option (off, slow, medium, fast, or trending) while acquiring readings.

### Averaging selector options



Off



Fast  
~10 seconds



Medium  
~20 seconds



Slow  
~30 seconds



Trending  
~60 seconds



You can set the RRa averaging default in Advanced settings. Averaging is set to default settings when any of the following occurs:

- The device starts up
- You change or clear patient context

## Set up RRa

Default settings for the **RRa** parameter can be changed only in Advanced settings.

## Configure RRa alarms

Follow these steps to set alarm limits for RRa measurements.

1. Verify that you are using the Continuous Monitoring profile.
2. Verify that the patient type is Adult.
3. Touch the **Alarms** tab.
4. Touch the **RRa** vertical tab.
5. Ensure that the RRa alarm limit control is set to ON.

**Note** If any parameter's alarm limit control is set to OFF, you cannot adjust alarm limits on the Alarm tab, and no visual or audio signals will occur for that specific parameter.

6. Adjust the following settings as desired:
  - RRa limits. Enter upper and lower alarm limits for RRa using the up/down arrow keys or the keypad.
  - Alarm delay. Select the duration from the list box. This alarm delay specifies the minimum duration of an alarm limit condition to activate an alarm signal. The alarm delay you select impacts both upper and lower alarm limits. You can set the default in Advanced settings.
  - No breath detected alarm delay. Select the duration from the list box. This alarm delay specifies the minimum duration of a no-breath condition to activate an alarm signal. You can set the default in Advanced settings.
7. Touch the **Home** tab.

The new alarm settings take effect immediately.

## Measure RRa

RRa monitoring is only for adult patients who weigh more than 66 pounds (30 kilograms).



**WARNING** Inaccurate measurement risk. Use only Masimo rainbow SET sensors and accessories on Masimo-equipped monitors.



**WARNING** The accuracy of RRa measurements can be affected by any of the following:

- Excessive ambient or environmental noise
- Improper sensor placement
- Failure to properly connect the sensor and cables



**WARNING** Masimo SpO2 monitoring is required when monitoring RRa.



**WARNING** Patient injury risk. Do not attempt to reprocess, recondition, or recycle any sensors or patient cables. Doing so might damage electrical components.



**WARNING** Patient injury risk. The sensor and extension cable are intended only for connection to pulse co-oximetry equipment. Do not attempt to connect these cables to a PC or any similar device. Always follow the sensor manufacturer's directions for care and use of the sensor.

Before you begin, read the RRa sensor directions for use.

1. Verify that the dual cable is connected to the monitor and to the SpO2 cable and the RRa cable. If a sensor is connected to the RRa cable, disconnect the sensor from the cable.

**Note** When the RRa sensor is off the patient and is connected to the monitor, the sensor might pick up periodic ambient sounds and report a measurement.

2. Verify that you are using the Continuous profile.
3. Verify that the patient type is Adult.
4. Verify that the alarms are set appropriately.
5. Start monitoring SpO2 as described in this directions for use.
6. Attach the RRa sensor to the patient according to the manufacturer's directions for use, observing all warnings and cautions.

**Note** The sensor is for single-patient use only. You can reuse the sensor on the same patient if it is clean and dry, and the adhesive still adheres to the skin. Otherwise, use a new sensor. Do not reuse the sensor on another patient.

**Note** Do not use disposable sensors on patients who have allergic reactions to the adhesive.

7. Connect the RRa sensor to the RRa cable.
8. Confirm that the monitor displays RRa data within approximately 60 seconds of connection to the patient.



**WARNING** Patient injury risk. Incorrect sensor application or excessive duration of sensor use can cause tissue damage. Inspect the sensor site periodically as directed in the sensor manufacturer's instructions.

Detaching the sensor during a measurement triggers an alarm.

## NIBP

### Noninvasive Blood Pressure (NIBP) frame

From the NIBP frame, you can measure blood pressure.

The NIBP frame contains data and features relevant to noninvasive blood pressure measurement. The frame provides different features based on the profile you are using.

### NIBP frame in Continuous Monitoring profile



The size of the NIBP frame and displayed measurements varies based on your configuration.

The Continuous Monitoring profile also provides a visual indication of aging episodic measurements (those more than 16 minutes old) and a timestamp indicating the time of the measurement. When a NIBP measurement is displayed for more than 16 minutes, the numerics on the screen change from their current color to gray. After one hour, these measurements are cleared from the frame.

### NIBP frame in Intervals Monitoring profile



### NIBP frame in Spot Check and Triage profiles





### NIBP measurement display

In all profiles, the frame can display systolic and diastolic measurements, and MAP calculations. You can configure the default view in Advanced settings.





### View indicator

Touch the NIBP frame to toggle between views.

- NIBP view 1  displays the SYS/DIA measurements as the primary content and the MAP calculation as secondary content.
- NIBP view 2  displays the MAP calculation as the primary content and the SYS/DIA as secondary content.

## Buttons

The buttons on the right side of the frame enable you to do different tasks depending on the profile you are using. The availability of functions depends on which profile is selected. See the Profiles section for more information.

Button name	Button image	Description
Start/Stop		Touch to start a manual measurement or a cycle of automatic measurements.
		Touch to stop a measurement that is in progress.
Interval		Automatic measurements are off.
		Automatic measurements are on.
Alarm Limit control		Touch the button to display the Alarms tab.

## Select a cuff



**WARNING** Use only blood pressure cuffs and hoses listed as approved accessories to ensure safe and accurate NIBP measurements.



**WARNING** Never use an adult or pediatric monitor setting or cuff for an NIBP measurement on a neonatal patient. Adult and pediatric inflation limits can be excessive for neonatal patients, even if a neonatal cuff is used. Neonates are defined in the AAMI SP10:2002 standard as children 28 days or less of age if born at term (37 weeks gestation or more); otherwise, up to 44 gestational weeks.



**CAUTION** Correct sizing of the blood pressure cuff is important for accurate blood pressure readings. A cuff that is too small might provide false high readings, while a cuff that is too large might provide false low readings.

The monitor uses the oscillometric method to determine blood pressure; therefore, if the cuff extends to the antecubital fossa (bend in the elbow), you can still acquire an accurate blood pressure reading.

Before taking an NIBP measurement, follow these steps to select the appropriate cuff for the patient.

1. Measure the circumference of the patient's bare upper arm, midway between the elbow and shoulder.
2. Choose the appropriate cuff size based on the circumference measurement. If the circumference of the patient's arm falls between two cuff sizes, use the larger cuff size.
3. Wrap the cuff around the patient's bare upper arm and verify that the artery index marker lies somewhere between the two range markings on the cuff.

## Cuff measurements

The following tables provide measurements for Welch Allyn blood pressure cuffs.

### One-piece cuff measurements

Cuff Size	Circumference (cm)	Circumference (in)
Infant	9.0 – 13.0	3.5 – 5.1
Small child	12.0 – 16.0	4.7 – 6.3
Child	15.0 – 21.0	5.9 – 8.3
Small adult	20.0 – 26.0	7.9 – 10.2
Adult	25.0 – 34.0	9.8 – 13.4
Large adult	32.0 – 43.0	12.6 – 16.9
Thigh	40.0 – 55.0	15.7 – 21.7

### Neonatal soft disposable cuffs with male Luer slips

Cuff Size	Circumference (cm)	Circumference (in)
NEO 1	3.3 – 5.6	1.3 – 2.2
NEO 2	4.2 – 7.1	1.6 – 2.8
NEO 3	5.4 – 9.1	2.1 – 3.6
NEO 4	6.9 – 11.7	2.4 – 4.6

Cuff Size	Circumference (cm)	Circumference (in)
NEO 5	8.9 – 15.0	3.5 – 5.9
Multi-pack	1 of each	1 of each

For ordering information, see *Approved Accessories* on the CD.

## Position the cuff

**Note** The monitor and cuffs were validated using the bare upper arm site.



**WARNING** Patient injury risk. Do not use the NIBP for continuous monitoring without frequently checking the patient's limb. When a patient is being monitored frequently or for a prolonged period, regularly remove the cuff to inspect it and to check the cuff site for ischemia, purpura, or neuropathy.



**WARNING** Inaccurate measurement risk. Do not place the cuff where it can disturb proper circulation. Do not place the cuff on any area where circulation is compromised or on any extremity used for intravenous infusions. Do not use an SpO2 finger clip sensor and a blood pressure cuff simultaneously on the same limb. Doing so may cause a temporary loss of pulsatile flow, resulting in either no reading or an inaccurate SpO2 or pulse rate until the flow returns.



**WARNING** The blood pressure cuff must be properly positioned to ensure blood pressure accuracy and patient safety. Wrapping the cuff too loosely (preventing proper inflation) may result in inaccurate NIBP readings.



**CAUTION** If a site other than the bare upper arm is used, the blood pressure measurements may be different. It is important to document the alternate site on the patient record.



**CAUTION** To minimize inaccurate measurement, limit patient movement during an NIBP measurement cycle.

Before taking an NIBP measurement, follow these steps to properly attach the cuff to the patient.

1. Check the cuff for residual air from a previous measurement. Squeeze the cuff as needed to completely deflate the cuff.
2. Position the cuff on the patient's bare upper arm midway between the shoulder and the elbow.
3. Wrap the cuff snugly so that there is room for no more than two fingers between the cuff and the patient's bare upper arm.
4. Position the alignment mark on the cuff directly over the brachial artery.
5. Ensure that the blood pressure tubing has no kinks or twists.

**Note** In situations where you cannot position the cuff level with the heart, you should adjust the measurements as follows for greater accuracy. For each inch (2.54 cm) that the cuff is above the level of the heart, add 1.8 mmHg to the displayed reading. For each inch (2.54 cm) that the cuff is below the level of the heart, subtract 1.8 mmHg from the displayed reading. It is important to document the adjustment on the patient record.

## Set up NIBP

Follow these steps to configure NIBP parameter settings.

1. Touch the **Settings** tab.
2. Touch the **Setup** tab.
3. Touch the **NIBP** vertical tab.
4. Adjust the following settings as desired:
  - Cuff site. Select the site from the list box.
  - Cuff size. Select the size from the list box.
  - Patient position. Select the position from the list box.
  - Cuff inflation target. If the monitor is set up for StepBP, enter the Cuff inflation target. You can set the default in Advanced settings.
5. Touch the **Home** tab.

The new settings take effect immediately.

## Configure NIBP alarms

Follow these steps to set alarm limits for systolic and diastolic measurements, and MAP calculation.

1. Verify that you are using the Intervals Monitoring or Continuous Monitoring profile.
2. Touch the **Alarms** tab.
3. Touch the **NIBP** vertical tab.
4. Ensure that the NIBP and MAP alarm limit controls are set to ON.

**Note** If any parameter's alarm limit control is set to OFF, you cannot adjust alarm limits on the Alarm tab, and no visual or audio signals will occur for that specific parameter.

5. Adjust the following settings as desired:
  - Systolic. Enter upper and lower Systolic alarm limits using the up/down arrow keys or the keypad.
  - Diastolic. Enter upper and lower Diastolic alarm limits using the up/down arrow keys or the keypad.
  - MAP. Enter upper and lower MAP alarm limits using the up/down arrow keys or the keypad.
6. Touch the **Home** tab.

The new alarm settings take effect immediately.

## NIBP measurement

The monitor enables you to take manual and automatic NIBP measurements.



**WARNING** NIBP readings may be inaccurate for patients experiencing moderate to severe arrhythmia.



**WARNING** Do not allow a blood pressure cuff to remain on neonatal patients more than 90 seconds when inflated above 5 mmHg. Do not allow a blood pressure cuff to remain on the adult patients more than 3 minutes when inflated above 15 mmHg. Excessive cuff tightness may cause venous congestion, peripheral nerve injury, discoloration of the limb, and patient distress.



**WARNING** Inaccurate measurement risk. Pulse rate measurements generated through the blood pressure cuff or through SpO2 are subject to artifact and might not be as accurate as heart rate measurements generated through ECG or through manual palpation.



**WARNING** Use caution when measuring blood pressure using oscillometric blood pressure devices in severely ill neonates and pre-term infants because these devices tend to measure high in this patient population.



**CAUTION** Inaccurate measurement risk. Any external compression of the blood pressure hose or cuff may cause system errors or inaccurate measurements.

At the start of a measurement, the monitor inflates the cuff to the appropriate level. In the NIBP frame, the systolic display shows the cuff inflation pressure while the blood pressure measurement is in progress.

The monitor measures blood pressure as the cuff is inflating. If patient movement, excessive noise, or an arrhythmia prevent the monitor from determining the blood pressure while the cuff is inflating, the monitor attempts to measure the blood pressure while deflating the cuff.

When the measurement is complete, the NIBP frame displays the measurement until you save it to the patient's record or you start another NIBP measurement.

**Note** The Pediatric and Adult blood pressure modes are supported on patients 29 days and older. The Pediatric mode gives you the option of setting a lower initial inflation pressure when using the StepBP deflation and not SureBP.

**Note** Use dual-lumen tubes for adult and pediatric blood pressure measurements and single-lumen tubes for neonate blood pressure measurements. Mismatching tube types, patient types, and algorithms causes an information message to appear in the Device Status area. For neonate patients, set the NIBP settings as follows: Patient = Neonate, Tube type = 1 tube, Algorithm = Step.

**Note** Welch Allyn uses the following definition of Neonate: Children 28 days or less of age if born at term (37 gestation or more); otherwise, up to 44 gestational weeks.



## Take a manual NIBP measurement



**WARNING** Patient injury risk. Never install Luer Lock connectors on Welch Allyn blood pressure cuff tubing. Using these connectors on blood pressure cuff tubing creates the risk of mistakenly connecting this tubing to a patient's intravenous line and introducing air into the patient's circulatory system.



**CAUTION** Inaccurate measurement risk. Any external compression of the blood pressure hose or cuff may cause system errors or inaccurate measurements.

1. Properly size the blood pressure cuff and position it around the patient's bare upper arm.
2. Touch **Start** to take a measurement.

## Cancel a measurement that is in progress

Follow these steps to cancel any NIBP measurement that is in progress.



On the Home tab, touch

The monitor rapidly deflates the cuff, and the screen displays the NIBP cancellation message.

## Interval NIBP measurement

The monitor can take NIBP measurements automatically based on intervals you choose.

The Intervals tab provides all interval features.



From this tab, you can do the following:

- Configure intervals
- Turn off intervals
- Configure the monitor to print automatic measurements as they are completed

When the measurement is complete, the NIBP frame displays the measurement until the next measurement is complete.

**Note** During intervals, each automatic and manual save of patient measurements clears all measurements from Manual parameters frame.



The  button changes to a timer (  ), which counts down to the next automatic measurement.

Automatic measurements continue until you turn off intervals.



**WARNING** Patient harm risk. Do not use intervals on neonates out of earshot. Verify that audio can be heard from where you intend to be.

## Set up NIBP intervals

Follow these steps to configure NIBP intervals.

1. Touch the **Settings** tab.
2. Touch the **Setup** tab.
3. Touch the **Intervals** vertical tab.
4. Select **Automatic**, **Program**, or **Stat**, and follow the steps presented in the associated topics that follow.
5. To automatically print patient data at each interval, touch the **Automatic print on interval** checkbox.
6. To start intervals immediately, touch **Start intervals**. Otherwise, touch the **Home** tab.

The new settings take effect immediately.

## Automatic intervals

You can configure the monitor to take automatic NIBP measurements at consistent intervals. Use the spin box or keypad to set the desired interval.

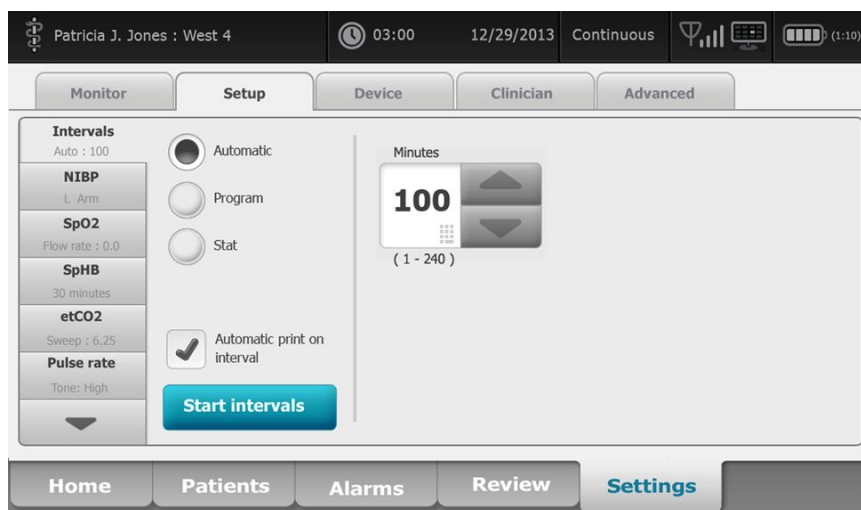

**Note** An alarm does not turn off intervals. Subsequent automatic measurements continue to occur as scheduled.

## Start automatic intervals

Follow these steps to configure the monitor to take NIBP measurements at consistent intervals.

1. Properly size the blood pressure cuff and position it around the patient's bare upper arm.



2. On the Home tab, touch the Home button.
3. Select **Automatic**.
4. Use the numeric keypad to enter the length of time between NIBP measurements.
5. Touch **Start intervals**.

**Note** Intervals are not available in all profiles. See the Profiles section for more information.

## Program intervals

You can configure the monitor to take automatic NIBP measurements at variable intervals. The monitor comes with preset interval programs that can be edited to meet your needs. You can rename selected programs using the keyboard feature. The columns below the selected program name indicate the length of each interval in the cycle (Interval) and the number of intervals you set (Frequency).

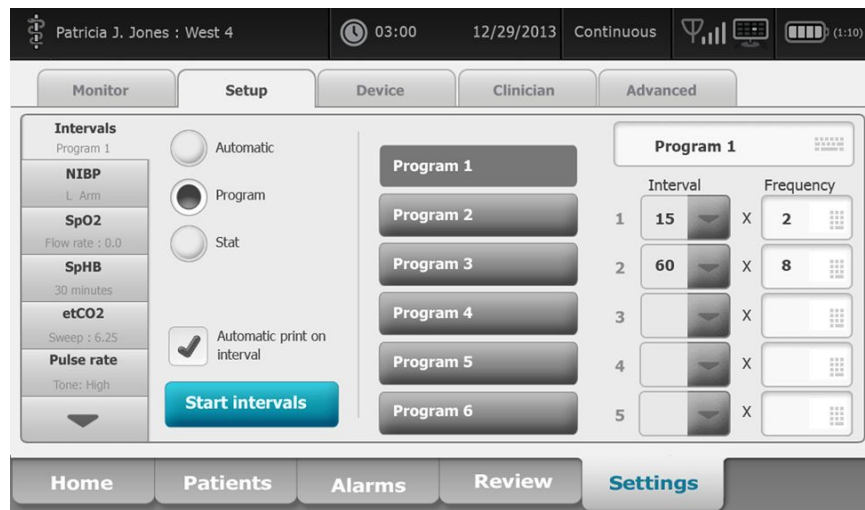

## Start program intervals

Follow these steps to configure the monitor to take automatic NIBP measurements at variable intervals.



1. Properly size the blood pressure cuff and position it around the patient's bare upper arm.



2. On the Home tab, touch .
3. Select **Program**.
4. Touch the desired program.
5. Touch **Start intervals**.

## Create a new program interval or edit an existing program

Follow these steps to create or edit a program interval.

1. On the Home tab, touch the interval button ( or .
2. Select **Program**.
3. Touch the desired program.
4. Touch the keyboard icon and enter the desired program name.
5. Enter the desired interval and frequency settings.
6. Touch **Start Intervals**.

The new intervals take effect at the start of the next NIBP measurement.

## Stat intervals

You can configure the monitor to take NIBP measurements continuously.

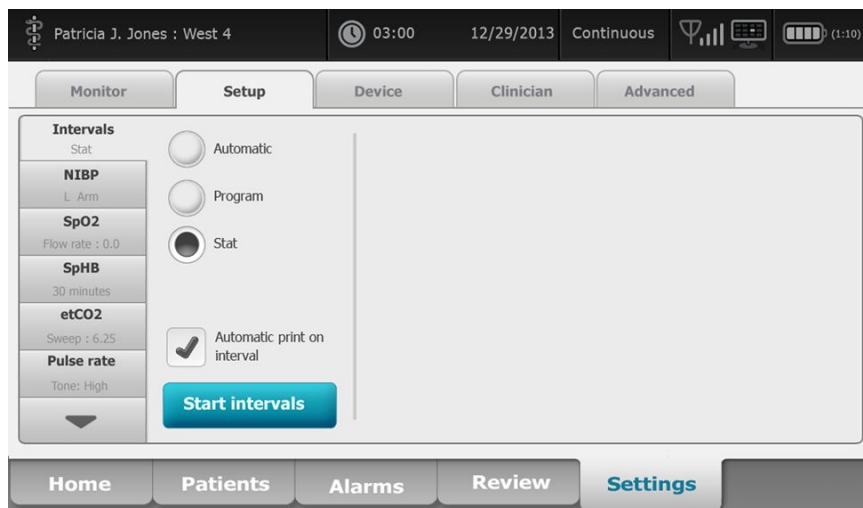

When you select the Stat option, the monitor takes repeated NIBP measurements for 5 minutes, starting a new cycle each time the cuff deflates below safe venous return pressure (SVRP) for 2 seconds.



**WARNING** Patient injury risk. If you use Stat mode repeatedly, periodically observe the patient's limb to ensure that circulation is not impaired and that the cuff remains in place. Prolonged impairment of circulation or improper cuff position can cause bruising.

Current cuff pressures are not dynamically displayed during a Stat reading. The Home tab displays the NIBP reading from the previous cycle until the current cycle finishes.

**Note** If you are in Stat intervals, you can stop intervals by touching



## Start Stat intervals

Follow these steps to start Stat intervals.

1. Properly size the blood pressure cuff and position it around the patient's bare upper arm.



2. On the Home tab, touch .
3. Select **Stat**.
4. Touch **Start intervals**.

The Home tab appears with the intervals timer counting down from 0:05:00.

## Stop intervals measurements

Follow these steps to turn off intervals.

1. On the Home tab, touch the interval timer button ().

**Note** The actual time remaining varies based on the length of the selected interval and the time expired.

2. Touch **Stop intervals**.

**Note** If you are in Stat intervals, you can also stop intervals on the Home tab by



touching

## Temperature

### Temperature frame

From the temperature frame you can measure patient temperature.

The temperature frame contains data and features relevant to temperature measurement. The frame provides different features based on the profile you are using.

### Temperature frame in Continuous Monitoring profile

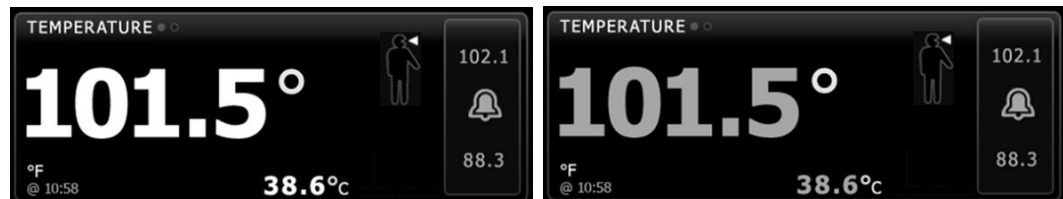

The size of the Temperature frame and displayed measurements varies based on your configuration.

The Continuous Monitoring profile also provides a visual indication of aging episodic measurements (those more than 16 minutes old) and a timestamp indicating the time of the measurement. When a temperature measurement is displayed for more than 16 minutes, the numerics on the screen change from their current color to gray. After one hour, these measurements are cleared from the frame.

### Temperature frame in Intervals Monitoring profile



## Temperature frame in Spot Check and Triage profiles



## Temperature measurement display

In all profiles, the frame can display temperature in Celsius or Fahrenheit. You can configure the default view in Advanced settings.

## Site selection

Remove the temperature probe and touch the **Temperature site control**  to toggle between sites.

### Pediatric axillary



### Adult axillary



### Oral



**Note** Monitors configured with the temperature module and the red rectal probe well and probe default to the rectal mode.

### Rectal





**Note** The monitor displays the tympanic mode when it receives a temperature measurement from the ear thermometer.

### Ear



## Temperature buttons

The buttons on the right side of the frame enable you to do different tasks depending on the profile you are using. The availability of functions depends on which profile is selected.

Button name	Button image	Description
Temperature alarm		This button displays alarm status. It also displays alarm limits in some device configurations. Touch the button to display the Alarms tab.
Direct mode		Touch the button to enter Direct mode.

## Set up temperature

If the monitor is set up to record temperature measurements as a manual parameter, follow these steps to configure temperature parameter settings.

1. Touch the **Settings** tab.
2. Touch the **Setup** tab.
3. Touch the **Temperature** vertical tab.
4. Select the desired Measurement site from the list box. You can set the default in Advanced settings.
5. Touch the **Home** tab.

The new settings take effect immediately.

## Configure temperature alarms

Follow these steps to set alarm limits for temperature measurement.

1. Verify that you are using the Intervals or Continuous profile.
2. Touch the **Alarms** tab.
3. Touch the **Temperature** vertical tab.
4. Ensure that the Temperature alarm limit control is set to ON.

**Note** If any parameter's alarm limit control is set to OFF, you cannot adjust alarm limits on the Alarm tab, and no visual or audio signals will occur for that specific parameter.

5. Adjust the Temperature limits as desired. Enter the desired upper and lower alarm limits for temperature using the up/down arrow keys or the keypad.
6. Touch the **Home** tab.

The new alarm settings take effect immediately.

## SureTemp® Plus temperature module

The temperature module uses a thermistor thermometer design and a predictive algorithm to calculate patient temperatures in the Predictive mode.



**WARNING** Patient injury risk. Prior to taking a temperature, instruct the patient not to bite down on the probe as patient injury and damage to the probe may result.



**WARNING** Patient injury risk. Do not exceed the recommended temperature measurement durations in Direct mode. Continuous measurement durations of 3 minutes at the oral and rectal sites and 5 minutes at the axillary site are recommended for accurate measurement. Do not continuously measure beyond 10 minutes in any mode.



**WARNING** Probe covers are single-use only. Re-use of a probe cover may result in spread of bacteria and cross-contamination.



**WARNING** Patient injury risk. Use only Welch Allyn single-use disposable probe covers. Never take a temperature measurement without a single-use probe cover securely attached. Failure to use a probe cover can cause patient discomfort from a heated probe, patient cross-contamination, and inaccurate temperature readings.



**WARNING** Patient illness may result from improper use of oral and rectal temperature probes. Using the incorrect probe may also produce inaccurate measurements.

- Use only oral probes, identified by a blue ejection button at the top of the probe, to take oral and axillary temperatures.
- Use only rectal probes, identified by a red ejection button at the top of the probe, to take rectal temperatures.



**WARNING** Patient illness or cross-contamination may result from improper placement of oral and rectal temperature probes in the probe wells.

- Place only oral probes, identified by a blue ejection button at the top of the probe, in the blue probe wells.
- Place only rectal probes, identified by a red ejection button at the top of the probe, in the red probe wells.



**WARNING** Inaccurate measurement risk. Never take an axillary temperature through the patient's clothing. Carefully place the probe in the axilla, avoiding contact with other objects or material. Always verify direct contact between the probe cover and skin.



**WARNING** Patient injury risk. When taking rectal temperatures, insert the probe tip only 5/8 inch (approximately 1.5 cm) inside the rectum of adults and only 3/8 inch (approximately 1 cm) inside the rectum of children to avoid the risk of bowel perforation.





**WARNING** Never use a damaged temperature probe. The thermometer consists of high-quality precision parts and should be protected from severe impact or shock. Do not use the thermometer if you notice any signs of damage to the probe or monitor. If the thermometer probe is dropped or damaged, remove it from use and have it inspected by qualified service personnel.



**CAUTION** Inaccurate measurement risk. Patient activities such as strenuous exercise, ingesting hot or cold liquids, eating, chewing gum or mints, brushing teeth, or smoking may affect oral temperature measurements for up to 20 minutes.



**CAUTION** Inaccurate measurement risk. Always use new probe covers taken from the monitor's probe cover box holder to ensure accurate temperature measurements. Probe covers taken from other places or that haven't stabilized in temperature may result in inaccurate temperature measurements.

## Temperature mode selection

The monitor with the temperature module takes a patient temperature in either Predictive (Normal) or Direct mode. The default setting is the Predictive mode.



**WARNING** Inaccurate measurement risk. To ensure optimal accuracy, always confirm that the correct mode and site are selected.



**WARNING** Patient injury risk. Do not exceed the recommended temperature measurement durations in Direct mode. Continuous measurement durations of 3 minutes at the oral and rectal sites and 5 minutes at the axillary site are recommended for accurate measurement. Do not continuously measure beyond 10 minutes in any mode.

### Predictive mode

Is a one-time measurement that takes a temperature in approximately 6 to 15 seconds. Removing the probe from the probe well, loading a probe cover, and holding the probe tip in place at the measurement site initiates a Predictive mode measurement. The monitor sounds a tone to indicate the end of a predictive measurement.

### Direct mode

Provides continual temperature measurements. For oral and rectal measurements, it is recommended to measure temperature until the temperature stabilizes or for 3 minutes. For axillary measurements, it is recommended to measure temperature until the temperature stabilizes or for 5 minutes. The monitor changes to Direct mode approximately 60 seconds after the probe is removed from the probe well.

**Note** The monitor does not retain Direct mode temperatures in memory. Therefore, it is important to note the temperature before removing the probe from the measurement site and then manually record it in the patient record.

After 10 minutes of using the Direct mode, the monitor generates a technical alarm condition and clears the measurement.

## Take a temperature in the Predictive mode



**WARNING** Inaccurate measurement risk. To ensure optimal accuracy, always confirm that the correct mode and site are selected.



**WARNING** Patient injury risk. Prior to taking a temperature, instruct the patient not to bite down on the probe as patient injury and damage to the probe may result.



**CAUTION** Probe covers are disposable, nonsterilized, and single-use. Probes are also nonsterilized. Do not autoclave probes and probe covers. Ensure that probe covers are disposed of according to facility requirements or local regulations.

1. Remove the temperature probe from the probe well.  
The monitor sounds a tone as it enters the ready state.
2. Insert the probe into a new probe cover and press the probe handle down firmly.
3. Touch the **Temperature site control**  to choose from these measurement sites: oral, pediatric axillary, or adult axillary.
4. Hold the probe tip in place at the measurement site.

For oral temperatures, place the probe tip under the patient's tongue on either side of the mouth to reach the sublingual pocket and ask the patient to close his/her lips.

**Note** Do not hand the probe to patients to place in their mouth.

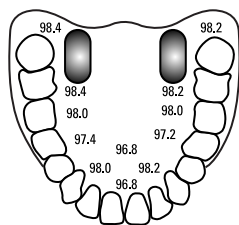

For axillary temperatures, lift the patient's arm so that the entire axilla is easily seen and place the probe tip as high as possible in the mid-axilla. Verify that axillary tissue completely surrounds the probe tip and place the arm snugly at the patient's side.

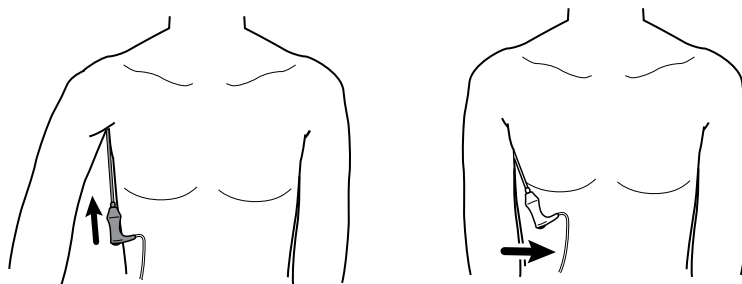

While the measurement is taking place, the temperature frame displays the process indicator.



- The monitor sounds a tone when the final temperature is reached (in approximately 6 to 15 seconds). The temperature frame continues to display the temperature even after the probe is returned to the probe well.



**Note** To switch to the Direct mode, touch  after you acquire the Predictive mode measurement. The temperature frame displays text indicating that the Direct mode is active.

The monitor sounds a tone at the start of a Direct mode measurement.

- Remove the probe after the temperature measurement is complete and firmly press the eject button on the top of the probe to release the probe cover.



**WARNING** Patient injury risk. Do not exceed the recommended temperature measurement durations in Direct mode. Continuous measurement durations of 3 minutes at the oral and rectal sites and 5 minutes at the axillary site are recommended for accurate measurement. Do not continuously measure beyond 10 minutes in any mode.

Ensure that probe covers are disposed of according to facility requirements or local regulations.

- Return the probe to the probe well.
- Wash your hands to reduce the risk of cross-contamination.

## Take a temperature in the Direct mode

Direct mode displays the temperature of the probe as long as the probe tip remains in place at the measurement site and remains within the operating patient temperature range. The patient's temperature will reach final equilibrium in approximately 3 minutes at the oral and rectal measurement sites and approximately 5 minutes at the axillary site.

The monitor enters Direct mode by the following methods.

- After you complete a Predictive mode measurement, touch  to switch from Predictive to Direct mode. The temperature frame displays text indicating that the Direct mode is active.
- Remove the probe from the probe well, load a probe cover, select a temperature site, and expose the probe to ambient air for more than 60 seconds to switch the monitor to Direct mode. The temperature frame displays text indicating that the Direct mode is active.
- If you have a patient whose body temperature is below the normal temperature range and you follow the previous step, the probe sensor identifies this condition and turns off the probe preheater in order to accommodate the lower body temperature measurement.



**WARNING** Patient injury risk. Do not exceed the recommended temperature measurement durations in Direct mode. Continuous measurement durations of 3 minutes at the oral and rectal sites and 5 minutes at the axillary site are recommended for accurate measurement. Do not continuously measure beyond 10 minutes in any mode.



**WARNING** Inaccurate measurement risk. To ensure optimal accuracy, always confirm that the correct mode and site are selected.



**WARNING** Patient injury risk. Prior to taking a temperature, instruct the patient not to bite down on the probe as patient injury and damage to the probe may result.



**CAUTION** Probe covers are disposable, nonsterilized, and single-use. Probes are also nonsterilized. Do not autoclave probes and probe covers. Ensure that probe covers are disposed of according to facility requirements or local regulations.

1. Remove the temperature probe from the probe well.  
The monitor sounds a tone as it enters the ready state.
2. Insert the probe into a new probe cover and press the probe handle down firmly.
3. Touch the **Temperature site control**  to choose from these measurement sites: oral, pediatric axillary, or adult axillary.

The temperature frame changes to Direct mode approximately 60 seconds after the probe is removed from the probe well.

The monitor sounds a tone to indicate the start of a Direct mode measurement.

4. Hold the probe tip in place at the oral or rectal measurement site for a total of 3 minutes and for 5 minutes at the axillary site.
5. While the measurements are taking place, the temperature frame displays the patient's continuous temperature measurements.



**Note** The monitor does not retain Direct mode temperatures in memory. Therefore, it is important to note the temperature before removing the probe from the measurement site and then manually record it in the patient record.

6. Remove the probe after the temperature measurement is complete and firmly press the eject button on the top of the probe to release the probe cover.
7. Return the probe to the probe well to continue taking temperatures in the Predictive mode.
8. Wash your hands to reduce the risk of cross-contamination.

## Take a temperature at the rectal site



**WARNING** Patient injury risk. When taking rectal temperatures, insert the probe tip only 5/8 inch (approximately 1.5 cm) inside the rectum of adults and only 3/8 inch (approximately 1 cm) inside the rectum of children to avoid the risk of bowel perforation.



**WARNING** Cross-contamination or nosocomial infection risk. Thorough hand-washing greatly reduces the risk of cross-contamination and nosocomial infection.



**WARNING** Patient injury risk. Do not exceed the recommended temperature measurement durations in Direct mode. Continuous measurement durations of 3 minutes at the oral and rectal sites and 5 minutes at the axillary site are recommended for accurate measurement. Do not continuously measure beyond 10 minutes in any mode.



**WARNING** Inaccurate measurement risk. To ensure optimal accuracy, always confirm that the correct mode and site are selected.



**CAUTION** Probe covers are disposable, nonsterilized, and single-use. Probes are also nonsterilized. Do not autoclave probes and probe covers. Ensure that probe covers are disposed of according to facility requirements or local regulations.

1. Remove the rectal temperature probe from the rectal probe well.

The monitor sounds a tone as it enters the ready state. The Temperature Site Control defaults to the rectal site.



2. Insert the rectal probe into a new probe cover and press the probe handle down firmly.
3. Separate the patient's buttocks with one hand. Use the other hand to gently insert the probe tip only 5/8 inch (1.5 cm) inside the rectum of adults and only 3/8 inch (approximately 1 cm) inside the rectum of children. The use of a lubricant is optional.
4. Insert the probe so that the tip is in contact with tissue. Continue to separate the buttocks and hold the probe in place throughout the measurement process. While the measurement is taking place, the temperature frame displays the process indicator.



5. The monitor sounds a tone when the final temperature is reached (in approximately 10 to 13 seconds). The temperature frame continues to display the temperature even after the probe is returned to the probe well.



**Note** To switch to the Direct mode, touch  after the Predictive mode measurement is acquired. The temperature frame displays text indicating that the Direct mode is active. The monitor sounds a tone to indicate the start of a Direct measurement. Once you are in the Direct mode, continue to separate the buttocks and hold the probe in place throughout the measurement process.

**Note** The monitor does not retain Direct mode temperatures in memory. Therefore, it is important to note the temperature before removing the probe from the measurement site and then manually record it in the patient record.

6. Remove the probe after the temperature measurement is complete and firmly press the eject button on the top of the probe to release the probe cover.
7. Return the probe to the probe well.
8. Wash your hands to reduce the risk of cross-contamination.

## Braun ThermoScan® PRO 4000 thermometer and accessory dock

The thermometer and accessory dock enable you to transfer an ear temperature measurement to the monitor. The dock also charges the thermometer battery.

Read the thermometer manufacturer's directions for use before attempting to configure, use, troubleshoot, or maintain the thermometer.



**WARNING** Liquids can damage electronics inside the thermometer. Prevent liquids from spilling on the thermometer. If liquids are spilled on the thermometer, dry off the thermometer with a clean cloth. Check for proper operation and accuracy. If liquids possibly entered the thermometer, remove the thermometer from use until it has been properly dried, inspected, and tested by qualified service personnel.



**CAUTION** Probe covers are disposable, nonsterilized, and single-use. The thermometer is also nonsterilized. Do not autoclave the thermometer and probe covers. Ensure that probe covers are disposed of according to facility requirements or local regulations.



**CAUTION** The thermometer has no user-serviceable parts. If service is required, call your nearest Welch Allyn Customer Service or Technical Support facility.



**CAUTION** Store the thermometer and probe covers in a dry location, free from dust and contamination and away from direct sunlight. Keep the ambient temperature at the storage location fairly constant and within the range of 50°F to 104°F (10°C to 40°C).

### Take a temperature at the ear site



**WARNING** Probe covers are single-use only. Re-use of a probe cover may result in spread of bacteria and cross-contamination.



**WARNING** Inaccurate measurement risk. Use only Braun ThermoScan probe covers with this thermometer.



**WARNING** Inaccurate measurement risk. Frequently inspect the probe window and keep it clean, dry, and undamaged. Fingerprints, cerumen, dust, and other contaminants reduce the transparency of the window and result in lower temperature measurements. To protect the window, always keep the thermometer in the accessory dock when the thermometer is not in use.



**CAUTION** Inaccurate measurement risk. Before taking a temperature measurement, make sure that the ear is free from obstructions and excess cerumen build-up.



**CAUTION** Inaccurate measurement risk. The following factors can affect ear temperature measurements for up to 20 minutes:

- The patient was lying on his or her ear.
- The patient's ear was covered.
- The patient was exposed to very hot or very cold temperatures.
- The patient was swimming or bathing.
- The patient was wearing a hearing aid or an ear plug.



**CAUTION** Inaccurate measurement risk. If ear drops or other ear medications have been placed in one ear canal, take the temperature in the untreated ear.

**Note** A temperature measurement taken in the right ear might differ from a measurement taken in the left ear. Therefore, always take the temperature in the same ear.

**Note** When the monitor receives an ear temperature measurement, it displays the measurement on the Home tab. If the Home tab already contains a temperature measurement, the new measurement overwrites it.

To take a measurement and transfer it to the monitor:

1. Make sure that the monitor is powered on.
2. Remove the ear thermometer from the accessory dock.
3. Locate the probe cover box in the accessory dock.
4. Firmly push the probe tip into the probe cover box.

When the probe cover is in place, the thermometer turns on automatically.

5. Wait for the ready beep and three dashes to appear on the thermometer display.
6. Fit the probe snugly into the ear canal and then push and release the **Start** button.
  - If the probe is positioned correctly in the ear canal the ExacTemp light flashes. When the thermometer detects an accurate measurement, the ExacTemp light is continuously on, a long beep signals the end of the measurement, and the display shows the result.
  - If the probe is positioned incorrectly in the ear canal or is moved during the measuring process, the ExacTemp light goes out, a sequence of short beeps sounds, and the error message POS (position error) appears.
7. When you are finished taking the temperature, press the ejector button to eject the used probe cover.

8. Return the thermometer to the accessory dock.

The LED on the dock flashes while the measurement is being transferred.

After the transfer is complete, the temperature and the temperature scale appear on the Home tab according to the monitor settings.

**Note** Only the latest measurement is transferred to the monitor.

**Note** Measurements that have already been transferred to the monitor cannot be transferred again.

For more information about thermometer functionality, refer to the thermometer manufacturer's directions for use.

## Change the temperature scale on the ear thermometer

To switch from Celsius to Fahrenheit, refer to the thermometer manufacturer's directions for use.

## Charge the ear thermometer battery

To charge the battery pack:

- Place the thermometer in the accessory dock.
- Make sure that the monitor is connected to AC power.
- Make sure that the monitor is powered on.

The LED on the dock indicates the charging status of the battery pack:

- Orange: The battery pack is charging.
- Green: The battery pack is charged.
- Not illuminated: The battery pack is not charging.

**Note** The battery pack continues to charge while the monitor is in Display power saving mode.

**Note** It is strongly recommended that you use only the Welch Allyn rechargeable battery pack in the thermometer because the dock cannot charge other batteries.

# SpO2

SpO2 and pulse rate monitoring continuously measures saturation level of oxygen in hemoglobin as well as the pulse rate in a patient through a pulse oximeter.

## SpO2 frame

The SpO2 frame displays data and controls used in pulse oximetry measurements.

The frame provides a numeric view and a waveform view of SpO2 data. You can toggle between views by touching the left side of the frame.

## SpO2 numeric view

The numeric view indicates the SpO2 saturation percentage and the pulse amplitude. Features of this view differ based on the type of sensor enabled and the profile selected.



The size of the SpO2 frame and displayed measurements varies based on your configuration.

**Nellcor sensor**

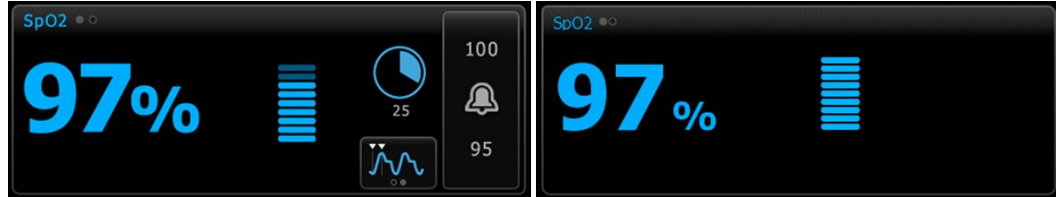

Intervals Monitoring and Continuous Monitoring profiles

Spot Check and Triage profiles

**Masimo sensor**



Intervals Monitoring profile, no SpHb license

Spot Check and Triage profiles

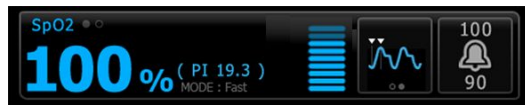

Intervals Monitoring profile, SpHb license activated

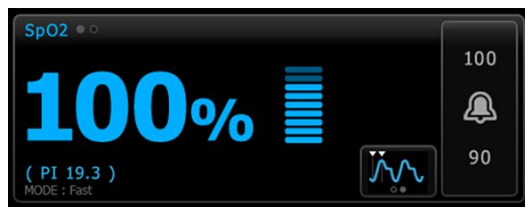

Continuous Monitoring profile

**Pulse amplitude**

The pulse amplitude bar indicates the pulse beat and shows the relative pulse strength. More bars illuminate as the detected pulse gets stronger.



## Response Mode Control

The Response Mode Control allows you to set the SpO2 measurement time to either Normal or Fast.



## Perfusion Index

Perfusion Index (PI) is an SpO2 feature available only with Masimo-equipped monitors.

PI is a relative reading of pulse strength at the monitoring site. PI display ranges from 0.1 percent (very weak pulse strength) to 20.0 percent (very strong pulse strength). PI is a relative number and varies between monitoring sites and from patient to patient, as physiological conditions vary.

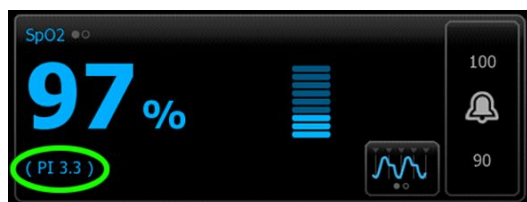

During sensor placement, the PI can be used to evaluate the appropriateness of an application site, looking for the site with the highest PI number. Placing the sensor at the site with the strongest pulse amplitude (highest PI number) improves performance during motion. Monitor the trend of the PI for changes in physiological conditions.

## SatSeconds™ alarm management

The SatSeconds feature is an SpO2 alarm management system available only with monitors that are equipped with Nellcor OxiMax Technology.

The SatSeconds feature is the product of the time and magnitude that a patient falls outside of the SpO2 alarm limits. For example, three points below the alarm limit for 10 seconds equals 30 SatSeconds. An alarm is triggered only when a desaturation event reaches the SatSeconds limit. The SatSeconds feature is clinician controlled and can be set to 0, 10, 25, 50, or 100 SatSeconds. If a desaturation event resolves on its own within the preset time, the clock will automatically reset and the monitor will not alarm.



### Note

The SatSeconds feature has a built-in safety protocol that sounds an alarm whenever three SpO2 violations of any amount or duration occur within a 1-minute period.

## SpO2 waveform view

The waveform view shows the real-time SpO2 plethysmograph waveform. You can select the waveform sweep speed in Advanced settings.

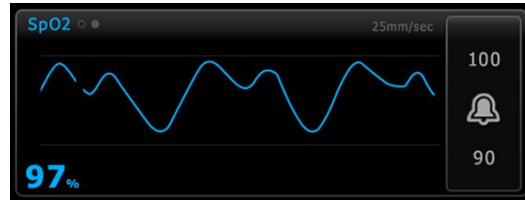

## Set up SpO2

Follow these steps to configure SpO2 parameter settings.

1. Touch the **Settings** tab.
2. Touch the **Setup** tab.
3. Touch the **SpO2** vertical tab.
4. Select the desired SpO2 measurement site using the list box.
5. Select the desired O2 flow rate and O2 concentration using the keypad.
6. Select the desired Sweep speed.
7. Scroll down and select the desired O2 Method from the list box.
8. Touch the **Home** tab.

The new settings take effect immediately.

## Configure SpO2 alarms

Follow these steps to set alarm limits for SpO2 measurements.

1. Verify that you are using the Intervals Monitoring or Continuous Monitoring profile.
2. Touch the **Alarms** tab.
3. Touch the **SpO2** vertical tab.
4. Ensure that the SpO2 alarm limit control is set to ON.

**Note** If any parameter's alarm limit control is set to OFF, you cannot adjust alarm limits on the Alarm tab, and no visual or audio signals will occur for that specific parameter.

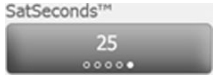
5. Enter the desired upper and lower alarms limits for SpO2 using the up/down arrow keys or the keypad.
6. If your monitor is configured with a Nellcor SpO2 sensor, touch  to select a SatSeconds setting.
7. Touch the **Home** tab.

The new alarm settings take effect immediately.

## Set Response Mode

To set the Response Mode from the Home tab, the monitor must be in the Intervals Monitoring or Continuous Monitoring profile.



Touch  in the SpO2 frame.

The SpO2 frame displays **MODE: Fast** when Fast mode is selected.

## Measure SpO2 and pulse rate



**WARNING** Inaccurate measurement risk. Use only Masimo rainbow SET sensors and accessories on Masimo-equipped monitors.



**WARNING** Inaccurate measurement risk. Use only Nellcor sensors and accessories on Nellcor-equipped monitors.



**WARNING** High-intensity lights (including pulsating strobe lights) directed on the pulse co-oximeter can prevent it from obtaining readings.



**WARNING** The pulsations from intra-aortic balloon support can increase the pulse rate displayed on the monitor. Verify the patient's pulse rate against the ECG heart rate.



**WARNING** Inaccurate measurement risk. Venous congestion might cause a low reading of arterial oxygen saturation. Place the sensor on a hand at heart level to ensure proper venous outflow from a monitored site.



**WARNING** Inaccurate measurement risk. The pulse co-oximeter can be used during defibrillation, but the reading may be inaccurate for up to 20 seconds.



**WARNING** Patient injury risk. Do not attempt to reprocess, recondition, or modify any sensors or patient cables. Doing so might damage electrical components.



**WARNING** Pulse rate measurement might not detect certain arrhythmias because it is based on the optical detection of a peripheral flow pulse. Do not use the pulse oximeter as a replacement or substitute for ECG-based arrhythmia analysis.



**WARNING** Use the pulse co-oximeter as an early warning device. As you observe a trend toward patient hypoxemia, use laboratory instruments to analyze blood samples to better understand the patient's condition.



**WARNING** The accuracy of SpO<sub>2</sub> measurements can be affected by any of the following:

- elevated levels of total bilirubin
- elevated levels of Methemoglobin (MetHb)
- elevated levels of Carboxyhemoglobin (COHb)
- hemoglobin synthesis disorders
- low perfusion at the monitored site
- the presence of concentrations of some intravascular dyes, sufficient to change the patient's usual arterial pigmentation
- patient movement
- patient conditions such as shivering and smoke inhalation
- motion artifact
- painted nails
- poor oxygen perfusion
- hypotension or hypertension
- severe vasoconstriction
- shock or cardiac arrest
- venous pulsations or sudden and significant changes in pulse rate
- proximity to an MRI environment
- moisture in the sensor
- excessive ambient light, especially fluorescent
- the use of the wrong sensor
- a sensor misapplied or dislodged
- severe anemia
- venous congestion

1. Verify that the sensor cable is connected to the monitor.



**WARNING** Patient injury risk. The sensor and extension cable are intended only for connection to pulse co-oximetry equipment. Do not attempt to connect these cables to a PC or any similar device. Always follow the sensor manufacturer's directions for care and use of the sensor.

2. Clean the application site. Remove anything, such as nail polish, that could interfere with sensor operation.

**Note** Do not use disposable sensors on patients who have allergic reactions to the adhesive.

3. Attach the sensor to the patient according to the manufacturer's directions for use, observing all warnings and cautions.



**WARNING** Patient injury and inaccurate measurement risk. Do not use tape to secure the sensor to the patient. This can restrict blood flow, damage the patient's skin, cause inaccurate readings, and damage the sensor.



**WARNING** Patient injury risk. Exercise caution when applying a sensor to a patient with compromised skin integrity. Applying tape or pressure to compromised sites can reduce circulation and cause additional skin damage.

**Note** If a sterile sensor is required, select a sensor that has been validated for sterilization, and follow the sensor manufacturer's directions for sterilizing the sensor.

Place the sensor and the NIBP cuff on different limbs to reduce unnecessary alarms when you monitor these parameters at the same time.

**Note** A range of sensors is available for different patient sizes and measurement sites. Consult the sensor manufacturer's instructions for selecting the correct sensor.

4. Confirm that the monitor displays SpO2 and pulse rate data within 15 seconds of connection to the patient.



**WARNING** Patient injury risk. Incorrect sensor application or excessive duration of sensor use can cause tissue damage. Inspect the sensor site periodically as directed in the sensor manufacturer's instructions.

While SpO2 is being measured, the displayed pulse rate is derived from the sensor. If SpO2 is not available, the pulse rate is derived from NIBP.

In the Intervals and Continuous profiles, detaching the sensor during a measurement triggers an alarm.

If SpO2 is being measured continuously on a patient for an extended period, change the sensor location at least every three hours or as indicated by the sensor manufacturer's instructions.

## SpHb

Monitors configured with Masimo total hemoglobin can measure hemoglobin (SpHb), SpO2, and pulse rate. SpHb monitoring continuously measures blood constituents and anemic status in a patient through a noninvasive SpHb pulse co-oximeter.

### SpHb frame

The SpHb frame displays data and controls used in total hemoglobin measurements.

**Note** SpHb is available only in the Intervals Monitoring and Continuous Monitoring profiles.

In this frame, one of two labels appears:

- **SpHbv** indicates the venous calibrated reference for total hemoglobin measurement.
- **SpHb** indicates the arterial calibrated reference for total hemoglobin measurement.

You can specify the reference source in Advanced settings.

The frame provides a numeric view and a graphical trend view of total hemoglobin data. You can toggle between views by touching the left side of the frame.

## SpHb numeric view

The numeric view indicates the total hemoglobin level in either grams per deciliter (g/dL) or millimoles per liter (mmol/L). You can select the unit of measure in Advanced settings. The size of the SpHb frame and displayed measurements varies based on your configuration.



## Averaging

The averaging button enables you to select the moving window of time used by the parameter to calculate the SpHb value and update the display: short (approximately 1 minute), medium (approximately 3 minutes), or long (approximately 6 minutes).



## SpHb graphical trend view

The graphical trend view presents a trend of the real-time measurements over a user-selected period. In Advanced settings, you can select the period displayed. The size of the SpHb frame and displayed trend varies based on your configuration.

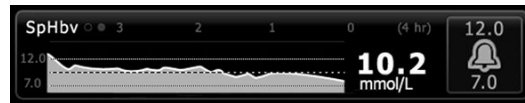

The graph shows total hemoglobin level on the y-axis and time on the x-axis (oldest measurements on the left to newest measurements on the right). The entire graph updates every 10 seconds.

To the right of the graph, the frame displays the current measurement in numeric format.

## Set up SpHb

Follow these steps to configure SpHb parameter settings.

1. Touch the **Settings** tab.
2. Touch the **Setup** tab.
3. Touch the **SpHb** vertical tab.
4. Select the desired Trend period.
5. Touch the **Home** tab.

The new settings take effect immediately.

## Configure SpHb alarms

Follow these steps to set alarm limits for SpHb measurements.

1. Verify that you are using the Intervals Monitoring or Continuous Monitoring profile.
2. Touch the **Alarms** tab.

3. Touch the **SpHb** vertical tab.
4. Ensure that the SpHb alarm limit control is set to ON.

**Note** If any parameter's alarm limit control is set to OFF, you cannot adjust alarm limits on the Alarm tab, and no visual or audio signals will occur for that specific parameter.

5. Enter the desired upper and lower alarm limits for SpHb using the up/down arrow keys or the keypad.
6. Touch the **Home** tab.

The new alarm settings take effect immediately.

## Set SpHb averaging mode



Touch  in the SpHb frame.

The SpHb frame displays the current mode.

## Measure SpHb



**WARNING** Inaccurate measurement risk. Use only Masimo rainbow SET sensors and accessories on Masimo-equipped monitors.



**WARNING** High-intensity lights (including pulsating strobe lights) directed on the pulse co-oximeter can prevent it from obtaining readings.



**WARNING** The pulsations from intra-aortic balloon support can increase the pulse rate displayed on the monitor. Verify the patient's pulse rate against the ECG heart rate.



**WARNING** Inaccurate measurement risk. Venous congestion might cause a low reading of arterial oxygen saturation. Place the sensor on a hand at heart level to ensure proper venous outflow from a monitored site.



**WARNING** Inaccurate measurement risk. The pulse co-oximeter can be used during defibrillation, but the reading may be inaccurate for up to 20 seconds.



**WARNING** Patient injury risk. Do not attempt to reprocess, recondition, or modify any sensors or patient cables. Doing so might damage electrical components.



**WARNING** Pulse rate measurement might not detect certain arrhythmias because it is based on the optical detection of a peripheral flow pulse. Do not use the pulse oximeter as a replacement or substitute for ECG-based arrhythmia analysis.



**WARNING** Use the pulse co-oximeter as an early warning device. As you observe a trend toward patient hypoxemia, use laboratory instruments to analyze blood samples to better understand the patient's condition.





**WARNING** The accuracy of SpHb measurements can be affected by any of the following:

- elevated levels of total bilirubin
- elevated levels of Methemoglobin (MetHb)
- elevated levels of Carboxyhemoglobin (COHb)
- hemoglobin synthesis disorders
- low perfusion at the monitored site
- the presence of concentrations of some intravascular dyes, sufficient to change the patient's usual arterial pigmentation
- patient movement
- patient conditions such as shivering and smoke inhalation
- motion artifact
- painted nails
- poor oxygen perfusion
- hypotension or hypertension
- severe vasoconstriction
- shock or cardiac arrest
- venous pulsations or sudden and significant changes in pulse rate
- proximity to an MRI environment
- moisture in the sensor
- excessive ambient light, especially fluorescent
- the use of the wrong sensor
- a sensor misapplied or dislodged
- severe anemia
- venous congestion

1. Verify that the sensor cable is connected to the monitor.



**WARNING** Patient injury risk. The sensor and extension cable are intended only for connection to pulse co-oximetry equipment. Do not attempt to connect these cables to a PC or any similar device. Always follow the sensor manufacturer's directions for care and use of the sensor.

2. Verify that you are using the Continuous or Intervals profile.
3. Clean the application site. Remove anything, such as nail polish, that could interfere with sensor operation.

**Note** Do not use disposable sensors on patients who have allergic reactions to the adhesive.

4. Attach the sensor to the patient according to the manufacturer's directions for use, observing all warnings and cautions.



**WARNING** Patient injury and inaccurate measurement risk. Do not use tape to secure the sensor to the patient. This can restrict blood flow, damage the patient's skin, cause inaccurate readings, and damage the sensor.



**WARNING** Patient injury risk. Exercise caution when applying a sensor to a patient with compromised skin integrity. Applying tape or pressure to compromised sites can reduce circulation and cause additional skin damage.

**Note** If a sterile sensor is required, select a sensor that has been validated for sterilization, and follow the sensor manufacturer's directions for sterilizing the sensor.

Place the sensor and the NIBP cuff on different limbs to reduce unnecessary alarms when you monitor these parameters at the same time.

**Note** A range of sensors is available for different patient sizes and measurement sites. Consult the sensor manufacturer's instructions for selecting the correct sensor.

5. Confirm that the monitor displays SpHb or SpHbv data after connection to the patient.



**WARNING** Patient injury risk. Incorrect sensor application or excessive duration of sensor use can cause tissue damage. Inspect the sensor site periodically as directed in the sensor manufacturer's instructions.

While SpHb is being measured, the displayed SpO2 and pulse rate are derived from the same sensor. If SpO2 is not available, the pulse rate is derived from NIBP.

Detaching the sensor during a measurement triggers an alarm.

If SpHb is being measured continuously on a patient for an extended period, change the sensor location at least every three hours or as indicated by the sensor manufacturer's instructions.

## Pulse rate frame

The Pulse rate frame displays data, information, and controls used in reading pulse rates.

Typically, the displayed pulse rate is derived from the SpO2 sensor. If SpO2 is not available, the pulse rate is derived from NIBP.



**WARNING** Inaccurate measurement risk. Pulse rate measurements generated through the blood pressure cuff or through SpO2 are subject to artifact and might not be as accurate as heart rate measurements generated through ECG or through manual palpation.

**Note** You can specify pulse tone volume in the Pulse rate vertical tab (located in the **Settings > Setup** tab).

## Continuous Monitoring profile



The size of the pulse rate frame and displayed measurements varies based on your configuration.

## Intervals Monitoring profile

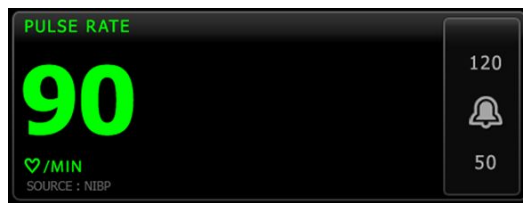

## Spot Check and Triage profiles



## Set up pulse rate

Follow these steps to configure pulse rate parameter settings.

1. Touch the **Settings** tab.
2. Touch the **Setup** tab.
3. Touch the **Pulse rate** vertical tab.
4. Select the desired Tone volume.
5. Touch the **Home** tab.

The new settings take effect immediately.

## Configure pulse rate alarms

Follow these steps to set alarm limits for pulse rate.

1. Verify that you are using the Intervals Monitoring or Continuous Monitoring profile.
2. Touch the **Alarms** tab.
3. Touch the **Pulse rate** vertical tab.
4. Ensure that the Pulse rate alarm limit control is set to ON.

**Note** If any parameter's alarm limit control is set to OFF, you cannot adjust alarm limits on the Alarm tab, and no visual or audio signals will occur for that specific parameter.

5. Enter the desired upper and lower alarm limits for pulse rate using the up/down arrow keys or the keypad.
6. Touch the **Home** tab.

The new alarm settings take effect immediately.

## Manual parameters frame

The Manual parameters frame, located in the lower right of the Home tab, supports manual entry of parameters and displays measurements taken by some accessories.

**Note** Manual parameters are not available in the Triage profile.

**Note** Body mass index (BMI) is only available with an attached weight scale that calculates BMI.

**Note** When a measurement is transferred from an attached weight scale to the monitor, the measurement displayed on the monitor is within one decimal place (0.1) of the measurement displayed by the weight scale.

**Note** You cannot manually enter temperature on a monitor configured with a SureTemp Plus temperature module.

**Note** You cannot manually enter respiration rate on a monitor configured with CO2 or RRa.

## Enter manual parameters

**Note** The Manual parameters frame enables you to enter measurements taken manually and displays measurements taken by some accessories. You can select and configure the parameters in Advanced settings. Only four parameters appear in the Manual parameters frame.



**CAUTION** Weight scales attached to this monitor must be running on battery power (battery type is specified in the weight scale manufacturer's directions for use). Do not use the weight scale's external power supply.

1. From the Home tab, touch anywhere within the Manual parameters frame.



The Manual tab appears.

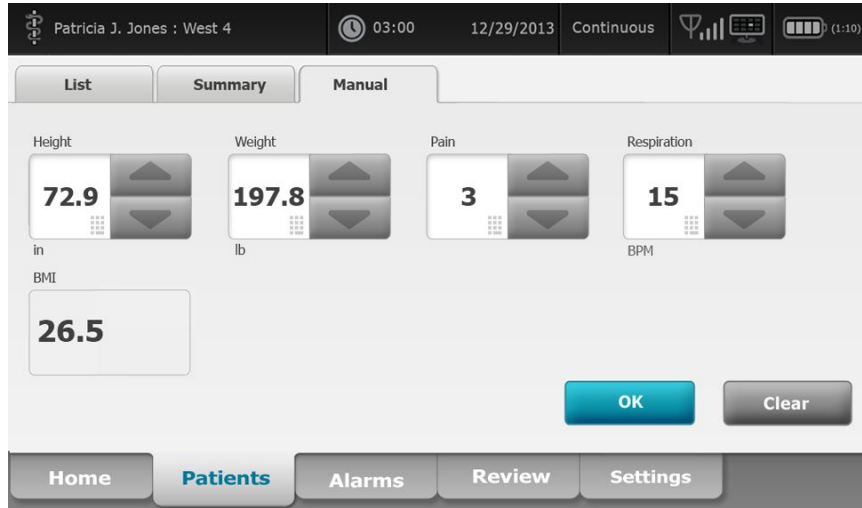

2. Touch the up/down arrow keys or the keypad to manually adjust height, weight, pain level, temperature, respiration rate, or other parameters.

**Note** If an approved, battery-powered weight scale is attached to the monitor, measurements from the weight scale populate fields in the Manual tab. You can adjust weight and height measurements on this tab, but if you do, the read-only BMI field will clear.

**Note** Ensure that the current patient ID is correct before saving.

3. Touch  to confirm settings and return to the Home tab.

**Note** In the Intervals Monitoring and Spot Check profiles, manual parameters clear from the Home tab after a successful save.



# Maintenance and service

---

## Perform periodic checks

Welch Allyn recommends that each facility conduct periodic checks of each monitor.

1. Check the following at least daily:
  - Audible indicators (a piezo beeper and a speaker tone) at power-up
  - Fan, especially at startup
  - Touchscreen alignment
  - Date
  - Time
2. Visually inspect the following at least weekly:
  - The monitor for any damage or contamination
  - The AC cord for exposed copper
  - All cables, cords, and connector ends for damage or contamination
  - All mechanical parts, including covers, for integrity
  - All safety-related labeling for legibility and adhesion to the monitor
  - All accessories (cuffs, tubing, probes, sensors) for wear or damage
  - Documentation for current revision of the monitor
3. Do the following at least monthly:
  - Test the speaker by selecting each alarm volume level and listening for the different tones
  - Visually inspect the mobile stand wheels for wear and faulty operation
  - Visually inspect the mounting screws on the wall or cart for looseness and wear

Update settings, replace items, or call for service as necessary based on results of visual inspection. Do not use the monitor if you see any signs of damage. Qualified service personnel must check any monitor that is damaged for proper operation before putting the monitor back into use.

## Replace the printer paper

The printer is located on the top of the monitor. Follow these steps to replace the roll of printer paper:

1. Grasp the two tabs and pull up to open the printer door.

2. Remove the empty core.



**WARNING** Hot surface. Do not touch the printer mechanism.

3. Insert a new roll of paper.

**Note** The paper roll must be installed so that it unwinds from the bottom of the roll, as illustrated. If the paper roll is not installed correctly, the printer will not print properly.

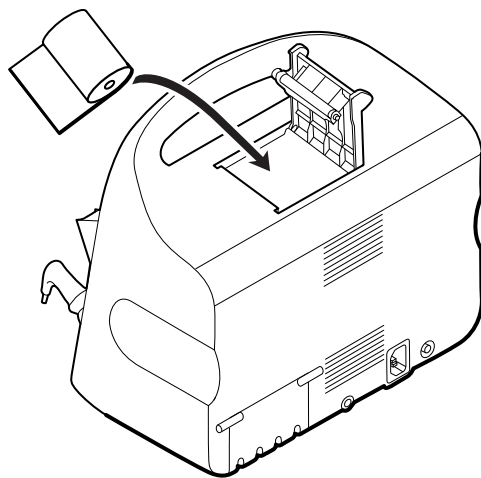

4. Advance the end of the roll past the roller so that it extends past the printer door, as shown.

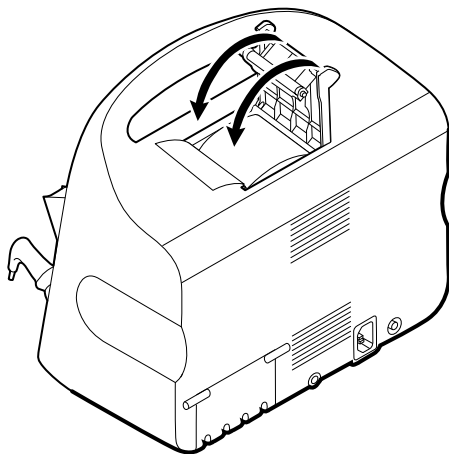

5. With one hand, pull lightly on the paper to take up any slack. With the other hand, close the printer door by pushing it down and into place until it clicks.

Be certain that the paper does not catch in the printer door.

## Change the battery

Before removing the battery, shut down the monitor.

1. Turn the monitor upside down to access the battery cover.



2. Locate the battery cover, indicated by .
3. Insert a coin into the slot and push to open. Choose a coin that fits comfortably in the slot.

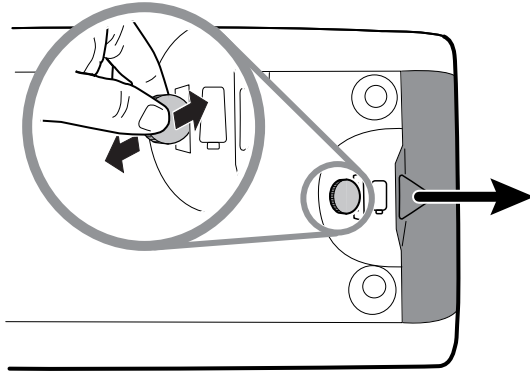

4. Pull the battery out by pulling the battery label, which is visible when you open the battery cover.

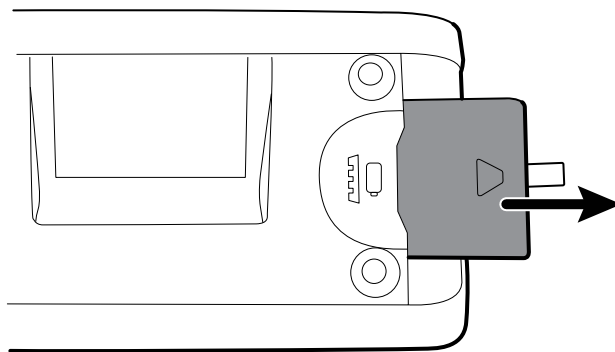

5. Slide in the new battery. Ensure that you insert the new battery in the same orientation as the old battery.

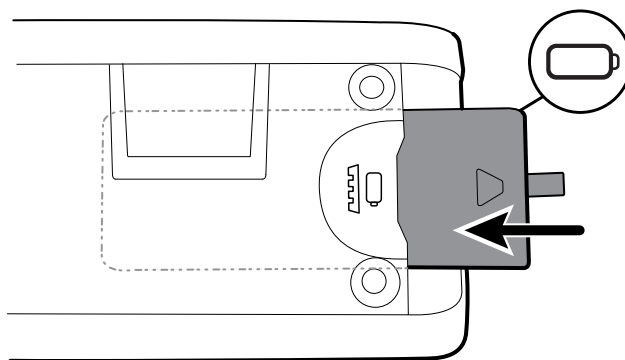

6. Replace the battery cover by positioning the end below  and then pressing firmly on the opposite end.

**Note** New batteries are only 30 percent charged. Therefore, connect the monitor to AC power immediately after inserting a new battery.



**WARNING** Risk of fire, explosion, and burns. Do not short-circuit, crush, incinerate, or disassemble the battery pack. Never dispose of batteries in refuse containers. Always recycle batteries according to local regulations.

## Clean the monitor



**WARNING** Electric shock hazard. Before cleaning the monitor, disconnect the AC power cord from the power outlet and the monitor.



**WARNING** Electric shock hazard. DO NOT autoclave the monitor or accessories. The monitor and the accessories are not heat-resistant.



**WARNING** Liquids can damage electronics inside the monitor. Prevent liquids from spilling on the monitor.

If liquids are spilled on the monitor:

1. Power down the monitor.
2. Disconnect the power plug.
3. Remove battery pack from the monitor.
4. Dry off excess liquid from the monitor.

**Note** If liquids possibly entered the monitor, remove the monitor from use until it has been properly dried, inspected, and tested by qualified service personnel.

5. Reinstall battery pack.
6. Power on the monitor and verify monitor functions normally before using it.

If liquids enter the printer housing:

1. Power down the monitor.
2. Disconnect the power plug.
3. Remove battery pack from the monitor.
4. Remove and discard the paper roll.
5. Clean and dry the inside of the printer housing.

**Note** The printer housing has a drain tube that directs liquids down and out the bottom of the device. If liquids possibly entered other openings in the monitor, remove the monitor from service until it has been properly dried, inspected, and tested by qualified service personnel.

6. Install a new roll of paper.
7. Power on the monitor and verify that the monitor functions normally before using it.

Clean on a routine basis according to your facility's protocols and standards or local regulations. If the monitor is on, lock the display and disconnect the AC power cord.

The following agents are compatible with the monitor:

- CaviWipes™
- Sani-Cloth® Plus
- 70 percent isopropyl alcohol
- 10 percent chlorine bleach solution

**Note** Disinfect according to your facility's protocols and standards or local regulations.

## CaviWipes or Sani-Cloth Plus

1. Using CaviWipes or Sani-Cloth Plus, wipe the surface of the monitor to remove all debris.
2. Allow the monitor surface to dry for a minimum of 10 minutes before using the monitor.

## 70 percent isopropyl alcohol

Wipe the monitor with a clean cloth slightly dampened with 70 percent isopropyl alcohol.

## 10 percent chlorine bleach solution

1. Wipe the monitor with a clean cloth slightly dampened with a 10 percent bleach and water solution. Follow the cleaning agent manufacturer's guidelines.
2. Rinse with a clean cloth slightly dampened with water that meets EP and USP quality standards.
3. Allow the monitor surface to dry for a minimum of 10 minutes before using the monitor.

## Clean the accessories

1. Wipe the NIBP hose and any reusable cuffs with a damp cloth moistened in a mild detergent solution.
2. Wipe the temperature probe with a cloth dampened with alcohol, warm water, or an appropriately diluted, nonstaining disinfectant solution.
3. Clean the pulse oximetry sensors with a cloth dampened with 70 percent isopropyl alcohol or 10 percent chlorine bleach solution.
4. Clean the RRA cable and the SpO<sub>2</sub>/RRA dual cable with a cloth dampened with 70 percent isopropyl alcohol.
5. Clean the ear thermometer according to the manufacturer's directions for use.
6. Clean the ear thermometer dock with the same cleaning agents used on the monitor.



**CAUTION** Never immerse any monitor accessories.

## Clean the stand

The same cleaning agents used on the monitor can be used on the stand and accessory cable management system. Clean on a routine basis according to your facility's protocols and standards, or local regulations.

**Note** Disinfect according to your facility's protocols and standards, or local regulations.



## Advanced settings

The Advanced tab provides password-protected access to the monitor's Advanced settings (or Admin mode), enabling nurse administrators, biomedical engineers, and/or service engineers to configure specific features. The Advanced tab also presents read-only information about the monitor.

**Note** You cannot enter the Advanced settings if sensors or physiological alarms are active or if vital sign measurements are displayed.

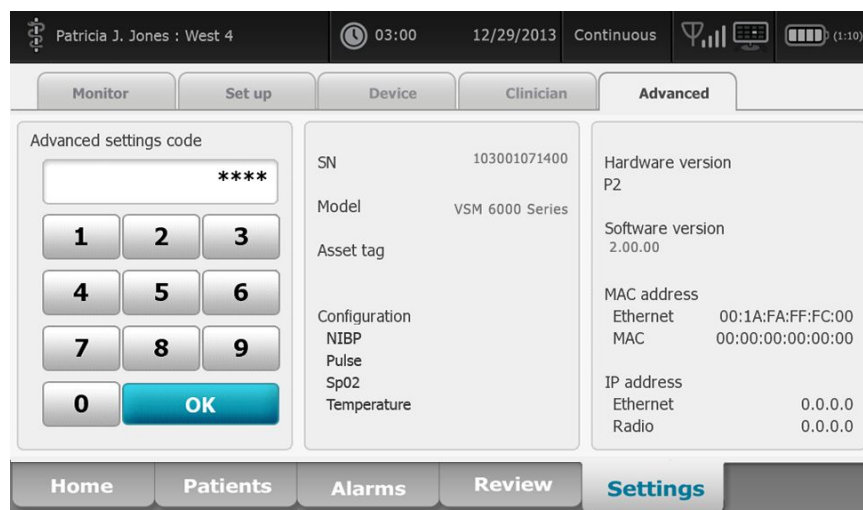

## General

### Specify the language

1. Access the Advanced Settings.
  - a. Touch the **Settings** tab.
  - b. Touch the **Advanced** tab.
  - c. Enter the **Advanced settings code**.
  - d. Touch **OK**.
 

The General tab appears, displaying the Language tab.
2. Select a language.
3. Do one of the following:
  - To continue in the Advanced Settings, touch another tab.

- To exit the Advanced Settings and return to the Home tab, touch **Exit**.

## Specify date and time settings

1. Access the Advanced Settings.
  - a. Touch the **Settings** tab.
  - b. Touch the **Advanced** tab.
  - c. Enter the **Advanced settings code**.
  - d. Touch **OK**.

The General tab appears.
2. On the General tab, touch the **Date / Time** tab.
3. Specify settings.

<b>Setting</b>	<b>Action/Description</b>
Date format	Select a date format for display.
Time zone	Select your time zone offset from Coordinated Universal Time (UTC).
Automatically adjust clock for daylight saving time, reported by host	Select this to adjust the displayed time by +/- one hour when the connected host reports daylight savings time.
Allow users to change date and time	Select this to allow clinicians to set the date and time from the Settings tab.
Display date and time	Select this to display the date and time on the Home tab in the Device Status area.

4. Do one of the following:
  - To continue in the Advanced Settings, touch another tab.
  - To exit the Advanced Settings and return to the Home tab, touch **Exit**.

## Specify advanced alarm settings

1. Access the Advanced Settings.
  - a. Touch the **Settings** tab.
  - b. Touch the **Advanced** tab.
  - c. Enter the **Advanced settings code**.
  - d. Touch **OK**.

The General tab appears.
2. Touch the **Alarms** tab.
3. Specify settings.

<b>Option</b>	<b>Description</b>
Allow user to disable alarms	Select to allow clinicians to turn off or turn on all alarm limits for each vital sign. The control is on each parameter-specific tab on the Alarms tab.
Allow user to turn off general audio	Select to allow clinicians to turn off all audio notification for alarms. This control is on the Alarms tab (on the General tab).
Minimum alarm volume	Select the minimum alarm volume available. If you select <b>High</b> , then <b>Medium</b> and <b>Low</b> are not available to the clinician.

	These controls are on the Alarms tab (on the General tab).
Audio pause time	Specify the amount of pause time that is added to the 60-second pause time. When a clinician pauses an audio alarm tone, the tone is paused for the combined amount of time.
Nurse call threshold	Select the minimum priority alarm that activates a nurse call relay. If you select <b>High</b> , only high-level alarms activate a nurse call relay.
SpO2 alarm condition delay	Specify the minimum amount of time that an SpO2 alarm condition must be active before audio and visual signals occur.  SatSeconds is available with Nellcor SpO2 sensors. If you select 0 seconds or 10 seconds, SatSeconds is disabled, and it is removed from the SpO2 tab in the Alarms tab.
SpHb alarm condition delay	Specify the minimum amount of time that an SpHb alarm condition must be active before audio and visual signals occur.
etCO2 alarm condition delay	Specify the minimum amount of time that an etCO2 alarm condition must be active before audio and visual signals occur.
Respiration alarm condition delay	Specify the minimum amount of time that an RR alarm condition must be active before audio and visual signals occur.
No breath detected alarm delay	If configured with a CO2 module, specify the amount of time for the device to wait after receiving a "valid breath" message before activating the "No breath detected" physiological alarm.  If configured for RRA, specify the time that the Masimo module will wait before sending a respiration pause event, which will result in a "No breath detected" physiological alarm.

4. Do one of the following:
  - To continue in the Advanced Settings, touch another tab.
  - To exit the Advanced Settings and return to the Home tab, touch **Exit**.

## Specify advanced display settings

1. Access the Advanced Settings.
  - a. Touch the **Settings** tab.
  - b. Touch the **Advanced** tab.
  - c. Enter the **Advanced settings code**.
  - d. Touch **OK**.

The General tab appears.

2. Touch the **Display** tab.
3. Specify settings.

### Setting

Display lock

### Action/Description

Specify the required period of clinician inactivity before the touchscreen locks.

Display power saver	Specify the required period of monitor inactivity before the display turns off.
Device power down	Specify the required period of monitor inactivity before the monitor turns off.

4. Do one of the following:
  - To continue in the Advanced Settings, touch another tab.
  - To exit the Advanced Settings and return to the Home tab, touch **Exit**.

## Specify advanced device settings

1. Access the Advanced Settings.
  - a. Touch the **Settings** tab.
  - b. Touch the **Advanced** tab.
  - c. Enter the **Advanced settings code**.
  - d. Touch **OK**.

The General tab appears.

2. Touch the **Device** tab.
3. Specify settings.

### Option

### Description

Location ID	Touch  and enter up to 20 alphanumeric characters.
Enable Save as default	Select to enable display of the Save as default control.
Standby Mode timeout	Specify the default timeout used when entering Standby Mode in the Continuous Monitoring profile.
Power line frequency	Specify power line frequency for AC power supplied to the device.
Available profiles	Specify the profiles to be available for selection.
Allow profile change	Select to enable selection of different profiles. When disabled, the current profile selection in the Settings tab is locked in. No other profile selection buttons are available.
Default profile	Specify the default profile to be used at startup in the following Continuous Monitoring profile workflows: 1) patient trend data has not been saved, and 2) patient trend data has been saved and the user selects a new patient.

4. Do one of the following:
  - To continue in the Advanced Settings, touch another tab.
  - To exit the Advanced Settings and return to the Home tab, touch **Exit**.

## Set and start the demo mode

1. Access the Advanced Settings.
  - a. Touch the **Settings** tab.



- b. Touch the **Advanced** tab.
- c. Enter the **Advanced settings code**.
- d. Touch **OK**.

The General tab appears.

2. Touch the **General** tab.
3. Touch the **Demo** tab.
4. Specify settings.

#### Setting

Type

Start

#### Action/Description

Select a type of demonstration mode.

Touch **Start** to put the monitor in demonstration mode. Navigate to the Home tab to begin Demo mode.

5. Do one of the following:
  - To continue in the Advanced Settings, touch another tab.
  - To exit the Demo mode, touch **Exit** on the Home tab. The monitor restarts automatically.

## Parameters

### Specify advanced IPI settings

1. Access the Advanced Settings.
  - a. Touch the **Settings** tab.
  - b. Touch the **Advanced** tab.
  - c. Enter the **Advanced settings code**.
  - d. Touch **OK**.

The General tab will appear.

2. Touch the **Parameters** tab.
3. Touch the **IPI** tab.
4. Specify settings.

#### Setting

Display IPI

Default view

Trend period default

#### Action/Description

Select to allow clinicians to turn off or turn on IPI on the Home tab.

Select a numeric view or trend graph view as the primary IPI display on the Home tab.

Select a default time period for the trend graph display of IPI.

5. Do one of the following:
  - To continue in the Advanced Settings, touch another tab.
  - To exit the Advanced Settings and return to the Home tab, touch **Exit**.

### Specify advanced RRa settings

1. Access the Advanced Settings.
  - a. Touch the **Settings** tab.

- b. Touch the **Advanced** tab.
- c. Enter the **Advanced settings code**.
- d. Touch **OK**.

The General tab appears.

2. Touch the **Parameters** tab.
3. Touch the **RRa** tab.
4. Specify settings.

#### Setting

RRa averaging

Freshness timeout

#### Action/Description

Select the default averaging option that provides the desired visibility of subtle variations in RRa measurements.

Select the period of time the device should wait before alarming while it attempts to obtain a valid RRa reading.

5. Do one of the following:
  - To continue in the Advanced Settings, touch another tab.
  - To exit the Advanced Settings and return to the Home tab, touch **Exit**.

## Specify advanced SpO2 settings

1. Access the Advanced Settings.
  - a. Touch the **Settings** tab.
  - b. Touch the **Advanced** tab.
  - c. Enter the **Advanced settings code**.
  - d. Touch **OK**.

The General tab appears.

2. Touch the **Parameters** tab.
3. Touch the **SpO2** tab.
4. Specify settings.

#### Setting

Default view

Default response

Sweep speed default

#### Action/Description

Select a numeric view or a waveform view as the default primary SpO2 display on the Home tab.

Select the default speed of response to changes in SpO2 measurements.

Select the default waveform sweep speed for the SpO2 display in the Home tab.

5. Do one of the following:
  - To continue in the Advanced Settings, touch another tab.
  - To exit the Advanced tabs and return to the Home tab, touch **Exit**.

## Specify advanced pulse rate settings

1. Access the Advanced Settings.
  - a. Touch the **Settings** tab.
  - b. Touch the **Advanced** tab.

- c. Enter the **Advanced settings code**.
- d. Touch **OK**.

The General tab appears.

2. Touch the **Parameters** tab.
3. Touch the **Pulse rate** tab.
4. Specify settings.

#### Setting

Display source

#### Action/Description

Select this to show the source of pulse rate measurements (NIBP or SpO2) on the Home tab.

5. Do one of the following:
  - To continue in the Advanced Settings, touch another tab.
  - To exit the Advanced Settings and return to the Home tab, touch **Exit**.

## Specify advanced etCO2 settings

1. Access the Advanced Settings.
  - a. Touch the **Settings** tab.
  - b. Touch the **Advanced** tab.
  - c. Enter the **Advanced settings code**.
  - d. Touch **OK**.

The General tab appears.

2. Touch the **Parameters** tab.
3. Touch the **etCO2** tab.
4. Specify settings.

#### Setting

Default view

Display FiCO2

Waveform scale default

Unit of measure

Check calibration

Calibrate

Sweep speed default

Enable sampling line dialog

BTPS compensation

Calibration due hours

Maintenance due hours

#### Action/Description

Select a numeric view or a waveform view as the primary etCO2 display on the Home tab.

Select to display FiCO2 on the Home tab.

Select the default waveform scale in etCO2 measurements.

Select primary units of measure for the etCO2 display on the Home tab.

Select to start CO2 calibration check.

Select to start CO2 calibration.

Select the default waveform sweep speed for the CO2 waveform view on the Home tab.

Select to enable the sampling line dialog to be displayed when connecting a sampling line to the device.

Select to enable automatic adjustments for BTPS (body temperature pressure saturated) to improve the accuracy of CO2 measurements.

Displays time remaining until CO2 sensor calibration is required.

Displays time remaining until CO2 periodic sensor maintenance is required.

Last calibration	Displays date (XX/XX/XXXX) and time (00:00:00) of last calibration.
Annual calibration	Displays anniversary date (XX/XX) of annual calibration.

- For more calibration information, see the Service manual.

- Do one of the following:
  - To continue in the Advanced Settings, touch another tab.
  - To exit the Advanced tabs and return to the Home tab, touch **Exit**.

## Specify advanced SpHb settings

- Access the Advanced Settings.
  - Touch the **Settings** tab.
  - Touch the **Advanced** tab.
  - Enter the **Advanced settings code**.
  - Touch **OK**.

The General tab appears.

- Touch the **Parameters** tab.
- Touch the **SpHb** tab.
- Specify settings.

### Setting

Default view

Unit of measure

Default averaging

Reference

### Action/Description

Select a numeric view or a waveform view as the primary SpHb display on the Home tab.

Select the primary unit of measure for the SpHb display on the Home tab.

Select the default moving window of time used by the parameter to calculate the SpHb value and update the display: short (approximately 1 minute), medium (approximately 3 minutes), or long (approximately 6 minutes).

Select arterial or venous as the calibrated reference source.

- Do one of the following:
  - To continue in the Advanced Settings, touch another tab.
  - To exit the Advanced tabs and return to the Home tab, touch **Exit**.

## Specify advanced NIBP settings

- Access the Advanced Settings.
  - Touch the **Settings** tab.
  - Touch the **Advanced** tab.
  - Enter the **Advanced settings code**.
  - Touch **OK**.

The General tab appears.

- Touch the **Parameters** tab.
- Touch the **NIBP** tab.

## 4. Specify settings.

**Setting**

Default view

Unit of measure

Tube type

Algorithm default

Cuff inflation target

Allow interval program changes

## 5. Do one of the following:

- To continue in the Advanced Settings, touch another tab.
- To exit the Advanced Settings and return to the Home tab, touch **Exit**.

**Action/Description**

Select primary and secondary views.

Select **Display MAP** to display mean arterial pressure (MAP) in the NIBP frame on the Home tab.If **Display MAP** is selected, specify which numerics are primary in the NIBP frame. On the Home tab, clinicians can touch the NIBP frame to toggle between views.

Select the NIBP unit of measure for display.

Select the number of tubes that are connected to the NIBP cuff that is used with this monitor. If you select **1 tube**, the only algorithm available for selection is **Step**.

Select the default algorithm used to determine NIBP measurements.

If you select the **Step** algorithm, touch  and enter a default cuff inflation target for each type of patient. In the Patients tab on the Summary tab, clinicians can change the CITs from the default CITs that you set here.

Select to enable user to modify interval program selections in the **Settings > Setup > Interval** tab.

## Specify advanced temperature settings

1. Access the Advanced Settings.
  - a. Touch the **Settings** tab.
  - b. Touch the **Advanced** tab.
  - c. Enter the **Advanced settings code**.
  - d. Touch **OK**.

The General tab will appear.

2. Touch the **Parameters** tab.
3. Touch the **Temperature** tab.
4. Specify settings.

**Setting**

Unit of measure

Display temperature conversion

Default SureTemp Plus site

**Action/Description**

Select primary units of measure for the temperature display on the Home tab

Select this to display primary units of measure and secondary units of measure for the temperature display on the Home tab.

Select the default site for SureTemp measurements. The default site applies when clinicians power up the monitor and each time clinicians remove the temperature probe from the well.

Select **Last Site** to set the default to the site selected for the last measurement.

5. Do one of the following:
  - To continue in the Advanced Settings, touch another tab.
  - To exit the Advanced Settings and return to the Home tab, touch **Exit**.

## Specify the manual parameters

The Manual Parameters frame is in the lower right corner of the Home tab. You can manually enter values for parameters in the frame. You also can specify which parameters appear in the frame.

1. Access the Advanced Settings.
  - a. Touch the **Settings** tab.
  - b. Touch the **Advanced** tab.
  - c. Enter the **Advanced settings code**.
  - d. Touch **OK**.

The General tab appears.

2. Touch the **Parameters** tab.
3. Touch the **Manual** tab.

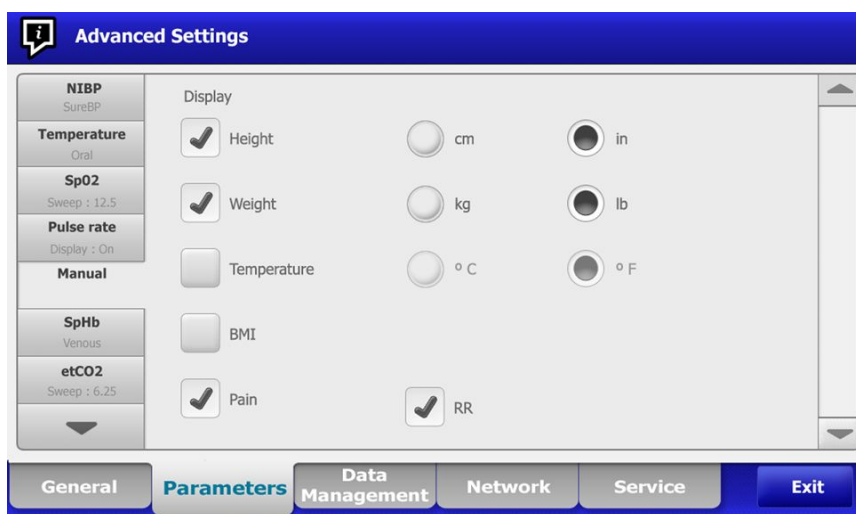

4. Select up to four parameters and associated units of measure for display in the Manual Parameters frame.

**Note** If the monitor has the SureTemp Plus temperature module, the Temperature parameter is not available here or in the Manual Parameters frame.

**Note** If the monitor is configured with CO2 or RRA, the respiration rate (RR) parameter is not available here or in the Manual Parameters frame.

5. Do one of the following:
  - To continue in the Advanced Settings, touch another tab.
  - To exit the Advanced Settings and return to the Home tab, touch **Exit**.

# Data management

## Specify patient settings

Patient identification appears on the Home tab in the Patient frame, and it is listed in various tabs, such as the Patient tab and the Review tab.

1. Access the Advanced Settings.
  - a. Touch the **Settings** tab.
  - b. Touch the **Advanced** tab.
  - c. Enter the **Advanced settings code**.
  - d. Touch **OK**.

The General tab appears.

2. Touch the **Data Management** tab.
3. Touch the **Patient** tab.
4. Specify settings.

### Setting

Default patient type

Name format

Primary label

Secondary label

Require patient ID to save readings

Search by patient ID

Clear patient information on manual save

Retrieve list

### Action/Description

Select a default patient type for this monitor. The patient type shows in the Patient frame on the Home tab.

In the Summary tab on the Patients tab, clinicians can change the displayed patient type from the default patient type that you set here.

Select a format for all displayed patient names: **Full name** or **Abbreviation**.

Select the primary identification label for all displayed patients.

Select a secondary identification label for patients. A secondary label displays only on the Home tab, after the primary label.

Make entering a patient ID a prerequisite for saving measurements. If they fail to enter an identifier, the monitor prompts them when they try to save.

Enable clinicians to enter a patient ID to query for the patient's information. If clinicians scan the ID onto the Home tab or the Summary tab, the monitor queries the patient list and the network. Returned patient information populates the Patient frame on the Home tab and fields on the Summary tab.

Specify that the monitor clears the selected patient after a clinician manually saves measurements from the Home tab. Patient information clears from the Patient frame and the Summary tab.

Note: This setting does not take effect when intervals are in progress.

Enable the monitor to retrieve the patient list from the network. When this option is selected, a **Retrieve list** button replaces the **Add** button on the List tab. Information from the network populates the List tab when clinicians touch the **Retrieve list** button. Since the **Add** button is not available, clinicians cannot add a patient to the patient list.

5. Do one of the following:
  - To continue in the Advanced Settings, touch another tab.
  - To exit the Advanced Settings and return to the Home tab, touch **Exit**.

## Specify clinician settings

Clinician identification appears next to the medicine symbol in the Device Status area on the Home tab.

1. Access the Advanced Settings.
  - a. Touch the **Settings** tab.
  - b. Touch the **Advanced** tab.
  - c. Enter the **Advanced settings code**.
  - d. Touch **OK**.

The General tab appears.

2. Touch the **Data Management** tab.
3. Touch the **Clinician** tab.
4. Specify settings.

### Setting

Label

### Action/Description

Select a type of clinician identification label for display on the Home tab: **Full name**, **Abbreviation**, **Clinician ID**, or **Symbol only**.

Require clinician ID to save readings

Make entering a clinician ID a prerequisite for saving measurements. If they fail to enter identification, the monitor prompts them when they try to save measurements. Clinicians can enter clinician identification on the Clinician tab.

Search by clinician ID

Enable the monitor to query the network for clinician information based on ID. The monitor initiates the search when the clinician enters or scans the ID from the Clinician tab. Returned clinician information populates the Device Status area and fields on the Clinician tab.

Clear clinician information on manual save

Select **Require password** to require clinicians to enter their password, in addition to ID, on the Clinician tab. The monitor uses the ID and password combination to query the network for clinician information.

Specify that the monitor clears the selected clinician after a clinician manually saves measurements from the Home tab. Clinician information clears from the Clinician tab and the Device Status area.

5. Do one of the following:
  - To continue in the Advanced Settings, touch another tab.
  - To exit the Advanced Settings and return to the Home tab, touch **Exit**.

## Specify clinical data settings

1. Access the Advanced Settings.
  - a. Touch the **Settings** tab.
  - b. Touch the **Advanced** tab.



- c. Enter the **Advanced settings code**.
- d. Touch **OK**.

The General tab appears.

2. Touch the **Data Management** tab.
3. Touch the **Clinical Data** tab.
4. Specify settings.

#### Setting

Automatically send on manual save

#### Action/Description

Select this option to specify that measurements are sent to the network when a clinician saves measurements on the Home tab.

**Note** When the monitor is not connected to the network, measurements saved on the monitor are sent to the network with the first successful send after reconnecting to the network.

Delete readings after successful send

Select this option to specify that measurements are deleted from the monitor after they are successfully sent to the network. Sent measurements do not appear in the Review tab.

Emulate Spot Vital Signs LXi

Select this option to specify that clinical data sent to the network appears as Spot Vital Signs LXi data at the network.

Connect to CS

Select to enable connection to the Connex central station.

5. Do one of the following:
  - To continue in Advanced Settings, touch another tab.
  - To exit the Advanced Settings and return to the Home tab, touch **Exit**.

## Network

### View advanced monitor information

The Status tab shows the monitor's software version, MAC and IP addresses, network, server and access point information, session information, and more.

1. Access the Advanced Settings.
  - a. Touch the **Settings** tab.
  - b. Touch the **Advanced** tab.
  - c. Enter the **Advanced settings code**.
  - d. Touch **OK**.

The General tab appears.
2. Touch the **Network** tab.
3. Touch the **Status** tab.
4. View the information.
5. Do one of the following:
  - To continue in the Advanced Settings, touch another tab.
  - To exit the Advanced Settings and return to the Home tab, touch **Exit**.

## Specify radio settings

This task is applicable only to monitors that have a radio installed.

1. Access the Advanced Settings.
  - a. Touch the **Settings** tab.
  - b. Touch the **Advanced** tab.
  - c. Enter the **Advanced settings code**.
  - d. Touch **OK**.

The General tab appears.

2. Touch the **Network** tab.
3. Touch the **Radio** tab.
4. Specify settings.

### Setting

Enable radio

### Action/Description

Enable the radio for device communications. When disabled, the radio is not available.

Enable radio network alarms

Activate radio network alarms when an alarm condition occurs. When disabled, radio network alarms are not available.

SSID

Touch  and enter the service set identifier (SSID). Enter a maximum of 16 characters.

Radio band

Select the radio band.

Authentication type

Select an authentication scheme. Then specify any additional settings that appear.

Method

Select a method. Then touch  and enter characters: **Network key** (64 characters), or **Password** (8 to 63 characters).

Security protocol

Select the security protocol.

EAP type

Select the EAP type.

Identity

Enter the EAP identity (maximum of 32 characters).

Password

Enter the EAP password (maximum of 32 characters).

Key number

Select the WEP key number.

Key

Enter the WEP key (10 characters for WEP 64, or 26 characters for WEP 128).

Configure radio

Touch **Configure radio** to activate all new radio settings not selected previously.

Touch **OK** in the confirmation popup telling you to power down the monitor.

Touch the **Settings** tab. Touch the **Device** tab. Touch **Power down**.

The radio will reboot.

**Note** If you do not touch **Configure radio**, none of the changed radio settings will take effect.

5. Do one of the following:
  - To continue in the Advanced Settings, touch another tab.



- To exit the Advanced Settings and return to the Home tab, touch **Exit**.

## Specify server settings

1. Access the Advanced Settings.
  - a. Touch the **Settings** tab.
  - b. Touch the **Advanced** tab.
  - c. Enter the **Advanced settings code**.
  - d. Touch **OK**.

The General tab appears.

2. Touch the **Network** tab.
3. Touch the **Server** tab.
4. Specify settings.

Setting	Action/Description
Obtain server IP information automatically	Enable the monitor to automatically obtain the server IP information via the network.
IP address	Touch  and enter the IP address of the server that is used for patient data communication. The range of entry for each field is 0 to 255.
Port	Touch  and enter the port number associated with the server IP address. The range of entry is 0 to 65535.
UDP broadcast port	Touch  and enter the port number that is used to automatically obtain server IP information. The range of entry is 0 to 65535.
Test	Touch <b>Test</b> to test the connection to the configured server.

5. Do one of the following:
  - To continue in the Advanced Settings, touch another tab.
  - To exit the Advanced Settings and return to the Home tab, touch **Exit**.

## Service

The Service tab presents numerous settings and controls typically accessed by authorized service or biomedical engineering personnel to configure, maintain, test, and update the device. For example, the Service tab enables authorized users to save device configurations to a USB flash drive and then load saved configurations to other devices. Systems and devices configured with the PartnerConnect™ service feature also have access to remote diagnostics, troubleshooting, and software upgrades.

For a description of service-related advanced settings, see the service manual for this product.



# Troubleshooting

---

This section presents tables of technical alarm and information messages, as well as problem descriptions that do not generate messages, to help you troubleshoot issues on the monitor.

**Note** Problem descriptions without messages appear at the end of this section.

When the monitor detects certain events, a message appears in the Device Status area at the top of the screen. Message types include the following:

- Information messages, which appear on a blue background.
- Very low-priority alarms, which appear on a cyan background.
- Low- and medium-priority alarms, which appear on an amber background.
- High-priority alarms, which appear on a red background.

Technical alarm messages are low priority unless noted in the Message column.

You can dismiss a message by touching the message on the screen, or, for some messages, you can wait for the message to time out.

To use these tables, locate the message that displays on the monitor in the left column of the table. The remainder of the row explains possible causes and suggests actions that can resolve the issue.

**Note** Instructions to "Call for service" in the following tables mean that you should contact qualified service personnel in your facility to investigate the issue.

## CO2 messages

Message	Possible cause	Suggested action
CO2 not functional. Call for service.	A nonrecoverable communications error has occurred	Call for service.
Filter line disconnected.	The sampling line is not connected to the monitor	Connect a sampling line to the monitor.  Check to ensure that the sampling line plug is tightly connected to the monitor.
Occlusion in gas line.	The purge cycle failed to clear a blockage in the sampling line	Replace the sampling line.

Message	Possible cause	Suggested action
CO2 temperature out of range. CO2 is not calibrated.	CO2 module temperature is out of range	Wait for the module temperature to return to normal and the module to reset before calibrating CO2.
		Move to a location where the ambient temperature enables the module temperature to return to normal and the module to reset before calibrating CO2.
Connect or clear filter line.	Calibration failed because sampling line is blocked or kinked	Check sampling line for obstruction or kinks. Replace the filter line if necessary.
	Module is not ready for calibration because the sampling line is not connected to the monitor	Check to ensure that the sampling line plug is tightly connected to the monitor.
Purging filter line.	An occlusion was detected in the sampling line, which automatically initiated a purge cycle	Wait for the purge cycle to clear the blockage and the module to be reset.
Check calibration gas concentration.	The calibration gas is not flowing	Check that the calibration gas is turned on.
	The calibration gas has the wrong CO2 concentration	Check that the calibration gas has the correct concentration.
Check calibration gas flow.	The calibration gas flow is unstable	Check the sampling line for kinks or obstructions.
		Check all tubing connections for leaks.
		Check that the gas source is not running out.
Check exhaust port for obstruction.	The exhaust port is blocked	Call for service.
	Internal flow problem	
Calibration overdue. CO2 might not be accurate.	The due date for calibration has passed	Perform CO2 calibration or call for service.
Factory service overdue. CO2 might not be accurate.	The due date for factory service has passed	Call for service.
Calibration failed. <i>Error message here.</i>	The calibration failed for the reason named in the error message	Check the error message and take corrective action presented.
Calibration completed successfully.	An uninterrupted, error-free calibration took place	Resume using the monitor.
Calibration aborted.	You or some other user interrupted the calibration	Resume or retry calibration.

## RRa messages

Message	Possible cause	Suggested action
Respiratory freshness timeout expired.	Excessive ambient or environmental noise	Reduce the level of noise in the room.
	Poor sensor placement on the patient	Remove the sensor from the patient and reapply.
	The patient cable or sensor is defective	Replace the patient cable or sensor.
Replace RRa probe.	The sensor is faulty	Replace the sensor.
	No sensor is connected	Connect the sensor.
	The cable is faulty	Replace the cable.
RRa patient interference detected.	Poor sensor placement on the patient	Remove the sensor from the patient and reapply.
	The patient is talking	Ask the patient to limit talking.
	The patient is snoring	Gently adjust the patient's position to reduce snoring. Awaken and ask the patient to adjust their position to reduce snoring.
RRa background interference detected.	Excessive ambient or environmental noise	Reduce the level of noise in the room.

## NIBP messages

Message	Possible cause	Suggested action
NIBP air leak; check cuff and tubing connections.	The NIBP module has an air leak	Check the cuff, tubing, and connections for leaks. If no leaks are found, clear the alarm and retry NIBP.  If the message reappears, call for service to replace the NIBP module.
NIBP not functional. Call for service.	A module error occurred	Call for service.
	The ambient temperature is out of range	Use the monitor in the specified temperature range.
Unable to determine NIBP; check connections; limit patient movement.	The NIBP module detected a motion artifact	Check connections; limit patient movement. Clear the alarm and retry NIBP.

Message	Possible cause	Suggested action
Unable to determine NIBP; check connections and tubing for kinks.	The NIBP tubing on the outside of the device has a kink	Check the connections and tubing for kinks. Clear the alarm and retry NIBP.
	The NIBP module needs to be calibrated	Call for service to calibrate the NIBP module.
	Tubing inside the NIBP module is kinked	Call for service to replace the NIBP module.
Incorrect NIBP cuff size; check patient type.	The cuff size is not correct for the selected patient type	Check the patient type and cuff size. Clear the alarm and retry NIBP.
Inflation too quick; check NIBP cuff and tubing connections.	NIBP inflation was too quick	Check the connections and tubing for kinks. Clear the alarm and retry NIBP.
Unable to determine NIBP; check inflation settings.	Target pressure is too low	Check inflation settings and change as necessary. Clear the alarm and retry NIBP.
		Change the cuff inflation target (CIT).
Excessive patient movement.	The NIBP module detected a motion artifact	Touch <b>OK</b> to dismiss. Limit patient movement and retry NIBP.
Tube type does not match device configuration. (NIBP measurement is available)	The tube connected to the NIBP sensor does not match the monitor's configuration	Touch <b>OK</b> to dismiss. Use the tube type specified for the monitor.
Tube type does not match device configuration. (NIBP measurement is not available)	User is using a single-lumen tube with the following Advanced settings: 1. Patient type is Pediatric or Adult 2. Tube type is 2 3. Algorithm is SureBP	Clear message. Modify settings or tube use to match patient type.

## SpO2 and SpHb messages

Message	Possible cause	Suggested action
SpO2 not functional. Call for service.	A module error has occurred	Try a new cable/sensor pair. Call for service.
Searching for pulse signal. (High-priority alarm)	The SpO2 sensor is not attached to the patient's finger	Touch the alarm icon or the SpO2 frame to dismiss the alarm.  Set SpO2 alarm limits to OFF.



Message	Possible cause	Suggested action
		Reattach the SpO2 sensor to the patient's finger.
Attach SpO2 sensor to monitor.	The sensor was not detected	Check the sensor connection. Replace the SpO2 sensor.
Replace the SpO2 sensor.	The SpO2 sensor is faulty or expired	Replace the SpO2 sensor.
	No SpO2 sensor is connected	Connect an SpO2 sensor.
	The cable is faulty or expired	Replace the cable.
Replace the SpO2 cable.	The cable is faulty or expired	Replace the cable.
Low SpO2 signal quality. Check sensor.	Poor sensor placement on the patient	Remove the sensor from the patient and reapply.
Low SpHb signal quality. Check sensor.	The patient cable or sensor is defective	Call service to test or replace the module.
Low perfusion. Check sensor.	The SpO2 module is faulty	Remove the sensor from the patient and reapply.
SpO2 mode only. Check sensor or cable.	The sensor is operating as an SpO2-only sensor because it failed to calibrate properly	Reattach the cable to the monitor. Remove the sensor from the patient and reapply.
SpO2 sensor expires in.... <b>Note</b> This message only appears on devices configured with SpHb.	The SpO2 sensor will expire soon	Replace the SpO2 sensor.

## Temperature messages

Message	Possible cause	Suggested action
Connect temperature probe.	No probe is connected	Connect a temperature probe and retry.
	The probe is faulty	Replace the temperature probe.
	The temperature module returned a connect probe message	Connect a temperature probe and retry. If a probe is already connected, replace the probe.
Insert correct color-coded probe well.	The probe well is missing	Insert a temperature probe well.
Replace temperature probe.	The probe is faulty	Replace the temperature probe.
Temperature not functional. Call for service.	A module error occurred	Call for service.

Message	Possible cause	Suggested action
Temperature time limit exceeded. Retry temperature measurement.	The direct mode timed out	Remove the probe from the measurement site.
Tissue contact lost.	The probe has lost contact with the patient's tissue	Touch <b>OK</b> to dismiss the message. Return the probe to the probe well and retry patient temperature measurement. Ensure that the probe makes proper contact with the patient's tissue.
Retry temperature measurement.	A probe heater or data error occurred	Retry the temperature measurement. If the problem persists, replace the probe.
<b>Note</b> This message often accompanies other temperature messages.	User settings require adjustment	Adjust the user settings and retry.
	The ambient temperature is out of range	Operate the monitor within the specified temperature range. Retry patient temperature measurement.
	The SureTemp temperature module is faulty	Call for service.

## Weight scale messages

Message	Possible cause	Suggested action
Weight scale not functional. Call for service.	The weight scale is not operating properly.	Call for service.

## Patient data management messages

Message	Possible cause	Suggested action
Maximum number of patient records saved. Oldest record overwritten.	The maximum number of patient records in the monitor's memory has been exceeded	On the Review tab, delete old records to prevent the alarm from appearing when new records are saved.
No data saved.	No patient data is available	Take or enter vital signs before saving.
Patient ID required to save data.	The configuration requires a patient ID to save data	Call for service to modify advanced settings.
Clinician ID required to save data.	The configuration requires a clinician ID to save data	Call for service to modify advanced settings.
Patient ID required to send data.	The configuration requires a patient ID to send data	Add a patient ID.

Message	Possible cause	Suggested action
Patient list is full. Delete some patients to add more.	The maximum number of patients was exceeded	Delete a patient from the list to add a new patient.
Stop intervals to select new patient.	The monitor is set to take interval readings	Stop intervals before changing the patient.
No connection for send.	No connectivity is available to support sending data manually or automatically sending data on manual save	Call for service to check the network connection or wireless settings.
Unable to retrieve list.	The monitor is unable to retrieve a patient list from the network	Call for service to check the network connection or wireless settings, or to verify that the server is available.
Unable to identify clinician.	The clinician ID or password is incorrect	Confirm the clinician ID and password (if applicable), and retry.

## Communications module messages

Message	Possible cause	Suggested action
Communications module did not power on properly. Power down the device. (High-priority alarm)	Communication failure	Call for service.

## Radio messages

Message	Possible cause	Suggested action
Radio not functional. Call for service.	A hardware failure occurred The radio has the wrong software	Call for service to update the radio software or replace the radio.
Radio error. Power down and restart.	The monitor and the radio failed to establish communication with each other	Power down and restart. If problem persists, call for service.
Unable to establish network communications. Radio out of network range.	The radio is no longer communicating with the access point	Call for service to verify that the device is within the radio coverage area and is configured to the network.
Unable to establish network communications. Call for service.	Unable to get an IP address from the DHCP server	Call for service to verify that the server is available.

## Ethernet messages

Message	Possible cause	Suggested action
Network not found; check network cable connection.	A network cable is unplugged	Check the network cable connection. If problem persists, call for service.
	A network connection is broken elsewhere	

## USB messages

Message	Possible cause	Suggested action
USB Communication failure. Call for service.	An internal or external device is connected but failed enumeration	Power down and restart.
		Check USB connections.
		If problem persists, call for service.
External device not licensed for use.	A license for an external device (e.g., barcode scanner) has not been activated	Disconnect the unlicensed device.
		Call for service to obtain the authorization code from Welch Allyn to activate the license.
External device not recognized.	An unrecognized external device is connected	Disconnect the unrecognized device.
Incompatible Welch Allyn device.	A communication protocol failure has occurred	Call for service.
USB accessory disconnected.	The USB cable between an external device and the monitor is disconnected	Confirm that the USB cable is connected to the device and the monitor.

## System messages

Message	Possible cause	Suggested action
Set date and time.	The date or time is not set	Set the date and time.
	The date or time is not set properly	Reset the date or time.
Device shutdown is not available at this time.	Device cannot perform an immediate shutdown	Touch <b>OK</b> , wait, and retry.
Advanced settings unavailable.	Sensors are taking measurements	Stop continuous measurements.
	A physiological alarm condition is active	Respond to or reset the alarm.
	Spot Check measurements have not been saved	Save the measurements.
Unexpected restart occurred. Call for service.	A system error caused the monitor to restart.	Call for service.

## Battery power manager messages

Message	Possible cause	Suggested action
Low battery 5 minutes or less remaining. (High-priority alarm)	Battery power is extremely low	Connect the monitor to AC power. (If not connected to AC power, the monitor powers down when battery power is depleted.)
Low battery 30 minutes or less remaining.	Battery power is low	Touch the alarm icon to dismiss or connect the monitor to AC power.
Battery is absent or faulty.	There is no battery in the monitor	Insert a battery.
Battery is absent or faulty. Call for service.	The battery is faulty	Replace the battery.
Device is operating in battery mode.	The AC power cord has been disconnected	Touch <b>OK</b> to dismiss or connect the monitor to AC power.

## Configuration Manager messages

Message	Possible cause	Suggested action
Unable to load configuration; using factory defaults.	A configuration load error occurred	Call for service.
Functional error. Call for service.	A critical configuration load error occurred	Call for service.
No connection for send.	The monitor is not configured to the network	Call for service.

## Printer messages

Message	Possible cause	Suggested action
Low battery, unable to print; plug into outlet.	The monitor's battery voltage is too low to support printing	Connect the monitor to AC power.
Printer door is open; close to continue.	The printer door is open	Close the printer door.
Out of paper.	The paper is not properly loaded	Align the paper with the print head. If the problem persists, call for service.
	The paper sensor does not detect paper	Replace the paper. If the problem persists, call for service.
Printer too hot; wait to retry.	The print head overheated	Wait for the print head to cool down and retry. If the problem persists, call for service.
External device not recognized.	An external printer is plugged into a USB port	Unplug the external printer.

Message	Possible cause	Suggested action
Printer not functional. Call for service.	The printer motor is broken	Call for service.
	The detection switch malfunctioned	
	A hardware failure occurred in the power supply	
	The printer does not identify itself correctly	
	The printer does not enumerate	
Printing records: <b>Note</b> The number of records requested appears in the message and counts down during printing.	The monitor is printing the records selected on the Review tab	Acknowledge the number of records printing or touch <b>Cancel</b> to interrupt printing.
Printing report; please wait.	The printer needs more time to complete a print job when the <b>Automatic print on interval</b> control has been enabled	Wait for the print job to print completely.  Disable <b>Automatic print on interval</b> in Intervals settings.

## Network messages

Message	Possible cause	Suggested action
Lost connectivity with host.	The central station or other host application has stopped running or is not operating properly	Confirm that the host application is running properly.

## Problems and solutions

The problems addressed in this table do not generate alarm or information messages on the monitor.

Problem	Possible cause	Suggested action
No SpHb value is displayed	An SpO2-only cable is connected to the monitor	Replace the SpO2-only cable with an SpO2/SpHb (Masimo rainbow) cable.
	The SpO2/SpHb reusable sensor has expired	Replace the sensor.
	<b>Note</b> A technical alarm appears.	
	Poor sensor placement on the patient	Remove the sensor from the patient and reapply.
	The monitor may have the SpHb license, but the SpO2 module does not	Contact Welch Allyn to verify that the SpO2 module contains the SpHb license.

<b>Problem</b>	<b>Possible cause</b>	<b>Suggested action</b>
No weight measurement is transferred from the scale to the monitor	The scale is not connected	Inspect the USB cables from the device to the adapter to the scale to ensure that they are connected properly.
	The scale setting is incorrect	Ensure that the scale settings are enabled for transfer.





# Specifications

## Physical specifications

### Protection classifications, all monitor configurations

Characteristic	Specification
Electrical rating	100 – 240 V AC, 50 – 60 Hz, 0.8 – 1.5 A
Duty cycle	Continuous operation
Type of protection against electric shock	Class I equipment (protectively earthed) with double insulation
Degree of protection against electric shock, for parts applied to patients	Type BF defibrillator proof IEC EN 60601-1, 2nd Edition
Recovery time following defibrillator discharge	Less than or equal to 10 seconds
Flammable anesthetics	 <b>WARNING</b> Not suitable for use with flammable anesthetics.
Degree of protection provided by the enclosure with respect to harmful ingress of liquids	IPX0 Non-protected according to EN/IEC 60529; Pulse oximeter equipment complies with ISO 9919 Cl. 44.6 Ingress of liquids tests and EN/IEC 60601-1, 60601-2-30, 60601-2-49 Cl. 44.3 Spillage tests
Height	Standard chassis: 10 in. (25.4 cm) Extended chassis: 10 in. (25.4 cm)
Width	Standard chassis: 11 in. (27.9 cm) Extended chassis: 11.38 in. (28.9 cm)
Depth	Standard chassis: 6 in. (15.3 cm) Extended chassis: 7.5 in. (19.1 cm)
Weight (including battery)	Standard chassis: 9.5 lb (4.3 kg) Extended chassis: 10.4 lb (4.7 kg)

---

**Protection classifications, all monitor configurations**

---

**Graphical display resolution**

---

Display area	8 in. (H) x 4 in. (V) (19.5 [H] cm x 11.3 [V] cm)
--------------	---

---

Pixels	1024 (H) x 600 (V)
--------	--------------------

---

Pixel arrangement	RGB (red, green, blue)
-------------------	------------------------

---

Color depth	16 bits per pixel
-------------	-------------------

---

**Speaker volume**

---

Output sound pressure	67 dB at 1.0 meter
-----------------------	--------------------

---

<b>Alarm and pulse tones</b>	per IEC 60601-1-8
------------------------------	-------------------

---

Pulse frequency ( $f_0$ )	150 – 1000 Hz
---------------------------	---------------

---

Number of harmonic components in the range 300 Hz to 4000 Hz	minimum of 4
--	--------------

---

Effective pulse duration ( $t_d$ )	high priority: 75 – 200 ms medium and low priority: 125 – 250 ms
------------------------------------	---

---

Rise time ( $t_r$ )	10 – 20% of $t_d$
---------------------	-------------------

---

Fall time <sup>a</sup> ( $t_f$ )	$t_f \leq t_s - t_r$
----------------------------------	----------------------

---

**Note** The relative sound pressure level of the harmonic components should be within 15 dB above or below the amplitude at the pulse frequency.

---

<sup>a</sup>Prevents overlap of pulses.

---

<b>Battery specifications</b>	<b>6 cell</b>	<b>9 cell</b>
Rating	11.1 V 3.80Ah (42Wh)	10.8 V 6.75Ah (73Wh)
Composition	Lithium-ion	Lithium-ion
Charge time to 80 percent capacity	2hr 7m	2hr 25m
Charge time to 100 percent capacity	3hr	4hr
Patient exams per charge <sup>1</sup>	26	47
Age to 70 percent capacity <sup>2</sup>	300	300
Operating time per charge for continuous monitoring <sup>3,4</sup>	Do not use	2hr (only if clinician remains in the room)

---

<b>Battery specifications</b>	<b>6 cell</b>	<b>9 cell</b>
<p><sup>1</sup>A patient exam includes NIBP, Temperature, and SpO2 measurements at the rate of one patient every 10 minutes with a 2-minute display time out setting and a new battery.</p>		
<p><sup>2</sup>After this many full charge and discharge cycles, the battery has aged to where its total capacity has been reduced to 70 percent of its rating.</p>		
<p><sup>3</sup> This specification is based on a monitor with the following characteristics:</p> <ul style="list-style-type: none"> <li>• A new, fully charged 9-cell battery</li> <li>• CO2, SpO2, SpHb and the radio operating continuously</li> <li>• One blood pressure measurement every 10 minutes</li> <li>• One printout every 10 minutes</li> </ul> <p>As batteries age, their capacity diminishes. Replace the battery when a noticeable decrease in operating time is observed or when total capacity is below 70% (as described in Note 2 above).</p>		
<p><sup>4</sup> If battery power supplied to the monitor falls below the specified lower limit, the monitor powers down. There is no impact on monitor performance or accuracy as the battery charge runs down. A high-priority alarm occurs when a charge of 5 minutes or less remains on the battery. Plugging the monitor into a power outlet starts recharging the battery immediately and prevents the monitor from powering down.</p>		
<b>Ethernet connection specifications</b>		
Ethernet	Communicates using 10base-T and 100-base T	
<b>Nurse Call connection specifications</b>		
Nurse Call	25 V AC or 60 V DC maximum at 1A maximum	
<b>NIBP specifications</b>		
Units of measure	Systolic, diastolic, MAP: mmHg, kPa; user-selectable Pulse rate: beats per minute	
Cuff pressure range	Meets or exceeds ANSI/AAMI SP10:2002 standards for cuff pressure range	
Systolic range	Adult: 30 to 260 mmHg (4.0 to 34.7 kPa) (StepBP, SureBP) Pediatric: 30 to 260 mmHg (4.0 to 34.7 kPa) (StepBP, SureBP) Neonate: 20 to 120 mmHg (2.7 to 16.0 kPa) (StepBP)	
Diastolic range	Adult: 20 to 220 mmHg (2.7 to 29.3 kPa) (StepBP, SureBP) Pediatric: 20 to 220 mmHg (2.7 to 29.3 kPa) (StepBP, SureBP) Neonate: 10 to 110 mmHg (1.3 to 14.7 kPa) (StepBP)	
Cuff Inflation Target	Adult: 160 mmHg (21.3 kPa) (StepBP) Pediatric: 120 mmHg (16.0 kPa) (StepBP) Neonate: 90 mmHg (12.0 kPa) (StepBP)	
Maximum Target Pressure	Adult: 280 mmHg (37.3 kPa) (StepBP, SureBP)	

**NIBP specifications**

	Pediatric: 280 mmHg (37.3 kPa) (StepBP, SureBP) Neonate: 130 mmHg (17.3 kPa) (StepBP)
Blood pressure determination time	Typical: 15 seconds Maximum: 150 seconds
Blood pressure accuracy	Meets or exceeds ANSI/AAMI SP10:2002 standards for noninvasive blood pressure accuracy, $\pm 5$ mmHg (0.7 kPa) mean error, 8 mmHg (1.1 kPa) standard deviation
Mean Arterial Pressure (MAP) range The formula used to calculate MAP yields an approximate value.	Adult: 23 to 230 mmHg (3.1 to 30.7 kPa) (StepBP, SureBP) Pediatric: 23 to 230 mmHg (3.1 to 30.7 kPa) (StepBP, SureBP) Neonate: 13 to 110 mmHg (1.7 to 14.7 kPa) (StepBP)
Pulse rate range (using blood pressure determination)	Adult: 30 to 200 beats per minute (StepBP, SureBP) Pediatric: 30 to 200 beats per minute (StepBP, SureBP) Neonate: 35 to 220 beats per minute (StepBP)
Pulse rate accuracy (using blood pressure determination)	$\pm 5.0\%$ ( $\pm 3$ beats per minute)
Overpressure cutoff	Adult: 300 mmHg $\pm 15$ mmHg (40.0 kPa $\pm 2.0$ kPa) Pediatric: 300 mmHg $\pm 15$ mmHg (40.0 kPa $\pm 2.0$ kPa) Neonate: 150 mmHg (20.0 kPa) maximum

**SureTemp Plus temperature module specifications**

Units of measure	$^{\circ}\text{F}$ , $^{\circ}\text{C}$ ; user-selectable
Temperature range	80 $^{\circ}\text{F}$ to 110 $^{\circ}\text{F}$ (26.7 $^{\circ}\text{C}$ to 43.3 $^{\circ}\text{C}$ )
Calibration accuracy	$\pm 0.2^{\circ}\text{F}$ ( $\pm 0.1^{\circ}\text{C}$ ) (Direct mode)

**Braun ThermoScan PRO 4000 thermometer specifications (refer to manufacturer's directions for use for additional information)**

Units of measure	$^{\circ}\text{F}$ , $^{\circ}\text{C}$ ; user-selectable
Temperature range	68 $^{\circ}\text{F}$ to 108 $^{\circ}\text{F}$ (20 $^{\circ}\text{C}$ to 42.2 $^{\circ}\text{C}$ )
Calibration accuracy	<ul style="list-style-type: none"> <li><math>\pm 0.4^{\circ}\text{F}</math> (<math>\pm 0.2^{\circ}\text{C}</math>) for temperatures ranging from 95.9<math>^{\circ}\text{F}</math> to 107.6<math>^{\circ}\text{F}</math> (35.5<math>^{\circ}\text{C}</math> to 42<math>^{\circ}\text{C}</math>)</li> <li><math>\pm 0.5^{\circ}\text{F}</math> (<math>\pm 0.3^{\circ}\text{C}</math>) for temperatures outside of this range</li> </ul>
Display resolution	0.1 $^{\circ}\text{F}$ or $^{\circ}\text{C}$

**Nellcor specifications (for additional information, refer to the directions for use that accompanies each accessory)**

**SpO2**

Unit of measure	%
Measurement range	1% to 100%

Nellcor sensor accuracy guide

SpO2 measurement accuracy can only be evaluated in vivo by comparing pulse oximeter readings with SaO2 measurements obtained from simultaneously sampled arterial blood made using a laboratory CO-oximeter. SpO2 accuracy was validated through breathe-down-equivalent testing by Covidien using electronic measurements to prove equivalence to the Nellcor N600x predicate device. The Nellcor N600x predicate device was validated by performing human-subject, “breathe-down” clinical trials.

Accuracy

**Note** Saturation accuracy varies by sensor type. The worst case accuracy range of the module or the attached sensor will apply.

Saturation accuracy (module)

±3 digits  
 70% to 100%  
 Adult, Pediatrics: ± 2 digits  
 Neonate: ± 3 digits  
 Low Perfusion: 0.02 % to 20 % ± 2 digits

Saturation accuracy (sensors)	Sensor	Accuracy
60% to 80%	MAX-AI, MAX-PI, MAX-II	±3 digits
70% to 100%	DS-100A	±3 digits
	D-YS	Infants, Pediatrics, Adults: ±3 digits Neonates: ±4 digits
	D-YSE	±4 digits
	D-YSPD	±4 digits
	MAX-AI, MAX-PI, MAX-II	±2 digits
	OXI-A/N	Adults: ±3 digits Neonates: ±4 digits
	OXI-P/I	±3 digits

**Pulse rate**

Unit of measure	beats per minute
-----------------	------------------

---

**Nellcor specifications (for additional information, refer to the directions for use that accompanies each accessory)**

---

Measurement range	20 to 250 beats per minute
-------------------	----------------------------

Accuracy	±3 digits
----------	-----------

Functional tester	
-------------------	--



**WARNING** Functional testers cannot be used to assess the accuracy of a pulse oximeter monitor.<sup>1</sup>

---

<sup>1</sup> Some models of commercially available bench-top functional testers and patient simulators can be used to verify the proper functionality of Nellcor pulse oximeter sensors, cables and monitors. See the individual testing device's operator's manual for the procedures specific to the model of tester being used.

While such devices may be useful for verifying that the pulse oximeter sensor, cabling, and monitor are functional, they are incapable of providing the data required to properly evaluate the accuracy of a system's SpO<sub>2</sub> measurements. Fully evaluating the accuracy of the SpO<sub>2</sub> measurements requires, at a minimum, accommodating the wavelength characteristics of the sensor and reproducing the complex optical interaction of the sensor and the patient's tissue. These capabilities are beyond the scope of known bench-top testers. SpO<sub>2</sub> measurement accuracy can only be evaluated in vivo by comparing pulse oximeter readings with SaO<sub>2</sub> measurements obtained from simultaneously sampled arterial blood made using a laboratory CO-oximeter.

Many functional testers and patient simulators have been designed to interface with the pulse oximeter's expected calibration curves and may be suitable for use with Nellcor monitors and/or sensors. Not all such devices, however, are adapted for use with the Nellcor OXIMAX digital calibration system. While this will not affect use of the simulator for verifying system functionality, displayed SpO<sub>2</sub> measurement values may differ from the setting of the test device. For a properly functioning monitor, this difference will be reproducible over time and from monitor to monitor within the performance specifications of the test device.

---

**Masimo specifications (for additional information, refer to the directions for use that accompanies each accessory)**

---

**SpO<sub>2</sub>**

Unit of measure	%
-----------------	---

Measurement range	0% to 100%
-------------------	------------

Masimo SpO <sub>2</sub> sensor accuracy guide	Accuracy specified when used with Masimo SET pulse oximetry monitors or with licensed Masimo SET pulse oximetry modules using PC series patient cables, during no motion. Numbers present ±1 standard deviation. Plus or minus one standard deviation represents 68% of the population.
---	---

Accuracy <sup>1</sup>	
-----------------------	--

**Note**

Saturation accuracy varies by sensor type. For additional sensor accuracy information, refer to the DFU that accompanies the sensor.

70% to 100%	
-------------	--

Adults, Infants, Pediatrics (no motion<sup>2</sup>): ±2%

Neonates (no motion<sup>2</sup>): ±3%

Adults, Infants, Pediatrics, Neonates (motion<sup>3</sup>): ±3%

---

---

**Masimo specifications (for additional information, refer to the directions for use that accompanies each accessory)**

---

Adults, Infants, Pediatrics, Neonates (low perfusion<sup>4</sup>):  $\pm 2\%$

Resolution 1%

---

**Perfusion Index**

---

Measurement range 0.1% to 20.0%

---

**Pulse rate**

---

Unit of measure beats per minute

---

Measurement range 25 to 240 beats per minute

---

Accuracy<sup>5</sup> Adults, Infants, Pediatrics, Neonates (no motion):  $\pm 3$  beats per minute  
 Adults, Infants, Pediatrics, Neonates (motion):  $\pm 5$  beats per minute  
 Adults, Infants, Pediatrics, Neonates (low perfusion<sup>4</sup>):  $\pm 3$  beats per minute

---

Resolution 1 beat per minute

---

**SpHb**

---

Units of measure g/dL, mmol/L; user-selectable

---

Measurement range 0.0 to 25.0 g/dL (0.0 to 15.5 mmol/L)

---

Accuracy<sup>6</sup> Adults, Pediatrics (no motion): 8 to 17 g/dL  $\pm 1$  g/dL

---

Resolution 0.1 g/dL or mmol/L

---

**RRa**

---

Unit of measure breaths per minute

---

Body weight Adult >66 pounds (30 kilograms)

---

Measurement range 0 to 70 breaths per minute

---

Accuracy<sup>7</sup> Adults: 4 to 70  $\pm 1$  breath per minute

---

Resolution 1 breath per minute

---

<sup>1</sup> SpO<sub>2</sub> accuracy was determined by testing on healthy adult volunteers in the range of 60% to 100% SpO<sub>2</sub> against a laboratory CO-Oximeter. SpO<sub>2</sub> accuracy was determined on 16 neonatal NICU patients ranging in age from 7 to 135 days old and weighing between 0.5 and 4.25 kg. Seventy-nine (79) data samples were collected over a range of 70% to 100% SaO<sub>2</sub> with a resultant accuracy of 2.9% SpO<sub>2</sub>. Contact Masimo for testing specifications.

<sup>2</sup> The Masimo sensors have been validated for no-motion accuracy in human blood studies on healthy adult male and female volunteers with light to dark skin pigmentation in induced hypoxia studies in the range of 70% to 100% SpO<sub>2</sub>

---

---

**Masimo specifications (for additional information, refer to the directions for use that accompanies each accessory)**

---

against a laboratory CO-Oximeter and ECG monitor. This variation equals  $\pm 1$  standard deviation which encompasses 68% of the population.

<sup>3</sup> The Masimo sensors have been validated for motion accuracy in human blood studies on healthy adult male and female volunteers with light to dark skin pigmentation in induced hypoxia studies while performing rubbing and tapping motions, at 2 to 4 Hz at an amplitude of 1 to 2 cm and a non-repetitive motion between 1 to 5 Hz at an amplitude of 2 to 3 cm in induced hypoxia studies in the range of 70% to 100% SpO<sub>2</sub> against a laboratory CO-Oximeter and ECG monitor. This variation equals  $\pm 1$  standard deviation which encompasses 68% of the population.

<sup>4</sup> The Masimo rainbow SET CO-Oximeter module has been validated for low-perfusion accuracy in bench-top testing against a Fluke Biotek Index 2 simulator and Masimo's simulator with signal strengths of greater than 0.02% and transmission of greater than 5% for saturations and pulse rates within the stated accuracy specifications. This variation equals  $\pm 1$  standard deviation which encompasses 68% of the population.

<sup>5</sup> The Masimo sensors have been validated for pulse rate accuracy for the range of 25 to 240 beats per minute in bench-top testing against a Biotek Index 2 simulator. This variation equals  $\pm 1$  standard deviation which encompasses 68% of the population.

<sup>6</sup> SpHb accuracy has been validated on healthy adult male and female volunteers and on surgical patients with light to dark skin pigmentation in the range of 8 g/dL to 17 g/dL SpHb against a laboratory CO-Oximeter. The variation equals  $\pm 1$  standard deviation which encompasses 68% of the population. The SpHb accuracy has not been validated with motion or low perfusion.

<sup>7</sup> Respiration rate accuracy for the RRa sensor and instrument has been validated for the range of 4 to 70 breaths per minute in bench-top testing. Clinical validation for up to 30 breaths per minute was also performed with the RRa sensor and instrument.

---

**CO<sub>2</sub> specifications (for additional information, refer to the directions for use that accompanies each accessory)**

---

CO <sub>2</sub> accuracy <sup>1, 2, 3</sup>	0 to 38 mmHg: $\pm 2$ mmHg 39 to 150 mmHg: $\pm(5\%$ of reading + 0.08% for every 1 mmHg above 38 mmHg)
Flow rate	50 (42.5 $\leq$ flow $\leq$ 65) ml/min, flow measured by volume
Initialization time	40 seconds (typical, includes power-up and initialization time)
System response time	3.2 seconds (typical, includes module response time and host monitor system response time)
Compensation	The CO <sub>2</sub> module is equipped with a barometric pressure transducer and compensation is triggered at startup or during other events (significant changes in temperature, ambient pressure, etc.). BTPS (standard correction used by Microstream capnography during all measurement procedures for body temperature, pressure, and saturation).
Cyclical pressure	$\leq 10$ kPa (100 cmH <sub>2</sub> O); module operates within specification with overpressure up to 100 cmH <sub>2</sub> O

---



---

**CO<sub>2</sub> specifications (for additional information, refer to the directions for use that accompanies each accessory)**

---

Sampled gas return/disposal	Sampled gases are not returned to the breathing circuit. Exhaled gas is exhausted from the monitor's exhaust port. Dispose of sampled gases according to facility requirements or local regulations.
-----------------------------	--

Calibration interval	Initial: After 1200 operating hours Subsequent: After 4000 operating hours or annually (whichever comes first)
----------------------	---

Periodic service	After 30,000 operating hours
------------------	------------------------------

---

**etCO<sub>2</sub>**

---

Units of measure	mmHg, kPa; user-selectable
------------------	----------------------------

Display range	0 to 150 mmHg (0.0 to 20.0 kPa)
---------------	---------------------------------

Resolution	1 mmHg, 0.1 kPa
------------	-----------------

---

**FiCO<sub>2</sub>**

---

Units of measure	mmHg, kPa; user-selectable
------------------	----------------------------

Display range	0 to 150 mmHg (0.0 to 20.0 kPa)
---------------	---------------------------------

Resolution	1 mmHg, 0.1 kPa
------------	-----------------

---

**IPI**

---

Display range	1 to 10
---------------	---------

---

**RR**

---

Unit of measure	breaths per minute
-----------------	--------------------

Display range	0 to 150 breaths per minute
---------------	-----------------------------

Accuracy	0 to 70 breaths per minute: $\pm 1$ breath per minute 71 to 120 breaths per minute: $\pm 2$ breaths per minute 121 to 150 breaths per minute: $\pm 3$ breaths per minute
----------	--

Resolution	1 breath per minute
------------	---------------------

---

<sup>1</sup> The accuracy specification is maintained to within 4% of the values indicated in the presence of interfering gases in accordance with ISO 21647, clauses 51.101.3 and 101.1.

---

<sup>2</sup> The accuracy specification is maintained to within 4% of the values indicated in the presence of up to 80% helium with up to 15% oxygen when tested in accordance with ISO 21647.

---

<sup>3</sup> The accuracy specification is maintained when tested for drift in accordance with ISO 21647, clause 51.101.2.

---

<b>Alarm limits</b>	<b>Upper limit range of entry</b>	<b>Lower limit range of entry</b>
Systolic	Adult: 30 to 258 mmHg (4.0 to 34.4 kPa). Factory default: 220 mmHg (29.3 kPa). Pediatric: 32 to 160 mmHg (4.3 to 21.3 kPa). Factory default: 145 mmHg (19.3 kPa). Neonate: 27 to 120 mmHg (3.6 to 16.0 kPa). Factory default: 100 mmHg (13.3 kPa).	Adult: 28 to 256 mmHg (3.7 to 34.1 kPa). Factory default: 75 mmHg (10.0 kPa). Pediatric: 30 to 158 mmHg (4.0 to 21.1 kPa). Factory default: 75 mmHg (10.0 kPa). Neonate: 25 to 118 mmHg (3.3 to 15.7 kPa). Factory default: 50 mmHg (6.7 kPa).
Diastolic	Adult: 22 to 235 mmHg (2.9 to 31.3 kPa). Factory default: 110 mmHg (14.7 kPa). Pediatric: 17 to 130 mmHg (2.3 to 17.3 kPa). Factory default: 100 mmHg (13.3 kPa). Neonate: 12 to 105 mmHg (1.6 to 14.0 kPa). Factory default: 70 mmHg (9.3 kPa).	Adult: 20 to 233 mmHg (2.7 to 31.1 kPa). Factory default: 35 mmHg (4.7 kPa). Pediatric: 15 to 128 mmHg (2.0 to 17.1 kPa). Factory default: 35 mmHg (4.7 kPa). Neonate: 10 to 103 mmHg (1.3 to 13.7 kPa). Factory default: 30 mmHg (4.0 kPa).
MAP	Adult: 22 to 255 mmHg (2.9 to 34.0 kPa). Factory default: 120 mmHg (16.0 kPa). Pediatric: 17 to 140 mmHg (2.3 to 18.7 kPa). Factory default: 110 mmHg (14.7 kPa). Neonate: 12 to 110 mmHg (1.6 to 14.7 kPa). Factory default: 80 mmHg (10.7 kPa).	Adult: 20 to 253 mmHg (2.7 to 33.7 kPa). Factory default: 50 mmHg (6.7 kPa). Pediatric: 15 to 138 mmHg (2.0 to 18.4 kPa). Factory default: 50 mmHg (6.7 kPa). Neonate: 10 to 108 mmHg (1.3 to 14.4 kPa). Factory default: 35 mmHg (4.7 kPa).
SpO2	Adult, Pediatric, Neonate: 52% to 100%. Factory default: 100%.	Adult, Pediatric, Neonate: 50% to 98%. Factory default: 90%.
SpHb	Adult, Pediatric, Neonate: 1.5 to 24.5 g/dL (1.5 to 15.0 mmol/L). Factory default: 17.0 g/dL (11.0 mmol/L).	Adult, Pediatric, Neonate: 1.0 to 24.0 g/dL (1.0 to 14.5 mmol/L). Factory default: 7.0 g/dL (4.0 mmol/L).
Pulse rate	Adult: 27 to 300 beats per minute. Factory default: 120 beats per minute. Pediatric: 27 to 300 beats per minute. Factory default: 150 beats per minute. Neonate: 27 to 300 beats per minute. Factory default: 200 beats per minute.	Adult: 25 to 298 beats per minute. Factory default: 50 beats per minute. Pediatric: 25 to 298 beats per minute. Factory default: 50 beats per minute. Neonate: 25 to 298 beats per minute. Factory default: 100 beats per minute.
Temperature	Adult, Pediatric, Neonate: 87.1 to 110.0°F (30.6 to 43.3°C). Factory default: 101.0°F (38.3°C).	Adult, Pediatric, Neonate: 85.1 to 108.0°F (29.5 to 42.2°C). Factory default: 94.0°F (34.4°C).
etCO2	Adult: 2 to 150 mmHg (0.3 to 20.0 kPa). Factory default: 60 mmHg (8.0 kPa). Pediatric: 2 to 150 mmHg (0.3 to 20.0 kPa). Factory default: 60 mmHg (8.0 kPa). Neonate: 2 to 150 mmHg (0.3 to 20.0 kPa). Factory default: 50 mmHg (6.7 kPa).	Adult: 0 to 148 mmHg (0.0 to 19.7 kPa). Factory default: 15 mmHg (2.0 kPa). Pediatric: 0 to 148 mmHg (0.0 to 19.7 kPa). Factory default: 15 mmHg (2.0 kPa). Neonate: 0 to 148 mmHg (0.0 to 19.7 kPa). Factory default: 20 mmHg (2.7 kPa).
FICO2	Adult: 0 to 150 mmHg (0.0 to 20.0 kPa). Factory default: 8 mmHg (1.1 kPa). Pediatric: 0 to 150 mmHg (0.0 to 20.0 kPa). Factory default: 8 mmHg (1.1 kPa). Neonate: 0 to 150 mmHg (0.0 to 20.0 kPa). Factory default: 5 mmHg (0.7 kPa).	None

Alarm limits	Upper limit range of entry	Lower limit range of entry
IPI	None	Adult, Pediatric: 1 to 10. Factory default: 4.
RR	Adult: 5 to 150 breaths per minute. Factory default: 50 breaths per minute. Pediatric: 5 to 150 breaths per minute. Factory default: 50 breaths per minute. Neonate: 5 to 150 breaths per minute. Factory default: 80 breaths per minute.	Adult: 0 to 145 breaths per minute. Factory default: 3 breaths per minute. Pediatric: 0 to 145 breaths per minute. Factory default: 3 breaths per minute. Neonate: 0 to 145 breaths per minute. Factory default: 12 breaths per minute.
RRa	Adult: 5 to 150 breaths per minute. Factory default: 50 breaths per minute.	Adult: 0 to 145 breaths per minute. Factory default: 3 breaths per minute.

## Environmental specifications

Operating temperature	50°F to 104°F (10°C to 40°C)
Transport/storage temperature	-4°F to 122°F (-20°C to 50°C)
Operating altitude	-557 to 10,000 ft. (-170 m to 3,048 m)
Operating humidity	15 to 95% noncondensing
Transport/storage humidity	15% to 95% noncondensing

## Monitor radio

The monitor's radio operates on Welch Allyn FlexNet™ or other 802.11 networks.

<b>Wireless network interface</b>	IEEE 802.11 b/g, 802.11a
<b>Frequency</b>	802.11 b/g: 2.402 GHz to 2.4835 GHz 802.11a: 5.125 GHz to 5.875 GHz
<b>Channels</b>	Up to 14 in 802.11b/g, up to 24 in 802.11a; country-dependent
<b>Security/encryption/authentication</b>	WPA2/AES (either EAP or PSK authentication)
<b>Antenna</b>	Internal multiband PIFA
<b>Wireless data rates</b>	802.11b: 1Mbps or higher during vitals transmission only 802.11a/g: 6Mbps or higher during vitals transmission only (approximately 2 seconds per reading)
<b>Agency approvals</b>	US: FCC Part 15, Class B; C/UL; CE; 47 CFR Part 2.1093, 15.207, 15.209, 15.247, 15.407; FCC OET Bulletin 65C; FIPS 140-2 Level 1 (Connex VSM 6500 and 6800 series, and Connex IWS 8500 series) Europe: CE; EN 50371; EN/ETSI 300 328 V1.7.1, 301 489-1 V1.6.1, 301 489-17 V1.2.1, 301 893 V1.4.1

Canada: RSS-210; RSS-GEN; RSS-102

Hong Kong: HKTA 1039

<b>Protocols</b>	UDP, DHCP, TCP/IP
<b>Data transfer protocols</b>	UDP, TCP/IP
<b>Modulation</b>	OFDM (802.11a/g), DSSS/CCK (802.11b)
<b>Output power</b>	40mW typical, country-dependent
<b>Ancillary IEEE standards</b>	802.11e, 802.11h, 802.11i, 802.11X

Channel restrictions in the 5-GHz band are determined by country.

Marking by the symbol ( ! ) indicates that usage restrictions apply. To ensure compliance with local regulations, be sure the correct country in which the access point is installed is selected. This product can be used with the following restriction(s):

France - Outdoor use is limited to 10 mW EIRP within the band 2454 to 2483.5 MHz.

**Note** Effective Isotropic Radiated Power (EIRP).

**Note** Some countries restrict the use of 5-GHz bands. The 802.11a radio in the monitor uses only the channels indicated by the access point with which the radio associates. The hospital IT department must configure access points to operate with approved domains.

## Configuration options

The monitor is available in multiple configurations.

### Monitors capable of supporting a combination of NIBP, SpO<sub>2</sub>, SpHb, pulse rate, and temperature

Model	Description
6300	Basic. Includes USB and Ethernet connectivity.
6400	Standard. Includes nurse call, Ethernet, and USB connectivity. The radio is optional.
6500	Wireless. Includes all Standard features plus an internal 802.11 a/b/g radio.

### Monitors capable of supporting a combination of CO<sub>2</sub>/RR or RRa, NIBP, SpO<sub>2</sub>, SpHb, pulse rate, and temperature

Model	Description
6700	Standard. Includes nurse call, Ethernet, and USB connectivity. The radio is optional.
6800	Wireless. Includes all Standard features plus an internal 802.11 a/b/g radio.

# Standards and compliance

---

## General compliance and standards

The monitor complies with the following standards:

21 CFR Subchapter H – Medical Devices – US Food and Drug Administration  
 2002 No. 236 – Australian Therapeutic Goods Act  
 93/42/EEC – European Economic Community Medical Devices Directive  
 2007/47/EC – European Economic Community Medical Devices Directive 2007  
 Amendment  
 94/62/EC – European Economic Community Packaging Directive  
 2002/96/EC – European Economic Community Waste Electrical and Electronic  
 Equipment Directive  
 2006/66/EC – European Economic Community Batteries and Accumulators Directive  
 SOR/98-282 – Canadian Medical Devices Regulation  
 IATA DGR – International Air Transport Association Dangerous Goods Regulation  
 United Nations ST/SG/AC.10/11 – Manual of Tests and Criteria, Part III, Sub-Section 38.3

ANSI/AAMI SP10  
 AS/NZS 3200.1.0<sup>1</sup>  
 ASTM D 4332, E 1104  
 CAN/CSA C22.2 NO.601.1<sup>1</sup> CAN/CSA-C22.2 NO.60601-1-2, CSA Z9919  
 EN 1060-1, 1060-3, 1060-4<sup>2</sup>  
 EN/IEC 60601-1, 60601-1-2, 60601-1-4, 60601-1-6, 60601-1-8, 60601-2-30, 60601-2-49,  
 62304, 62366  
 EN/ISO 9919, 13485, 14971, 21647  
 ISTA 2A  
 UL 60601-1<sup>1</sup>



**Directive 2002/96/EC-WEEE:  
 Disposal of noncontaminated electrical and electronic equipment**

This product and its accessories must be disposed of according to local laws and regulations. Do not dispose of this product as unsorted municipal waste. Prepare this product for reuse or separate collection as specified by Directive 2002/96/EC of the European Parliament and the Council of the European Union on Waste Electronic and

<sup>1</sup> Standard is essentially the IEC 60601-1 General standard plus the listed country's National Deviations.

<sup>2</sup> Non-Invasive Sphygmomanometers – Part 1: General Requirements, Part 3. Supplementary Requirements for Electro-Mechanical Blood Pressure Measuring Systems, Part 4: Test Procedures to Determine the Overall System Accuracy of Automated Non-Invasive Sphygmomanometers.

Electrical Equipment (WEEE). If this product is contaminated, this directive does not apply.

For more specific disposal or compliance information, see [www.welchallyn.com/weee](http://www.welchallyn.com/weee), or contact Welch Allyn Customer Service at +44 207 365 6780.

## General radio compliance

The wireless features of this monitor must be used in strict accordance with the manufacturer's instructions as described in the user documentation that comes with the product.

This device complies with Part 15 of the FCC rules and with the rules of the Canadian ICES-003 as described below.

## Federal Communications Commission (FCC)

This device complies with part 15 of the FCC Rules. Operation is subject to the following two conditions:

- This device may not cause harmful interference.
- This device must accept any interference received, including interference that may cause undesired operation.

This equipment has been tested and found to comply with the limits for a Class B digital device, pursuant to Part 15 of FCC Rules. These limits are designed to provide reasonable protection against harmful interference in a residential installation. This equipment generates, uses, and can radiate radio frequency energy. If not installed and used in accordance with the instructions, it may cause harmful interference to radio communications. However, there is no guarantee that interference will not occur in a particular installation. If this equipment does cause harmful interference to radio or television reception, which can be determined by turning the equipment off and on, the user is encouraged to try and correct the interference by one or more of the following measures:

- Reorient or relocate the receiving antenna
- Increase the distance between the equipment and the receiver
- Connect the equipment to an outlet on a circuit different from that to which the receiver is connected
- Consult the dealer or an experienced radio/TV technician for help

The user may find the following booklet prepared by the Federal Communications Commission helpful:

*The Interference Handbook*

This booklet is available from the U.S. Government Printing Office, Washington, D.C. 20402. Stock No. 004-000-0034504.

Welch Allyn is not responsible for any radio or television interference caused by unauthorized modification of the devices included with this Welch Allyn product, or the substitution or attachment of connecting cables and equipment other than specified by Welch Allyn.

The correction of interference caused by such unauthorized modification, substitution, or attachment will be the responsibility of the user.

## Industry Canada (IC) emissions

This device complies with RSS 210 of Industry Canada.

Operation is subject to the following two conditions: (1) this device may not cause interference, and (2) this device must accept any interference, including interference that may cause undesired operation of this device.

L'utilisation de ce dispositif est autorisée seulement aux conditions suivantes: (1) il ne doit pas produire de brouillage et (2) l'utilisateur du dispositif doit être prêt à accepter tout brouillage radioélectrique reçu, même si ce brouillage est susceptible de compromettre le fonctionnement du dispositif.

This Class B digital apparatus complies with Canadian ICES-003.

Cet appareil numérique de la classe B est conforme à la norme NMB-003 du Canada.

## European Union

Czech	Welch Allyn tímto prohlašuje, že tento RLAN device je ve shodě se základními požadavky a dalšími příslušnými ustanoveními směrnice 1999/5/ES.
Danish	Undertegnede Welch Allyn erklærer herved, at følgende udstyr RLAN device overholder de væsentlige krav og øvrige relevante krav i direktiv 1999/5/EF
Dutch	Bij deze verklaart Welch Allyn dat deze RLAN device voldoet aan de essentiële eisen en aan de overige relevante bepalingen van Richtlijn 1999/5/EC.
English	Hereby, Welch Allyn, declares that this RLAN device is in compliance with the essential requirements and other relevant provisions of Directive 1999/5/EC.
Estonian	Käesolevaga kinnitab Welch Allyn seadme RLAN device vastavust direktiivi 1999/5/EÜ põhinõuetele ja nimetatud direktiivist tulenevatele teistele asjakohastele sätetele.
Finnish	Welch Allyn vakuuttaa täten että RLAN device tyyppinen laite on direktiivin 1999/5/EY oleellisten vaatimusten ja sitä koskevien direktiivin muiden ehtojen mukainen.
French	Par la présente, Welch Allyn déclare que ce RLAN device est conforme aux exigences essentielles et aux autres dispositions de la directive 1999/5/CE qui lui sont applicables
German	Hiermit erklärt Welch Allyn die Übereinstimmung des Gerätes RLAN device mit den grundlegenden Anforderungen und den anderen relevanten Festlegungen der Richtlinie 1999/5/EG. (Wien)
Greek	ΜΕ ΤΗΝ ΠΑΡΟΥΣΑ Welch Allyn ΔΗΛΩΝΕΙ ΟΤΙ RLAN device ΣΥΜΜΟΡΦΩΝΕΤΑΙ ΠΡΟΣ ΤΙΣ ΟΥΣΙΩΔΕΙΣ ΑΠΑΙΤΗΣΕΙΣ ΚΑΙ ΤΙΣ ΛΟΙΠΕΣ ΣΧΕΤΙΚΕΣ ΔΙΑΤΑΞΕΙΣ ΤΗΣ ΟΔΗΓΙΑΣ 1999/5/EK
Hungarian	Alulírott, Welch Allyn nyilatkozom, hogy a RLAN device megfelel a vonatkozó alapvető követelményeknek és az 1999/5/EC irányelv egyéb előírásainak.
Italian	Con la presente Welch Allyn dichiara che questo RLAN device è conforme ai requisiti essenziali ed alle altre disposizioni pertinenti stabilite dalla direttiva 1999/5/CE.
Latvian	Ar šo Welch Allyn deklarē, ka RLAN device atbilst Direktīvas 1999/5/EK būtiskajām prasībām un citiem ar to saistītajiem noteikumiem.
Lithuanian	Šiuo Welch Allyn deklaruoja, kad šis RLAN device atitinka esminius reikalavimus ir kitas 1999/5/EB Direktyvos nuostatas.

Malti	Hawnhekk, Welch Allyn, jiddikjara li dan RLAN device jikkonforma mal-htigijiet essenzjali u ma provvedimenti ohrajn relevanti li hemm fid-Dirrettiva 1999/5/EC
Portuguese	Welch Allyn declara que este RLAN device está conforme com os requisitos essenciais e outras disposições da Directiva 1999/5/CE.
Slovak	Welch Allyn týmto vyhlasuje, že RLAN device spĺňa základné požiadavky a všetky príslušné ustanovenia Smernice 1999/5/ES.
Slovene	Šiuo Welch Allyn deklaruoja, kad šis RLAN device atitinka esminius reikalavimus ir kitas 1999/5/EB Direktyvos nuostatas.
Spanish	Por medio de la presente Welch Allyn declara que el RLAN device cumple con los requisitos esenciales y cualesquiera otras disposiciones aplicables o exigibles de la Directiva 1999/5/CE
Swedish	Härmed intygar Welch Allyn att denna RLAN device står i överensstämmelse med de väsentliga egenskapskrav och övriga relevanta bestämmelser som framgår av direktiv 1999/5/EG.



# Guidance and manufacturer's declaration

---

## EMC compliance

Special precautions concerning electromagnetic compatibility (EMC) must be taken for all medical electrical equipment. This device complies with IEC EN 60601-1-2:2007.

- All medical electrical equipment must be installed and put into service in accordance with the EMC information provided in this document and the *Welch Allyn Connex Vital Signs Monitor 6000 Series Directions for Use*.
- Portable and mobile RF communications equipment can affect the behavior of medical electrical equipment.

The monitor complies with all applicable and required standards for electromagnetic interference.

- It does not normally affect nearby equipment and devices.
- It is not normally affected by nearby equipment and devices.
- It is not safe to operate the monitor in the presence of high-frequency surgical equipment.
- However, it is good practice to avoid using the monitor in extremely close proximity to other equipment.

## Emissions and immunity information

For information about electromagnetic compatibility (EMC), see the Welch Allyn website:

[http://www.welchallyn.com/apps/products/product\\_category.jsp?catcode=PMS](http://www.welchallyn.com/apps/products/product_category.jsp?catcode=PMS)



# Warranty

---

Welch Allyn warrants the product to be free of defects in material and workmanship and to perform in accordance with manufacturer's specifications for the period of two years from the date of purchase from Welch Allyn or its authorized distributors or agents.

The warranty period shall start on the date of purchase. The date of purchase is: 1) the invoiced ship date if the device was purchased directly from Welch Allyn, 2) the date specified during product registration, 3) the date of purchase of the product from a Welch Allyn authorized distributor as documented from a receipt from said distributor.

This warranty does not cover damage caused by: 1) handling during shipping, 2) use or maintenance contrary to labeled instructions, 3) alteration or repair by anyone not authorized by Welch Allyn, and 4) accidents.

The product warranty is also subject to the following terms and limitations: Accessories are not covered by the warranty. Refer to the directions for use provided with individual accessories for warranty information.

Shipping cost to return a device to a Welch Allyn Service center is not included.

A service notification number must be obtained from Welch Allyn prior to returning any products or accessories to Welch Allyn's designated service centers for repair. To obtain a service notification number, contact Welch Allyn Technical Support.

THIS WARRANTY IS IN LIEU OF ALL OTHER WARRANTIES, EXPRESS OR IMPLIED, INCLUDING BUT NOT LIMITED TO THE IMPLIED WARRANTIES OF MERCHANTABILITY AND FITNESS FOR A PARTICULAR PURPOSE. WELCH ALLYN'S OBLIGATION UNDER THIS WARRANTY IS LIMITED TO REPAIR OR REPLACEMENT OF PRODUCTS CONTAINING A DEFECT. WELCH ALLYN IS NOT RESPONSIBLE FOR ANY INDIRECT OR CONSEQUENTIAL DAMAGES RESULTING FROM A PRODUCT DEFECT COVERED BY THE WARRANTY.

