

Instructions for Use

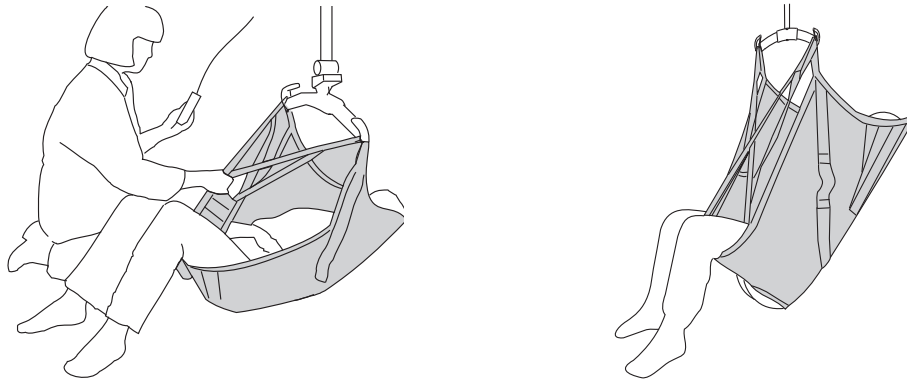

Product Description

Liko Soft Original HighBack Sling is a basic model which is designed to adapt to the patient without individual adjustments and is one of our most used slings.

It provides for a slightly semi-reclined sitting posture and excellent support for the entire body, which is good for patients with reduced head and torso stability. A properly fitted and carefully applied sling will give the patient an excellent sense of security, as well as a high degree of comfort.

Soft Original HighBack Sling can be used in all common lifting situations. The soft reinforced Soft head support provides extra comfortable support for the head in both a sitting and a supine position.

Fabrics

The Soft Original HighBack Sling is available in polyester. Polyester is very durable and have low friction, making the sling easy to apply and easy to remove.

For those who wish a corresponding sling but in a different fabric, it is recommended to use the Original HighBack Sling Mod. 200/210. Original HighBack Sling is available in net polyester, which is recommended if the sling is to be left in the chair after the transfer. For bathing and showering, a plastic-coated net design is available which is water permeable and can easily be wiped. This material dries

quickly and does not chill the patient in the same way as a damp, absorbent fabric would.

The sling's lift straps are always made of durable polyester and are very secure.

Sizes

Soft Original HighBack Sling is available in different sizes. It is important to choose the correct size in order to achieve the highest level of comfort and safety. A sling which is too large increases the risk of the patient sliding out of it, while one which is too small can cut into the groin and cause discomfort.

For larger sizes, a combination with a twin bar 670 can be a good choice.

Leg Supports

Soft Original HighBack Sling has leg supports with reinforced inserts which provide a high degree of comfort, distribute the pressure and prevent the sling from creasing under the thighs.

Suitable lifts

The Soft Original HighBack Sling can be used along with all of Liko's overhead and mobile lifts. You can choose between the overhead lifts LikoGuard™, LikoRall™, and Multirall™ or the mobile lifts Golvo™, Viking™, Uno™, and Liko™ M220/M230.

In this document, the person being lifted is referred to as the patient, and the person helping is referred to as the caregiver.

IMPORTANT!





















Lifting and transferring a patient always involves a certain level of risk. Read the instructions for use for both the patient lift and lifting accessories before use. It is important to completely understand the contents of the instructions for use. The equipment should only be used by trained personnel. Ensure that the lifting accessories are suitable for the lift used. Exercise care and caution during use. As a caregiver, you are always responsible for the patient's safety. You must be aware of the patient's ability to make it through the lifting situation. If something is unclear, contact the manufacturer or supplier.

Table of Contents

Symbol Description	3
Safety Instructions	4
Care and Maintenance	5
Definitions	5
How to Attach a Sling to Different Sling Bars	6
How to Attach a Soft Original HighBack Sling to a Sling Bar with 4 Hooks (Twin Bars and Cross Bars)	7
Lifting from a Sitting Position	7
Lifting to a Sitting Position	9
Removing the Sling in a Chair/Wheel chair	9
Lifting from the Bed.....	10
Lifting to the Bed	10
Removing the Sling when the Patient is Sitting in Bed	10
Removing the Sling when the Patient is Lying in Bed	11
Lifting from the Floor.....	11
Lifting to the Floor	12
Fitting Advice.....	12
Different Sitting Positions	12
Different Ways of Connecting Leg Supports	13
The Patient does not Sit Well in the Sling – Why is This?	13
Shortening Position	13
Accessories.....	14
Overview, Liko Soft Original HighBack Sling, Mod. 26	14
Recommended Combinations	14

Symbol Description

These symbols can be found in this document and/or on the product.

Symbol	Description
	Warning; this situation requires extra care and attention.
	Read instructions for use before use
	CE mark
	Legal manufacturer
	Date of manufacturing
	Product Identifier
	Serial Number
	Medical device
	Do not dry clean
	Do not iron
	Tumble drying
	Do not tumble dry
	Washing Symbol is always in combination with recommended temperature in °C and °F.
	Latex Free
	Periodic inspection
	Do not bleach
	Line drying in shade
	Direction upwards and symbol on outside of equipment.
	Symbol on outside of equipment.
	GS1 Data Matrix Barcode that may contain following information. (01) Global Trade Item Number (11) Production Date (21) Serial Number

Safety Instructions

Before lifting, keep the following points in mind:

- A responsible person within your organization should decide on a case-by-case basis whether one or more caregivers are needed.
- Ensure that the sling selected meets the patient's needs with reference to model, size, fabric and design.
- The total maximum load for a lift system is always determined by the product in the system with the lowest specified maximum load.
- For safety and hygiene reasons, use individual slings.
- Plan the lifting operation so that it can be done as safely and smoothly as possible.
- Check that the lifting accessory hangs vertically and can move freely.
- Although the Liko sling bars are equipped with latches, special caution must be exercised. Before the patient is lifted from the underlying surface, but when the straps are fully extended, make sure the straps are correctly connected to the sling bar hooks.
- Make sure the patient is sitting securely in the sling before transferring to another location.
- Never lift a patient higher off the underlying surface than is needed to complete the lifting and transfer procedure.
- Never leave a patient unattended during a lifting situation.
- Make sure that the wheels on the wheelchair, bed, gurney, etc., are locked during the lifting/transfer operation.
- Always work ergonomically. Use the patient's ability to actively participate in the operations.
- When the sling is not being used, do not place in direct sun light.

 **Incorrect attachment of sling to slingbar may cause severe injury to the patient.**

 **Manually turning the patient in bed may cause injuries to the caregiver.**

 Medical Device Class I Product

PATENT www.hillrom.com/patents

May be covered by one or more patents. See above Internet address.

The Hill-Rom companies are the proprietors of European, US, and other patents and pending patent applications.

Product Changes

Liko's products undergo continuous development, which is why we reserve the right to make product changes without prior notice. Contact your Hill-Rom representative for advice and information about product upgrades.

Design and Quality by Liko in Sweden

Liko is quality certified according to ISO 9001 and its equivalence for the medical device industry, ISO 13485. Liko is also certified according to environmental standard ISO 14001.

Notice to Users and/or Patients in EU

Any serious incident that has occurred in relation to the device, should be reported to the manufacturer and the competent authority of the Member State in which the user and/or patient is established.

Care and Maintenance

Check the sling before each use. Check the following points with regard to wear and damage:

- Fabric
- Straps
- Seams
- Suspension loops

⚠ Do not use damaged lifting accessories.

If anything is unclear, please contact the manufacturer or supplier.

Washing Instructions: Please see the sling's product label and the attached appendix "Care and Maintenance of Liko Slings".

Periodic Inspection

The product must be inspected at least once every 6 months. More frequent inspections might be required if the product is used or washed more often than normal. See Liko's protocol "Periodic Inspection Liko Textile Products". For protocols please contact your Hill-Rom representative.

Expected Life Time

The product has an expected life time of 1-5 years during normal use. Expected life time varies depending on the fabric, use frequency, washing procedure, and weight carried.

Recycling Instructions

The entire product, including laths, padding material, etc. should be sorted as Combustible waste.

Hill-Rom evaluates and provides guidance to its users on the safe handling and disposal of its devices to aid in the prevention of injury, including, but not limited to: cuts, punctures of the skin, abrasions, and any required cleaning and disinfection of the medical device after use and prior to its disposal. Customers should adhere to all federal, state, regional, and/or local laws and regulations as it pertains to the safe disposal of medical devices and accessories.

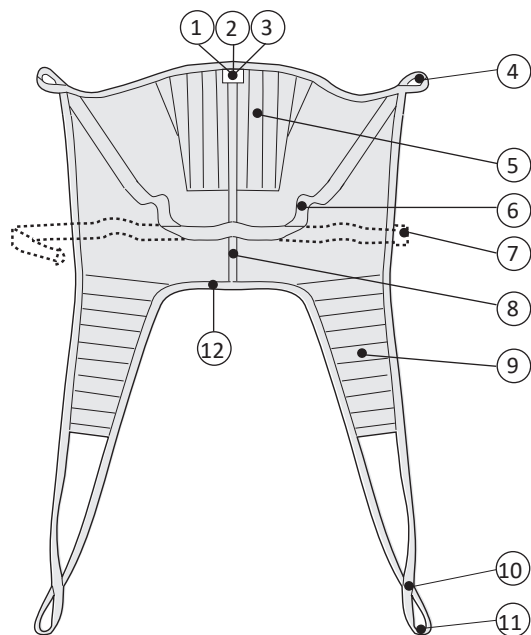

If in doubt, the user of the device shall first contact Hill-Rom Technical Support for guidance on safe disposal protocols.

Definitions

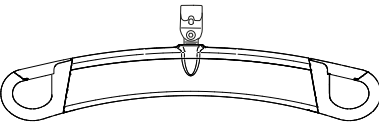
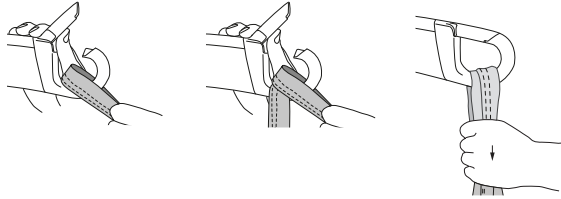
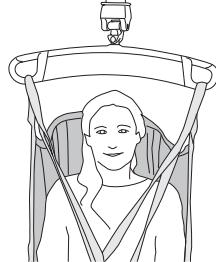
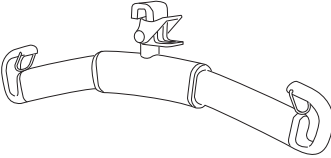
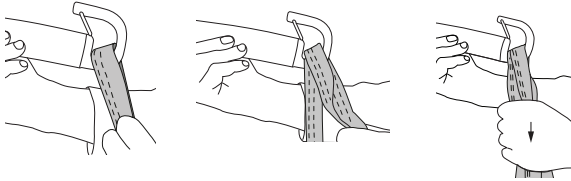

1. Serial number
2. Product label
3. Label: Periodic Inspection
4. Upper strap loop
5. Soft headsupport with laths
6. Handle
7. Belt (where applicable)
8. Center back strap / Size marking
9. Leg support
10. Shortening position
11. Leg support loop
12. Lower edge

How to Attach a Sling to Different Sling Bars

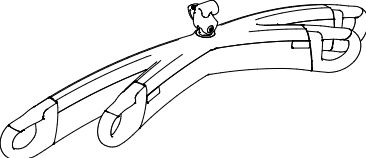
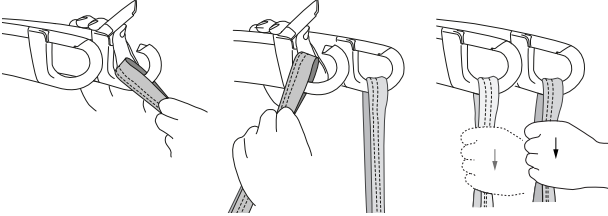
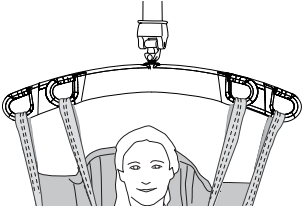
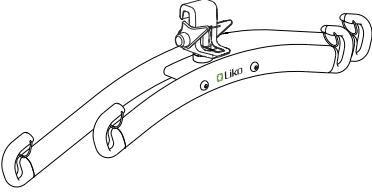
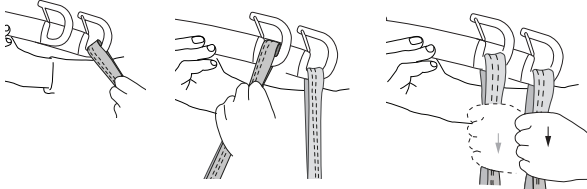
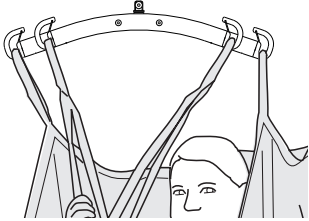
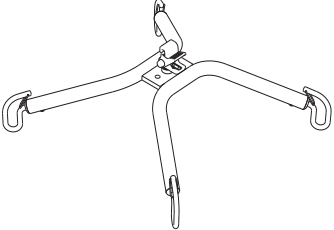
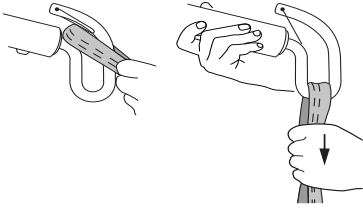
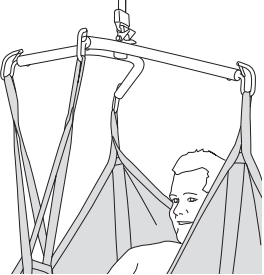
Sling bar	Sling loops to sling bar hooks	Correct
 <p style="text-align: center;">SlingGuard™</p>		
 <p style="text-align: center;">Universal</p>		
 <p style="text-align: center;">SlingGuard™ Twin</p>		
 <p style="text-align: center;">Universal Twin</p>		
 <p style="text-align: center;">Cross-bar</p>		

Wrong!

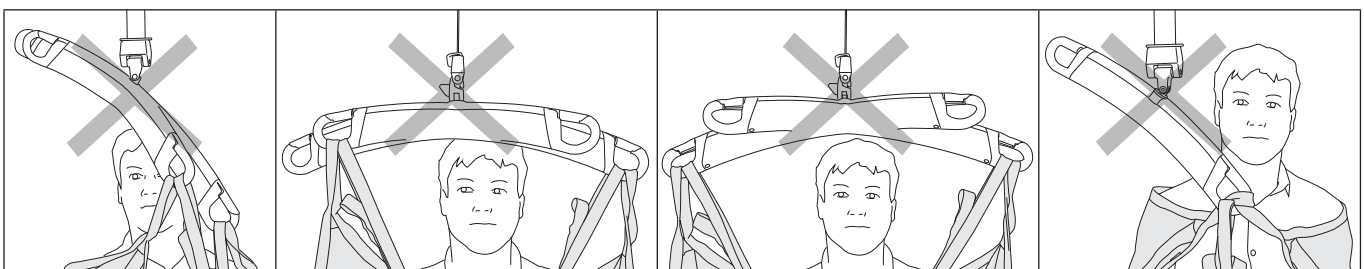

How to Attach a Soft Original HighBack Sling to a Sling Bar with 4 Hooks (Twin Bars and Cross Bars)

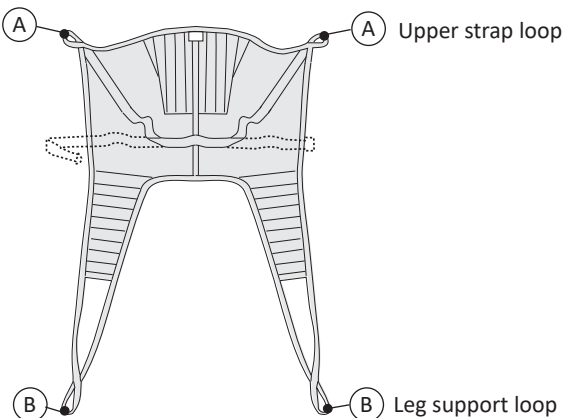
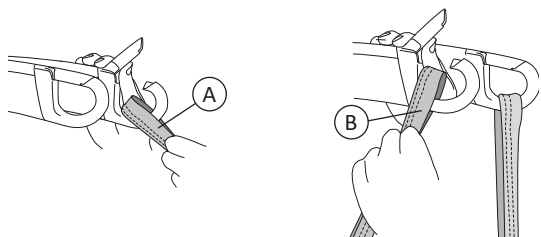
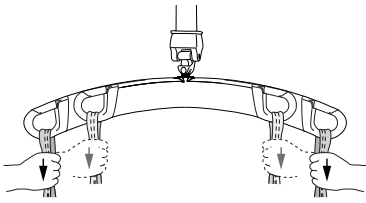
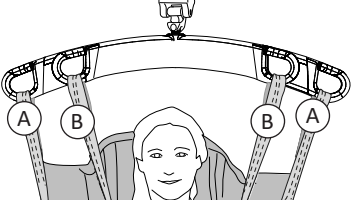
 <p>A Upper strap loop</p> <p>B Leg support loop</p>	<p>1.</p> 
<p>2.</p> 	<p>3.</p>  <p>The illustrations 1, 2, and 3 shows a twin bar but this also applies to a Cross-bar.</p>

Lifting from a Sitting Position

Two caregivers should be used to place the sling in accordance with ergonomic principles. The patient is usually tilted forward during the application, and it is then important that a caregiver stand in front of the patient to prevent him/her from falling forwards.

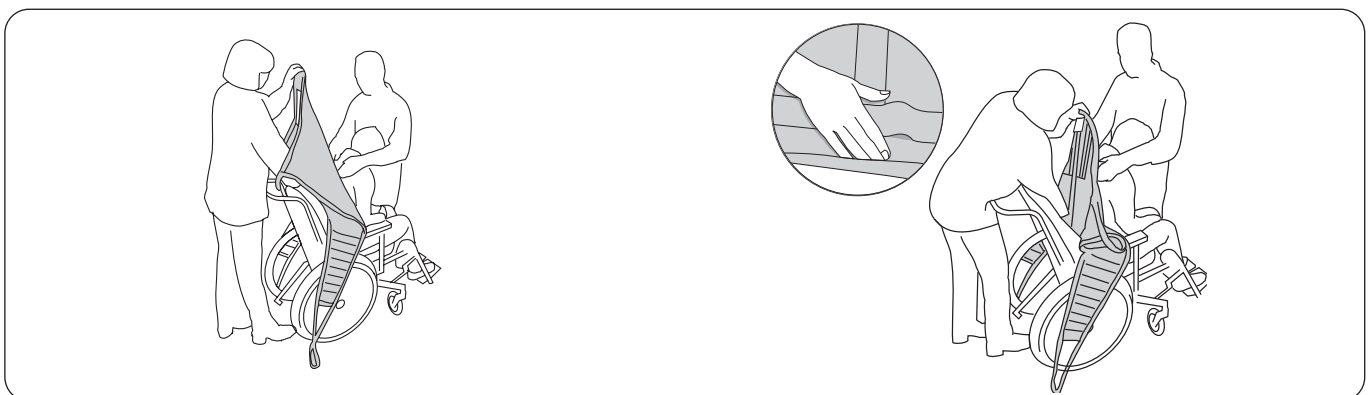

Place the sling behind the patient's back with the product label outwards. Fold up the lower edge of the sling around your finger tips to facilitate guiding the sling into place.

Using the palm of your hand, push the lower edge of the sling down to the level of the patient's coccyx -**this is very important**. **Tip:** Correct positioning is facilitated if the patient leans/is leaned forward slightly.

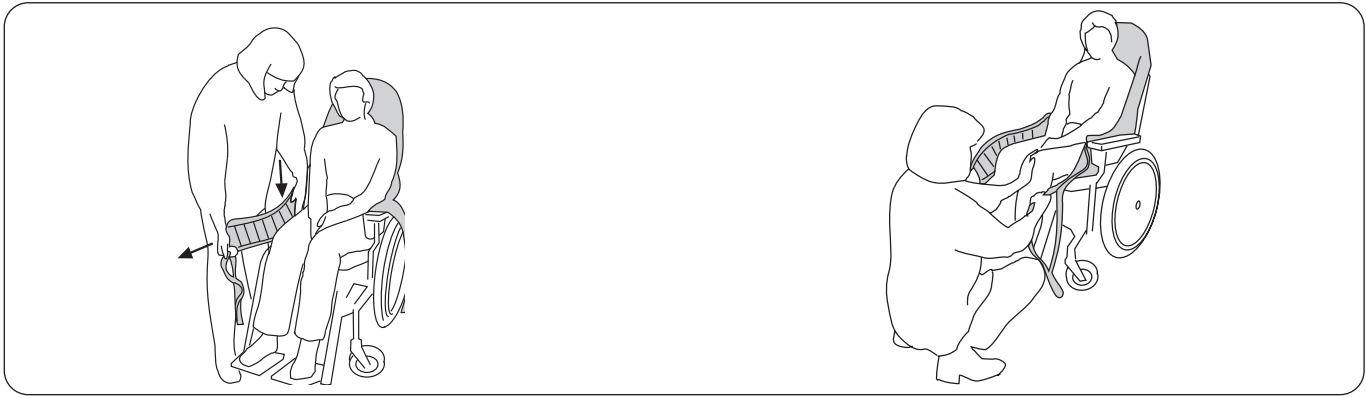

Pull the sling's leg supports forward along the outside of the patient's thighs. Place the palm of your hand between the patient's body and the sling and push the leg support's lower edge down towards the seat. Simultaneously, pull the leg support forward with the other hand to stretch it.

Pull the leg supports forward to smooth out any creases in the back. Check that both leg supports protrude the same distance. **Tip:** A gentle hold under the knee-cap makes it easier to pull the leg supports forward.

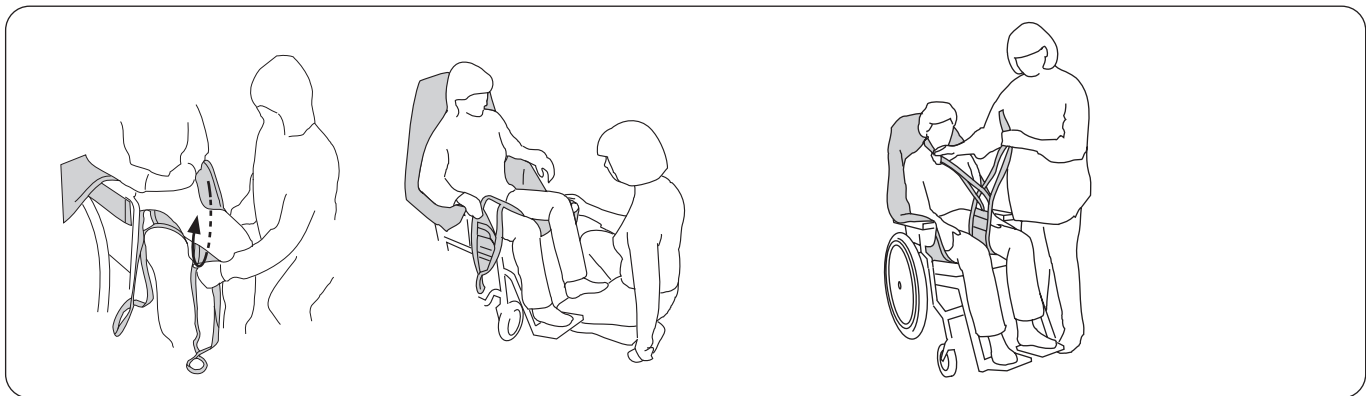

Insert the leg supports under each thigh. Make sure the fabric lies flat and that it reaches properly around the leg. **Tip:** The application of the leg supports is facilitated if the patient's legs are slightly raised from the seat. This can be achieved by placing the patient's feet on the foot-rests or on your own leg, as illustrated.

Prepare the connection of the leg supports. The most common way of applying the sling is with crossed leg supports. For alternative methods, see page 13.

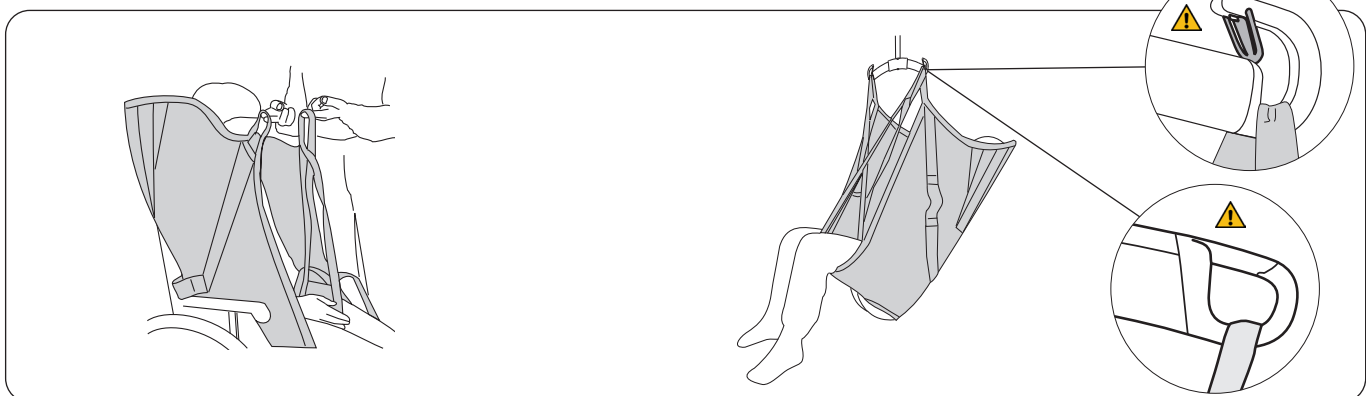

Tip: Check that all suspension loops have the same length, i.e., are at an equal height when they are stretched prior to lifting. Adjust the position of the sling if they are not at an equal height.

First connect the upper strap loops to the sling bar, then the leg support loops. See page 6-7 for instructions on how to attach the sling loops to different sling bars. Lift the patient.

Lifting to a Sitting Position

When placing a patient in a wheelchair, it is important that the patient gets far enough back in the chair to sit well. This can be accomplished in several ways.

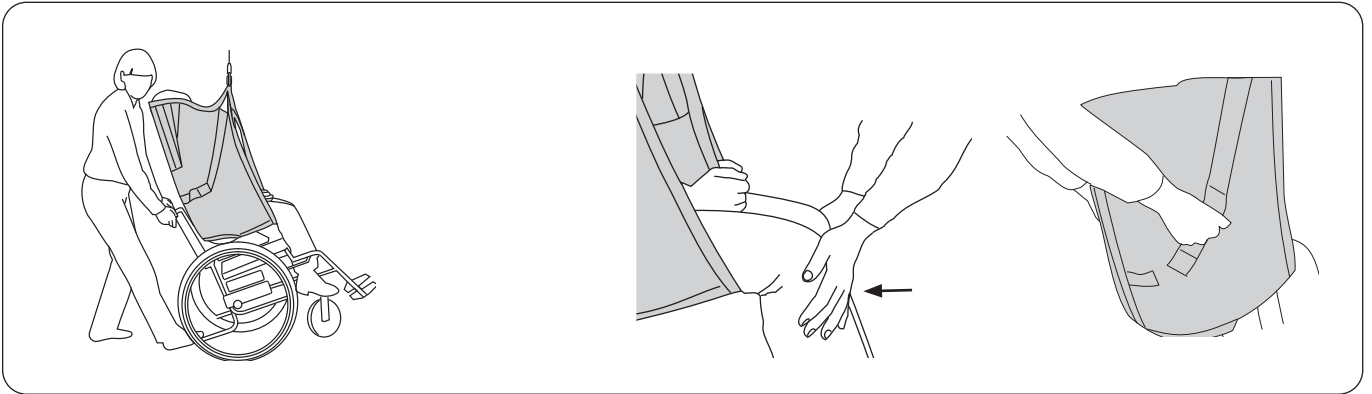

When placing a patient in a wheelchair: Lean the chair backwards during the lowering of the patient. Let the buttocks slide down the backrest during the last part. Control the angle of the wheelchair with your foot on the tipping support.

Alternative: Apply slight pressure under the patient's knees during the lowering sequence, so that the buttocks are guided towards the backrest of the chair. If the sling has handles, these can be used to guide.

⚠ Do not use the handles to lift! Excessive force on the handles can cause the sling to tear.

Removing the Sling in a Chair/Wheelchair

It is recommended to remove the sling after the transfer. If for some reason it is preferable to leave the sling in the chair after transfer, it is recommended to use Original HighBack Sling Mod. 200/210 made of net polyester.

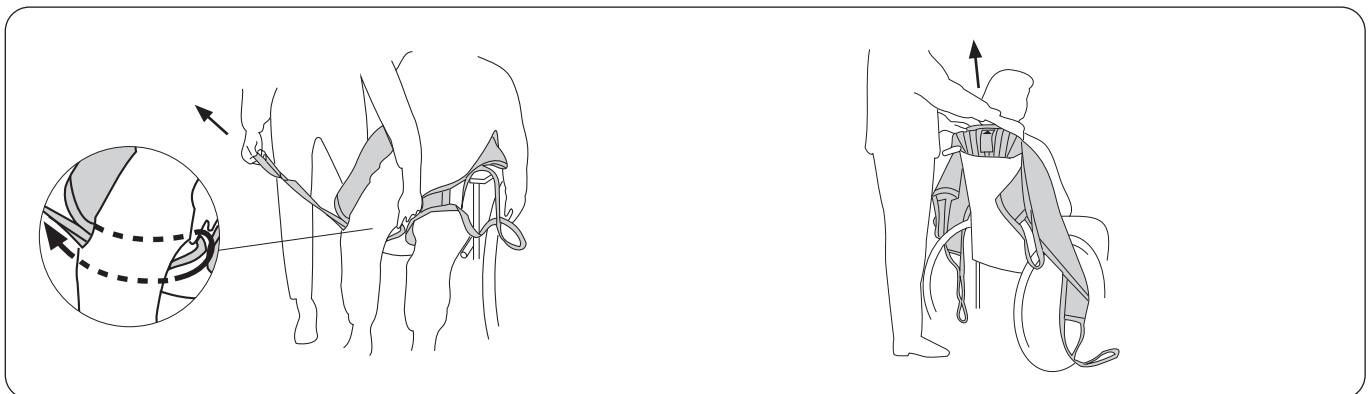

Carefully remove the leg support. The gentlest way of doing this is by pulling out the leg support loops under the fabric part of the leg support.

Remove the sling by carefully pulling it up.

Lifting from the Bed

It is recommended to apply the sling when the patient is lying horizontally, as this is the easiest procedure. In some cases, e.g., if the patient cannot lie horizontally, the sling can be applied with the patient sitting up in bed (see **Alternative method of applying the sling** below).

Think about your own work posture as well as the comfort of the patient. Use the bed's raising and lowering functions.

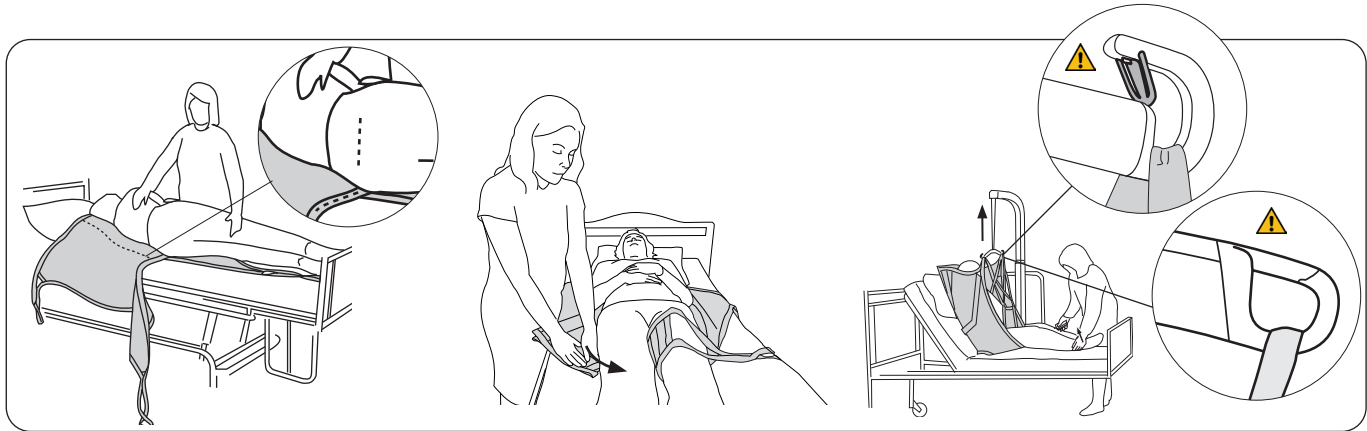

Turn the patient toward you to prevent him or her from falling out of the bed. Insert the sling's edge under the patient with the lower edge **level with the coccyx**. Fold the sling so that its centre back strap corresponds to the patient's spine when the patient is turned back again gently. Carefully pull the sling out from the other side.

Insert the leg supports under the legs. This is best done by pressing the leg support down against the mattress while inserting it under the thigh. Make sure the fabric lies flat and that it reaches properly around the leg. The leg supports can be connected in different ways, see page 13.

Raise the head end of the bed. First connect the upper strap loops to the sling bar, then the leg support loops. See page 6-7 for instructions on how to attach the sling loops to different sling bars. Lift the patient.

Alternative method of applying the sling: Raise the head end of the bed behind the patient. Lay the sling on the bed with the product label facing down towards the mattress. Slide the sling down behind the patient's back so that the lower edge is in level with the coccyx. **Tip!** The application is facilitated if the patient leans/is leaned forward.

Lifting to the Bed

It is recommended to remove the sling after the transfer. If for some reason it is preferable to leave the sling in the bed after transfer, it is recommended to use Original HighBack Sling Mod. 200/210 made of net polyester.

Think about your own work posture as well as the comfort of the patient. Use the bed's raising and lowering functions.

Removing the Sling when the Patient is Sitting in Bed

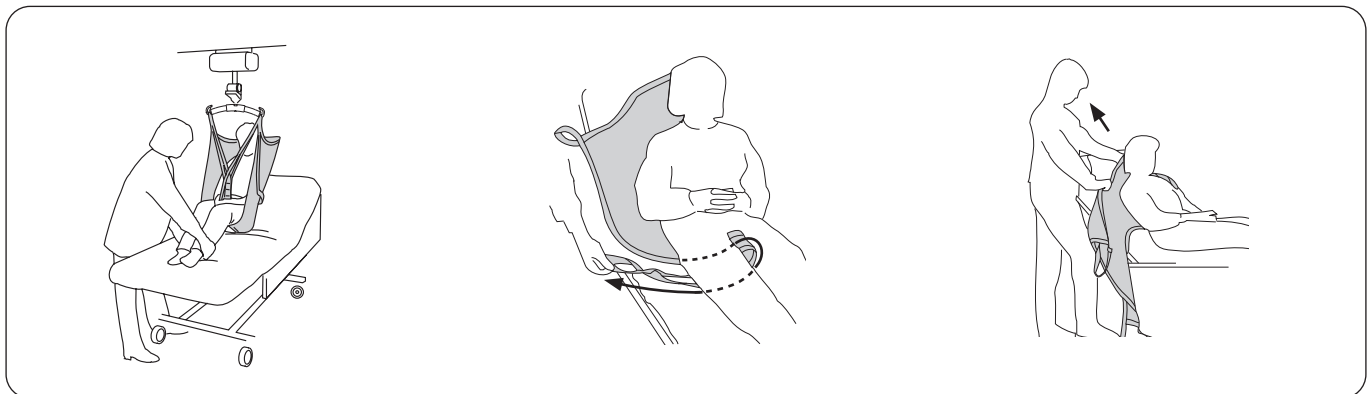

Position the patient above the bed. Raise the head end of the bed for the patient's comfort. Lower the patient onto the bed.

Remove the leg supports by pulling out the leg support loops under the fabric part of the leg support. **Tip:** This is facilitated if the patient's legs are bent.

Remove the sling by carefully pulling it up.

Removing the Sling when the Patient is Lying in Bed

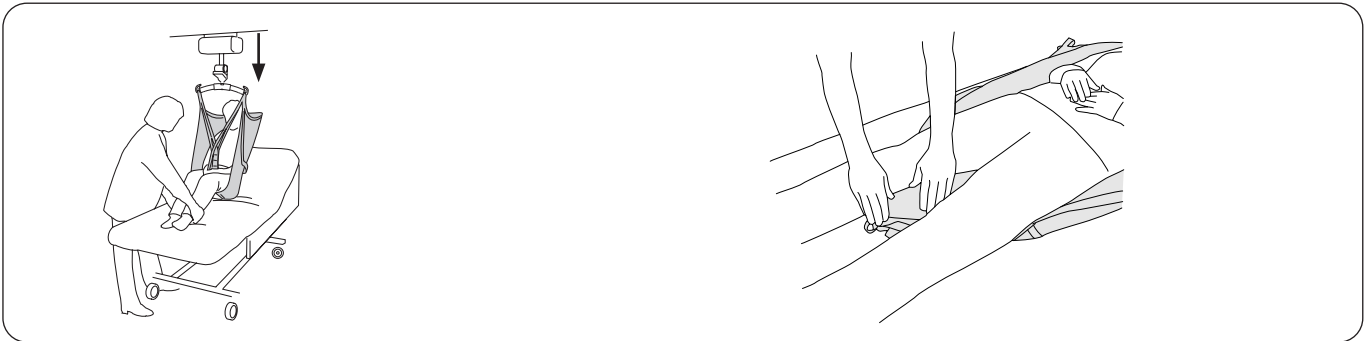

Position the patient above the bed. Raise the head end of the bed for the patient's comfort. Lower the patient onto the bed. Lower the head end.

Place the leg support loops under the leg supports between the patient's legs.

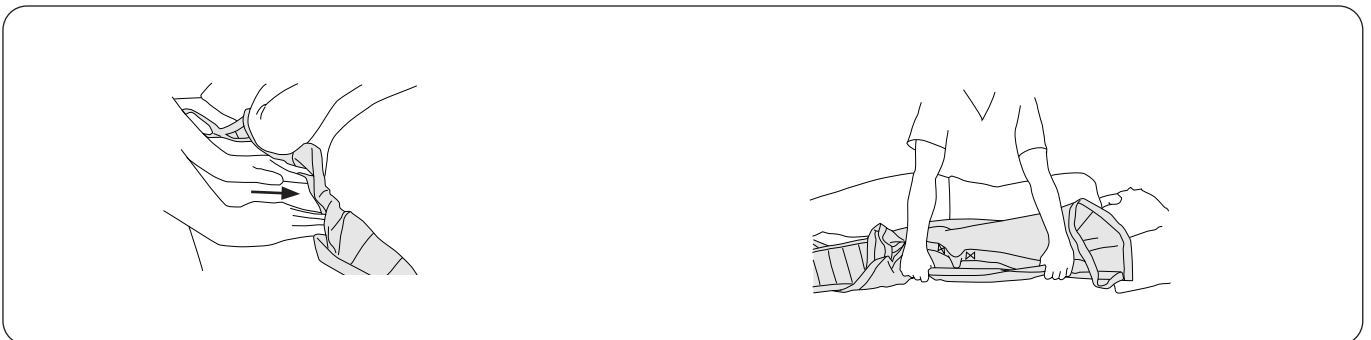

Grasp the edge of the sling. Push in the sling under itself. Press the sling against the mattress and in under the patient.

Carefully turn the patient onto the side. Grasp the sling from below and remove it carefully.

Lifting from the Floor

Lifting from the floor with Liko's mobile lift Golvo™ is described below. The same technique is suitable also for lifting with Liko's other mobile and stationary lifts. Read the Instructions for use for the lift being used.

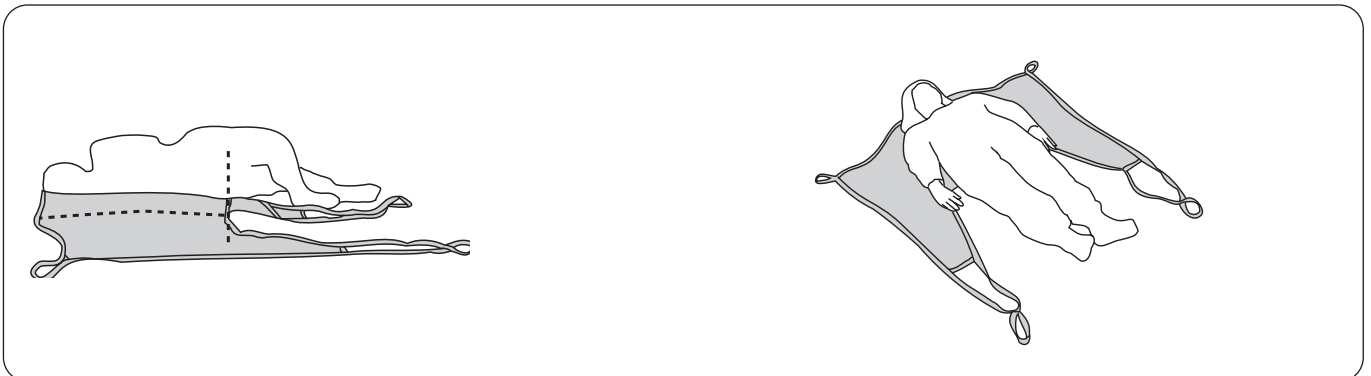

Carefully turn the patient onto the side and place the sling's edge under the patient with the lower edge **level with the coccyx**. Fold the sling so that its centre back strap corresponds to the patient's spine when the patient is turned back again gently. Carefully pull the sling out from the other side.

Check that the sling lies symmetrically under the patient; adjust the position if necessary. Insert the leg supports under the legs.



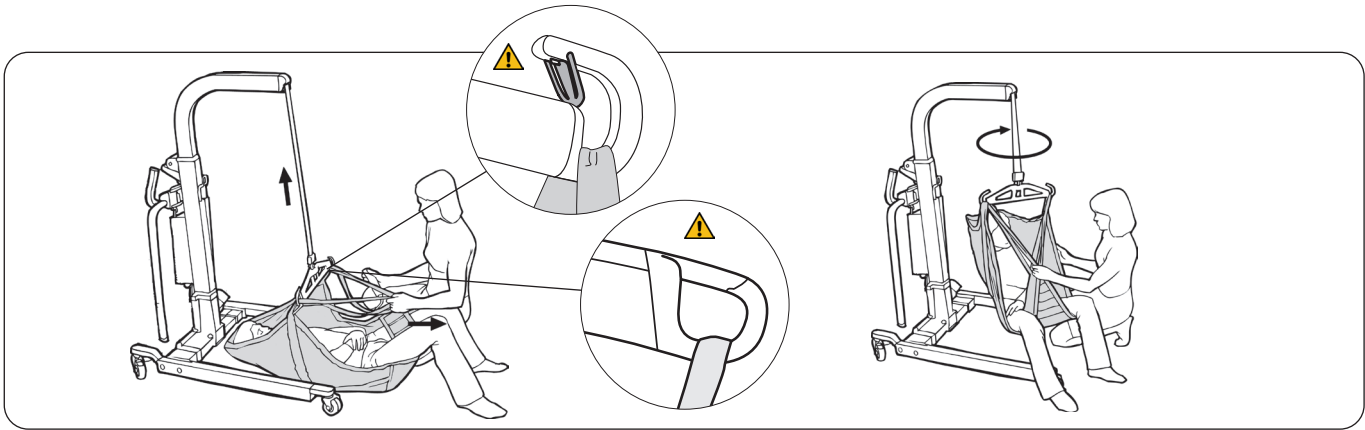

Smooth out the leg supports under the patient's legs. First connect the upper strap loops to the sling bar, then the leg support loops. See page 6-7 for instructions on how to attach the sling loops to different sling bars. Keep the leg supports away from the groin to prevent discomfort to the patient. This is facilitated if the patient bends the legs.

Lift the patient from the floor. The patient can be rotated slightly to avoid the head's getting too close to the mast.

⚠ The mobile lift should be locked when lifting with the patient's head against the lift.

Lifting to the Floor

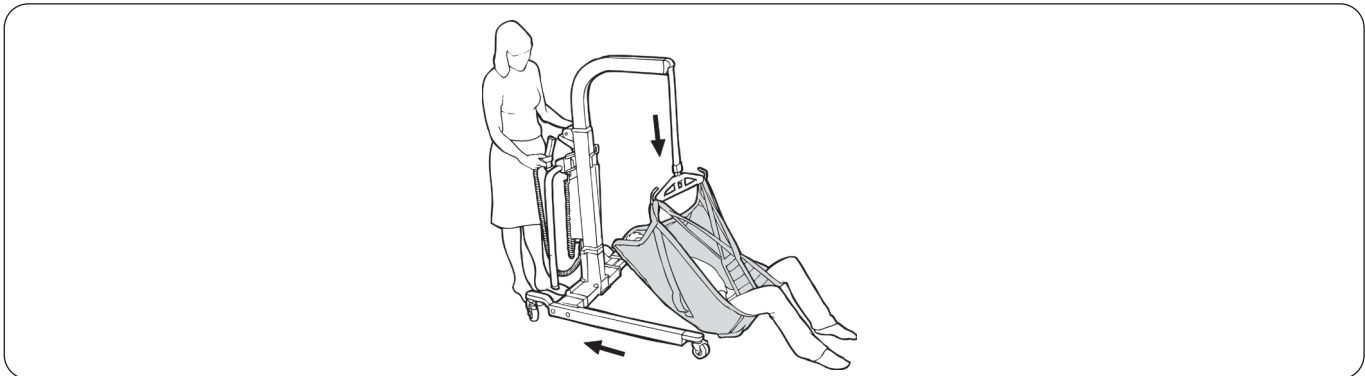

When lifting to the floor, the wheels of the lift should not be locked. When the patient touches the floor, the lift should be pulled backwards to give space for the head. **Tip:** If lifting is to a thinner gym mat, the lift can be pushed in under this mat, so that the mat acts as a soft protection between the lift and the patient. If the sling is to be removed, see "Removing the Sling when the Patient is Lying in Bed", page 11.

Fitting Advice

Different Sitting Positions

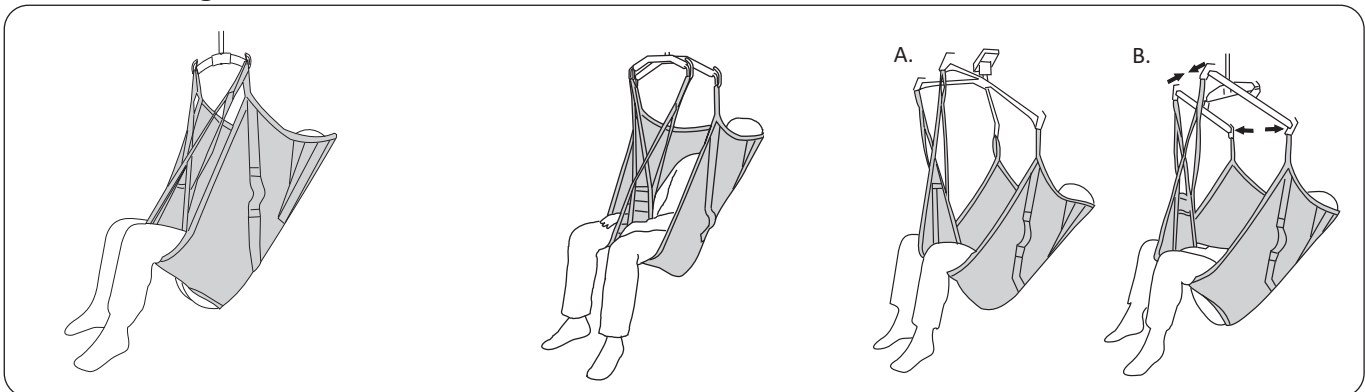

Soft Original HighBack Sling in **two-point suspension** provides for a slightly reclined sitting posture with excellent head support and approx. 90 degrees angle in the hip joint.

Soft Original HighBack Sling in combination with a **twin bar 670** provides larger width at the shoulders than at the leg supports, which is suitable if the patient is large or sensitive to pressure to the shoulders.

A. In combination with Liko **Cross-bar** a slightly more reclined posture and a larger angle at the hip joint is obtained.

B. In combination with **SideBars** a slightly more reclined posture and a larger width at the shoulders than at the leg supports is provided, which is suitable if the patient is sensitive to pressure to the shoulders.

Different Ways of Connecting Leg Supports

Before a connection alternative is chosen, an individual assessment should be performed to anticipate possible risks.

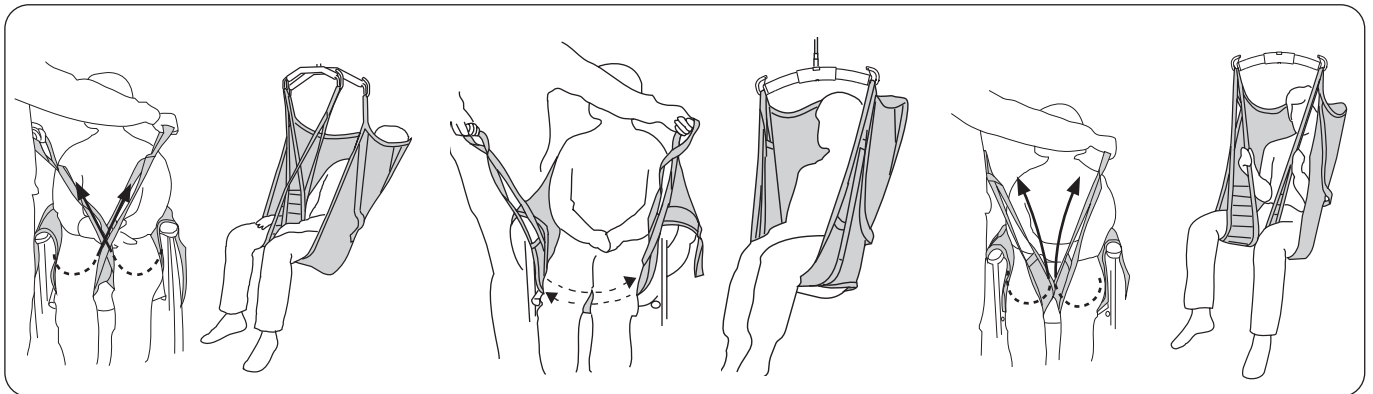

Crossed-over leg supports.

The most common way of applying the sling. One leg support loop is passed through the other before the loops are connected to the sling bar.

Overlapped under both thighs.

This can be appropriate, for example when lifting a patient with amputated legs.

Tip: In order to avoid the patient's sitting posture being too reclined, Extension Loops can be attached to the leg support loops.

Each leg support connected separately to the sling bar.

This can be appropriate when lifting patients with particularly sensitive genitals.

⚠ **Increased risk of sliding out.**

The Patient does not Sit Well in the Sling – Why is This?

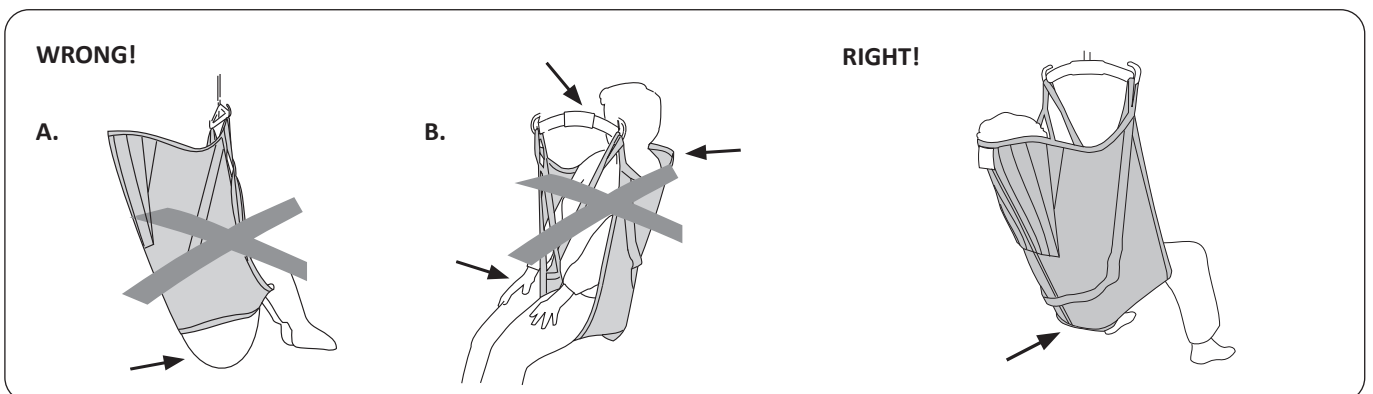

A. Risk of sliding out. The buttocks hang down. The sling may be too large. It can also be due to the fact that the sling has not been pulled down the patient's back sufficiently.

Before lifting, check that the lower edge is stretched and that the fabric reaches properly around the legs.

B. A sling that is too small can cause the leg supports to cut into the groin, causing discomfort and the sling bar to be too close to the face and/or the back to get insufficient support.

The lower edge of the sling is at the same level as the coccyx. The leg supports are properly positioned under the legs.

Shortening Position

In certain cases, it can be advantageous to shorten the leg support loop for the patient to sit well in the Soft Original HighBack Sling. The shortening position can be used temporarily in order to test for the right length, but extended use may damage the bartacks. If you want to shorten the leg support loop for long-term use however, it is recommended that you tie a knot in the loop to shorten it about 10 cm (4 in). In this case, it is the outer leg support loop which should be connected to the sling bar.

Accessories

Extension Loop, green, 12 cm (5 in)
 Extension Loop, green 22 cm (9 in)
 Extension Loop, grey, 12 cm (5 in)
 Extension Loop, grey, 22 cm (9 in)

Prod. No. 3691102
 Prod. No. 3691103
 Prod. No. 3691302
 Prod. No. 3691303

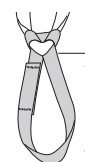

- 2 = 12 cm (5 in)
 - 3 = 22 cm (9 in)

Overview Liko™ Soft Original HighBack Sling, Mod 26

Product	Prod. No.	Size		Patient's Weight ¹	Max. Load ²
Soft Original HighBack Sling	3526111	MS	Medium Slim (slim adult)	30-50 kg (66-110 lbs)	200 kg (440 lbs)
Soft Original HighBack Sling	3526115	M	Medium	40-80 kg (88-176 lbs)	200 kg (440 lbs)
Soft Original HighBack Sling	3526116	L	Large	70-120 kg (154-264 lbs)	200 kg (440 lbs)
Soft Original HighBack Sling	3526117	XL	Extra Large	110-250 kg (242-550 lbs)	500 kg (1,100 lbs)
Soft Original HighBack Sling	3526118	XXL	Extra Extra Large	200- kg (440- lbs)	500 kg (1,100 lbs)

¹ The indicated patient weight is a guideline only – there may be deviations.

² To maintain maximum load, lift/accessories intended for the same load or more are required.

Material

Soft Original HighBack Sling is made of polyester

Recommended Combinations

Recommended combinations of the Liko Soft Original HighBack Sling and Liko's sling bars:	Mini 220	Sling bar 350 ³	Standard 450	Sling bar 450 ¹	Sling bar 600 ⁴	Twin bar 670 ²	Sling Cross-bar 450	Sling Cross-bar 670	Univ. SideBars + Universal 350	Univ. SideBars + Universal 450
	Soft Original HighBack Sling, MS	3	2	1	1	3	2	1	1	1
Soft Original HighBack Sling, M	3	2	1	1	3	1	1	1	2	1
Soft Original HighBack Sling, L	3	3	1	1	3	1	2	1	2	1
Soft Original HighBack Sling, XL	4	3	2	1	3	1	2	1	2	1
Soft Original HighBack Sling, XXL	4	4	4	3	3	2	4	1	4	2

¹ Sling bar 450 relates to Universal SlingBar 450 Prod. No. 3156075, 3156085, and 3156095, and also SlingGuard 450 Prod. No. 3308020 and 3308520.

² Twin bar 670 relates to Universal TwinBar 670 Prod. No. 3156077, and 3156087, and also SlingGuard 670 Twin Prod. No. 3308040 and 3308540.

³ Sling bar 350 relates to Universal SlingBar 350 Prod. No. 3156074, 3156084, and 3156094.

⁴ Sling bar 600 relates to Universal SlingBar 600 Prod. No. 3156076 and 3156086.

Explanation: 1 = Recommended, 2 = May work, 3 = Not advised, 4 = Inappropriate

Other Combinations

Combinations of accessories/products other than those recommended by Liko can result in risks for the safety of the patient.



www.hillrom.com

Liko AB
 Nedre vägen 100
 975 92 Luleå, Sweden
 +46 (0)920 474700

Liko AB is a subsidiary of Hill-Rom Holdings, Inc.

Enhancing outcomes for patients and their caregivers:

